

CLASSIC BATTLETECH

TM

TECHNICAL™
READOUT:

3

0

3

9

THE SUCCESSION WARS

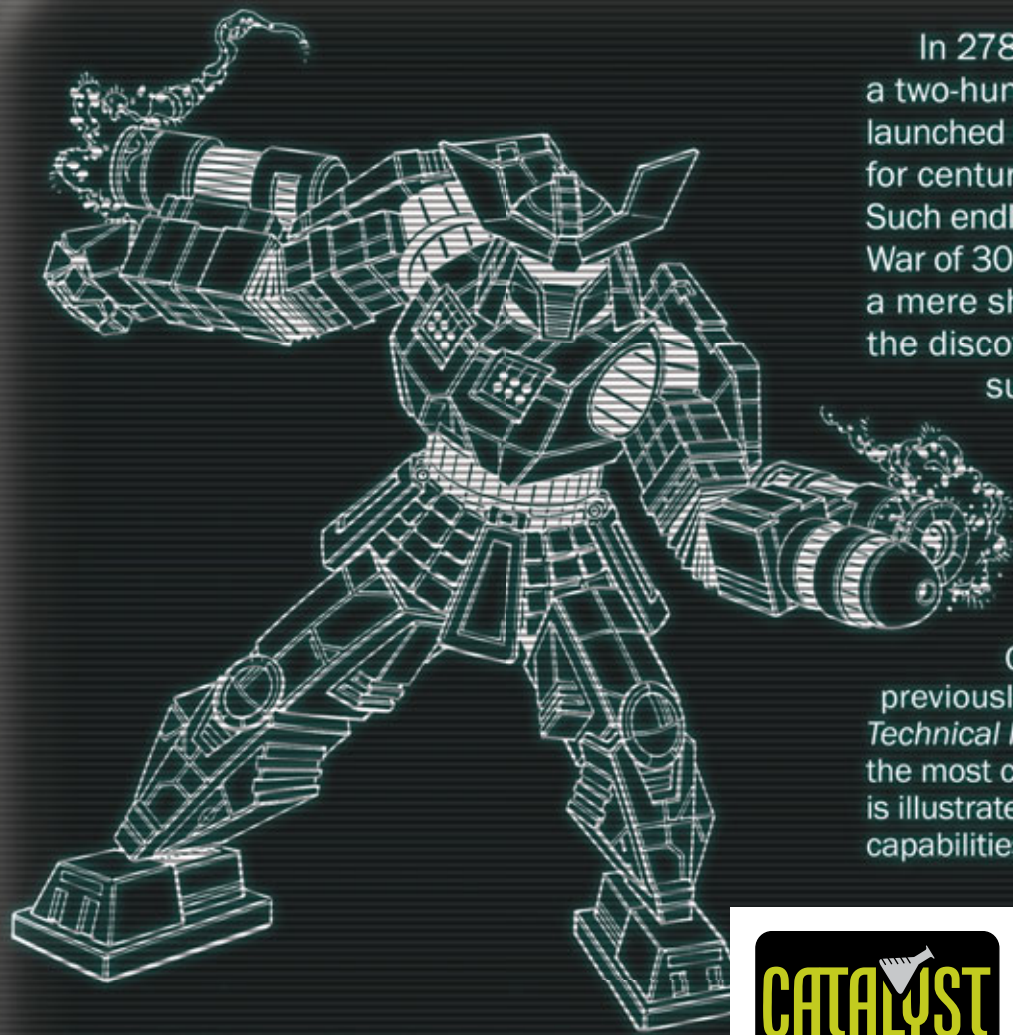

In 2781 the Star League was officially abandoned, ending a two-hundred-year-long Golden Age. The Successor Lords launched a series of massive conflicts in 2785 that would rage for centuries and become known as the Succession Wars. Such endless warfare took its toll, and by the Fourth Succession War of 3028 the technology employed on the battlefields was a mere shadow of the height of the Star League. However, the discovery of the Helm Memory Core started to unlock such sought-after secrets, with new BattleMechs and experimental technologies emerging for the first time in centuries.

Classic BattleTech Technical Readout: 3039™ is the perfect first Technical Readout companion to the *Classic BattleTech Introductory Box Set*. Combining the 'Mechs, vehicles, and aerospace fighters previously found in *Technical Readout: 3025, Revised* and *Technical Readout: 3026, Revised*, this volume features some of the most common units of the Succession Wars. Each machine is illustrated in detail, accompanied by a description of its history, capabilities, game stats, and some of the unit's most famous pilots.

FOR USE WITH
CLASSIC
BATTLETECH™



Under License From



©2008 WizKids, Inc. All Rights Reserved. Classic BattleTech Technical Readout: 3039, Classic BattleTech, BattleTech, BattleMech, 'Mech, and WK Games are registered trademarks and/or trademarks of WizKids, Inc. in the United States and/or other countries. Catalyst Game Labs and the Catalyst Game Labs logo are trademarks of InMediaRes Productions, LLC. Printed in Canada.

WEBSITE: CATALYSTGAMELABS.COM



T E C H N I C A L

R E A D O U T

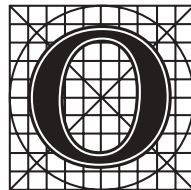

CATALYST GAME LABS

TABLE OF CONTENTS

INTRODUCTION	4	Panther	114	FIRST IN CENTURIES...	222
VEHICLES	6	Assassin	116	Raven	224
Ferret Light Scout VTOL	8	Cicada	118	Wolfhound	226
Savannah Master Hovercraft	10	Clint	120	Hatchetman	228
Swift Wind Scout Car	12	Hermes II	122	Cataphract	230
Armored Personnel Carriers	14	Vulcan	124	Hatamoto-Chi	232
J-27 Ordnance Transport	18	Whitworth	126	Daboku	234
Mobile Army Surgical Hospital	20	Blackjack	128	Sai	236
Packrat Long Range Patrol Vehicle	22	Vindicator	130	STAR LEAGUE	238
Skulker Wheeled Scout Tank	24	Centurion	132	Thorn	240
Warrior H-7 Attack Helicopter	26	Enforcer	134	Flea	242
Harasser Missile Platform	28	Hunchback	136	Hornet	244
J. Edgar Light Hover Tank	30	Trebuchet	138	Mongoose	246
Mobile HQ	32	Dervish	140	Falcon	248
Scorpion Light Tank	34	Dragon	142	Hermes	250
Sea Skimmer Hydrofoil	36	Quickdraw	144	Hussar	252
Coolant Truck	38	Catapult	146	Sentinel	254
Karnov UR Transport	40	JagerMech	148	Wyvern	256
Hunger Light Support Tank	42	Grasshopper	150	Crab	258
Pegasus Scout Hovertank	44	Orion	152	Kintaro	260
Saladin Assault Hover Tank	46	Awesome	154	Champion	262
Saracen Medium Hover Tank	48	Charger	156	Lancelot	264
Scimitar Medium Hover Tank	50	Victor	158	Bombardier	266
Striker Light Tank	52	Zeus	160	Guillotine	268
Engineering Vehicle	54	Stalker	162	Black Knight	270
Hetzer Wheeled Assault Gun	56	Cyclops	164	Flashman	272
Goblin Medium Tank	58	Banshee	166	Thug	274
Condor Heavy Hover Tank	60	Atlas	168	Highlander	276
Drillson Heavy Hover Tank	62	CONVENTIONAL FIGHTERS	170	King Crab	278
Maxim Heavy Hover Transport	64	Boomerang Spotter Plane	172	PROJECT PHOENIX	280
Vedette Medium Tank	66	Angel Light Strike Fighter	174	Locust	281
Bulldog Medium Tank	68	Boeing Jump Bomber	176	Stinger	282
Hi-Scout Drone Carrier	70	Guardian Fighter	178	Wasp	283
LRM/SRM Carrier	72	Defender Medium Strike Fighter	180	Valkyrie	284
Manticore Heavy Tank	74	Meteor Heavy Strike Fighter	182	Ostscout	285
Pike Support Vehicle	76	'Mechbuster	184	Phoenix Hawk	286
Mobile Long Tom Artillery	78	Planelifter Air Transport	186	Griffin	287
Rommel/Patton Tank	80	AEROSPACE FIGHTERS	188	Scorpion	288
Monitor Naval Vessel	82	Seydlitz	190	Shadow Hawk	289
Von Luckner Heavy Tank	84	Cheetah	192	Wolverine	290
Demolisher Heavy Tank	86	Thrush	194	Ostroc	291
Partisan Heavy Tank	88	Sparrowhawk	196	Ostsol	292
Schrek PPC Carrier	90	Sholagar	198	Rifleman	293
SturmFeur Heavy Tank	92	Corsair	200	Crusader	294
Ontos Heavy Tank	94	Samurai	202	Thunderbolt	295
Behemoth Heavy Tank	96	Transit	204	Archer	296
Neptune Submarine	98	Stingray	206	Warhammer	297
BATTLEMECHS	100	Lucifer	208	Marauder	298
Commando	102	Shilone	210	Goliath	299
Javelin	104	Transgrasser	212	BattleMaster	300
Spider	106	Slayer	214	Longbow	301
UrbanMech	108	Chippewa	216	Marauder II	302
Firestarter	110	Riever	218	GENERAL SIZE COMPARISON CHART	303
Jenner	112	Stuka	220		

TECHNICAL READOUT: 3039

TECHNICAL READOUT: 3025

Illustrations

Duane Loose
David R. Deitrick

Writing

Blaine L. Pardoe Dale L. Kemper
Boy F. Petersen, Jr. Shaun Duncan
Anthony Pryor

BattleTech Statistics

L.R. Butch Leeper Forest Brown
L. Ross Babcock III Kevin Stein
Jordan Weisman

Editorial Staff

Editor-in-Chief
L. Ross Babcock III
Senior Editor
Donna Ippolito
Editor
Todd Huettel

Production Staff

Production Managers
Jordan K. Weisman
Karen Vander Mey
Art Director
Dana Knutson
Graphic Design
Jordan K. Weisman
Cover Art
Dana Knutson
Typesetting
Tara Gallagher
Layout and Pasteup
Tara Gallagher Todd F. Marsh
Dana Knutson John Tylk

Additional Help

Dave Wylie Butch Leeper
Clare Hess

Original Technical Readout: 2750 material by

Clare W. Hess Blaine L. Pardoe
Dale L. Kemper Boy F. Petersen, Jr.
Jim Long

TECHNICAL READOUT: 3026

Writing and Design

Kevin Stein
Sam Lewis

Development

Sam Lewis

Editorial Staff

Editor-in-Chief
L. Ross Babcock III
Senior Editor
Donna Ippolito
Editor
Todd Huettel

Production Staff

Production Managers
Jordan K. Weisman
Tara Gallagher
Art Director
Dana Knutson
Cover Art
Duane Loose
Vehicle Design and Illustration
Duane Loose
Equipment Design and Illustration
Steve Venters
Typesetting and Layout
Tara Gallagher
Pasteup
Todd F. Marsh

TECHNICAL READOUT: 3039

Writing

Herb A. Beas II
Randall N. Bills
Ken' Horner
Kevin Killiany
Nick Marsala
David McCulloch
Mike Miller
Ben Rome
Jason Schmetzer
Chris Wheeler

Product Development

Randall N. Bills
Assistant Development
Mike Miller
Chris Wheeler

Production Editing

Jason M. Hardy

BattleTech Line Developer

Herb A. Beas II

Production Staff

Art Direction
Randall N. Bills
Cover Art
Doug Chaffee
Cover Design
Ray Arrastia
Layout
Ray Arrastia
Illustrations
Doug Chaffee
David R. Deitrick
Dana Knutson
Chris Lewis
Kevin Long
Duane Loose
Mike Nielson
Classic BattleTech Logo
Shane Hartley
Steve Walker

Proofers

Rich Cencarik, Christopher K. Searls, and Patrick Wynne.

Special Thanks

To the stalwart crew of Chris Wheeler and Mike Miller, who once more tackled a huge amount of work on this product so I could concentrate on cool projects to come!

©2008 WizKids, Inc. All Rights Reserved. Classic BattleTech Technical Readout:3039, Classic BattleTech, BattleTech, 'Mech, BattleMech, MechWarrior and WK Games logo are registered trademarks and/or trademarks of WizKids, Inc in the United States and/or other countries. No part of this work may be reproduced, stored in a retrieval system, or transmitted in any form or by any means, without the prior permission in writing of the Copyright Owner, nor be otherwise circulated in any form other than that in which it is published.

Published by Catalyst Game Labs,
an imprint of InMediaRes Productions, LLC
PMB 202 • 303 91st Ave NE • G701 •
Lake Stevens, WA 98258
Version 1.0 (January 2008), based on First Printing

FIND US ONLINE:

Precentor_martial@classicbattletech.com
(e-mail address for any
Classic BattleTech questions)
<http://www.classicbattletech.com>
(official Classic BattleTech web pages)
<http://www.CatalystGameLabs.com>
(Catalyst web pages)
<http://www.wizkidsgames.com/mechwarrior/>
(official MechWarrior web pages)
<http://www.wizkidsgames.com>
(WizKids web pages)
<http://www.battlecorps.com/catalog>
(online ordering)

Victor,
Several years ago I passed to you an historical treatise covering the *War of 3039* compiled by General Caradoc Trevena. At that time, General Trevena also sent me a rough draft of a manuscript to act as a companion volume to that work.

An amalgam of the ComStar documents *Technical Readout: 3025* and *Technical Readout: 3026*, the manuscript built off of the great work of Wolfnet and tried to further erase the blatant errors introduced by ComStar. However, the document as generated by General Trevena went much further. The revised Dragoons documents were relatively un-touched in their publications, leaving them as if they had been published in the years 3025 and 3026 respectively. However, as we know, the time period from 3025 until 3039 saw momentous changes in the Inner Sphere. Of particular note was the discovery just before the start of the Fourth Succession Wars of the Helm Memory Core that contained lost Star League technology; the core quickly circulated to all the Great Houses, and they poured resources into unlocking its secrets.

By the launch of the War of 3039, many newly rediscovered technologies were starting to make an appearance, even if they were simply jury-rigged in the field. ComStar, for its own purposes that Trevena delves into in his *War of 3039* treatise, unlocked its vault of hidden Star League designs and provided many of them to House Kurita. And for the first time in centuries, brand new machines of war started coming off production lines.

All of this laid the groundwork for the War of 3039. This is the perspective that General Caradoc attempted to convey with his *Technical Readout: 3039*. With the current events of the Inner Sphere, I believe this document presents an important picture of a time period that is still relevant; the War of 3039 planted the seeds that the Clan Invasion further watered, leading to the current glut of technologies that are wreaking such havoc during the Jihad. What's more, a close examination of some of the personalities noted in this document will reveal important connections to the Jihad; threads that could be critical chinks in numerous factions' armor.

The start of the Jihad and the last desperate years removed this work from my mind. However, despite the centuries-old status of many of these designs, they still represent the most common war machines on the battlefield, despite the numerous upgrade variants of these vehicles and 'Mechs; variants noted by Wolfnet in their *Technical Readout: 3050 Upgrade* and *Technical Readout: 3058 Upgrade* documents. Or even the seeming legion of brand new designs noted in such documents as *Technical Readout: 3055 Upgrade*, *Technical Readout: Project Phoenix*, and so on.

As before, I commend this manuscript to your hands. While it may appear obscure and a relic from an era that seems long lost, I know it will be of worth. As Captain Nikoli so succinctly stated in Wolfnet's *Technical Readout: 3050 Upgrade* document, "Just as knowing an enemy is critical, knowing the genesis of today's technologies can also be important."

—Anastasius Focht
12 November 3073

GAME NOTES

Players can use the *Vehicle and Infantry QSR* rules of the *Classic BattleTech Introductory Rulebook* to easily play most of the vehicles in this product. The complete rules for using vehicles, as well as fighters (both conventional and aerospace), in *Classic BattleTech* game play can be found in *Classic BattleTech Total Warfare*, while the rules for the construction of such units can be found in *Classic BattleTech TechManual*. Additionally, note that some designs were modified from previous publications to make them fully compatible with the construction rules as presented in *TechManual*.

While the primary game stats of most of the BattleMechs listed in *Technical Readout: 3039* are constructed using the *Introductory Rules* as presented in the *Introductory Rulebook* of the *Classic BattleTech Introductory Box Set*, some of the variants mentioned are constructed with weaponry found in *Total Warfare*; the construction rules for said equipment can be found in the *TechManual*.

Several units mount weapons and/or equipment not found in *Total Warfare* or *TechManual*, or mount equipment they cannot mount under those rules sets. They are: Swift Wind Scout Car, Mobile HQ, Hi-Scout Drone Carrier, Mobile Long Tom Artillery and *Raven*. The rules governing the use of their weapons and their construction are beyond the Standard Rules presented in *Total Warfare* and *TechManual*. They are covered in the Advanced Rules presented in *Classic BattleTech Tactical Operations*.

The Battle Value (BV) system provides a numerical rating (a "point system") that represents the damage capabilities and survival potential of every *BattleTech* unit. The Battle Value system can be used by players to aid in the creation of their own balanced scenarios. All Battle Values listed in this book were generated using the Battle Value system as it appears in *TechManual*. If a unit lists a NA under Battle Value, then it falls into the Advanced Rules category, as described above.

Pre-Filled Record Sheets

As detailed under *Record Sheets*, page 9, of the *Classic BattleTech Introductory Rulebook* of the *Classic BattleTech Introductory Box Set*, players can go to www.battlecorps.com/catalog and purchase pre-filled Record Sheet book PDFs such as *Record Sheets: 3039*. Such PDFs enable a player to easily print out pre-filled record sheets as needed, for ease of use.

Record Sheets: Project Phoenix Upgrade contains pre-filled record sheets (i.e. all the necessary game play stats) for the 'Mechs detailed in the *Project Phoenix* section of this product. Furthermore, many additional variant record sheets of those 'Mechs found within *Record Sheets: Project Phoenix Upgrade* are fully covered within *Technical Readout: Project Phoenix*. As noted above concerning some of the variants found within this product, those *Technical Readout: Project Phoenix* variants mount weaponry found in *Total Warfare* and will require that rulebook to use.

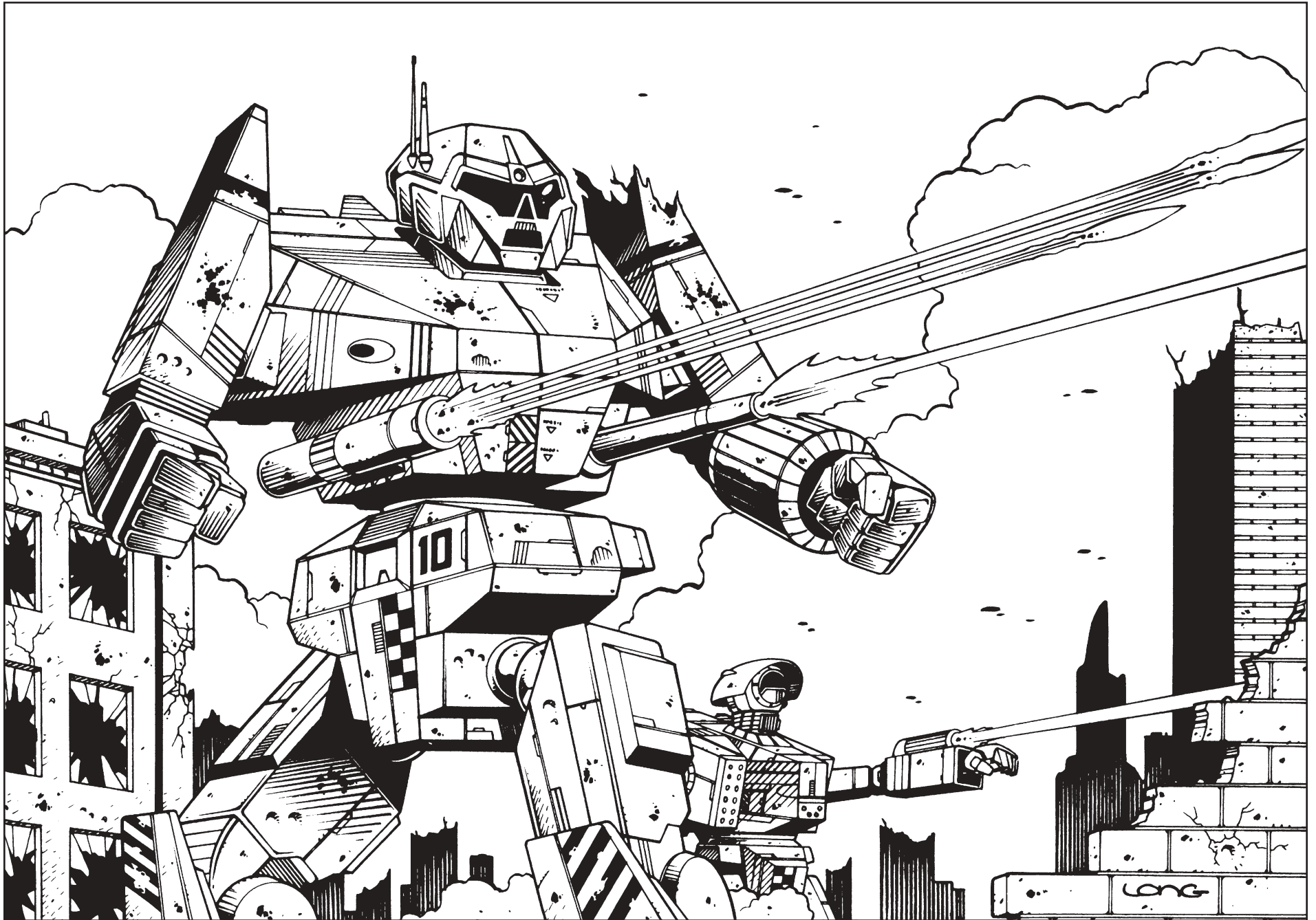

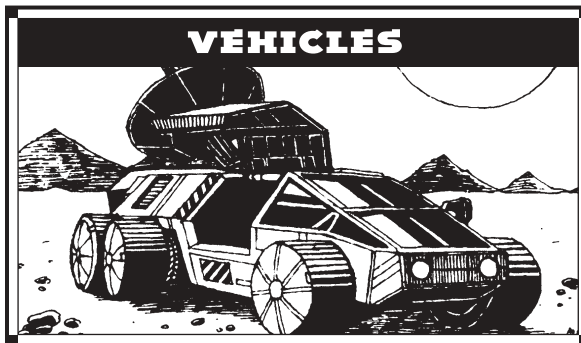

Once considered “Kings of the Battlefield” centuries before any modern BattleMech was a gleam in a designer’s eye, conventional combat vehicles have endured the test of time. Since the early twentieth century, when the first tank rolled across barbed wire and trenches at an astounding three kilometers per hour before breaking down due to mechanical failure, tanks and their various cousins have played an irrefutably important part in any given battle or campaign.

With the advent of the BattleMech, however, conventional combat vehicles were thought to finally have an appropriate successor. BattleMechs were more durable, could traverse any terrain a vehicle could and even terrain most vehicles could not, and could be deployed quickly via orbital insertions, something vehicles had attempted to do only a few times with disastrous results. The Star League invested massive amounts of funds into BattleMech research and development, much to the chagrin of the generals in charge of combat vehicle brigades. Attempts to produce conventional vehicles just as effective as ‘Mechs had mediocre results, as many pointed out that in an intense fight, the BattleMech unit would overcome a conventional vehicle force almost every time.

It was this intense fighting, ironically, that led to the resurgence of conventional vehicles. The Succession Wars devastated the Inner Sphere’s manufacturing and technological base, slowing down (or in many cases stopping) production of the advanced and expensive fighting machines. Conventional vehicles were less expensive, and unlike BattleMech production, those production lines could often be repaired and even built from scratch on a variety of worlds. Depending on the design, a conventional tank could be purchased three or four times over for the same price as an equally sized BattleMech, and with ‘Mechs now held in reserve for only important operations, planetary militias and defense forces found themselves with no other option but to fill their ranks with armored fighting vehicles, using swifter hover-skirt and wheeled units to scout for ambushes and enemy advances. Their smaller size would prevent detection, allowing them to on occasion ambush and destroy a “superior” BattleMech force.

House Davion was the first to officially recognize the full potential of conventional combat vehicles. While others used them in defensive operations only or created ad-hoc brigades for offensive operations, the AFFS created official brigades that mixed BattleMechs and conventional vehicles together. Thanks to the combined efforts of Houses Davion and Steiner, conventional vehicles played a much more important and recognized role in the Fourth Succession War and the War of 3039, performing duties many once thought could only be done effectively by BattleMechs. Even mercenary commands such as the notable Gray Death Legion and Hansen’s Roughriders have been recognized over the decades as effectively using their conventional assets in campaigns, while other exceptional units such as The Furies and Mobile Fire use combat vehicles as their primary combat force.

Many various combat vehicle designs exist, filling niches such as infantry transport, scouting, fire support, as well as the more traditional roles such as installation defense, picket, and frontline combat duties. Combat vehicles have a wide variety of motive systems available, from the more common tracked, wheeled, and the fragile hover skirt, to the rotary and vector thrust Vertical Take-Off and Landing (VTOL) craft and even the oddball wet-navy designs that patrol important water-rich planets. For every BattleMech design in existence, there is a conventional vehicle that attempts to do the same duty at half cost or less.

Just as they were centuries ago, these vehicles have proven that, despite not having the glamorous reputation they once did, they are still indispensable.

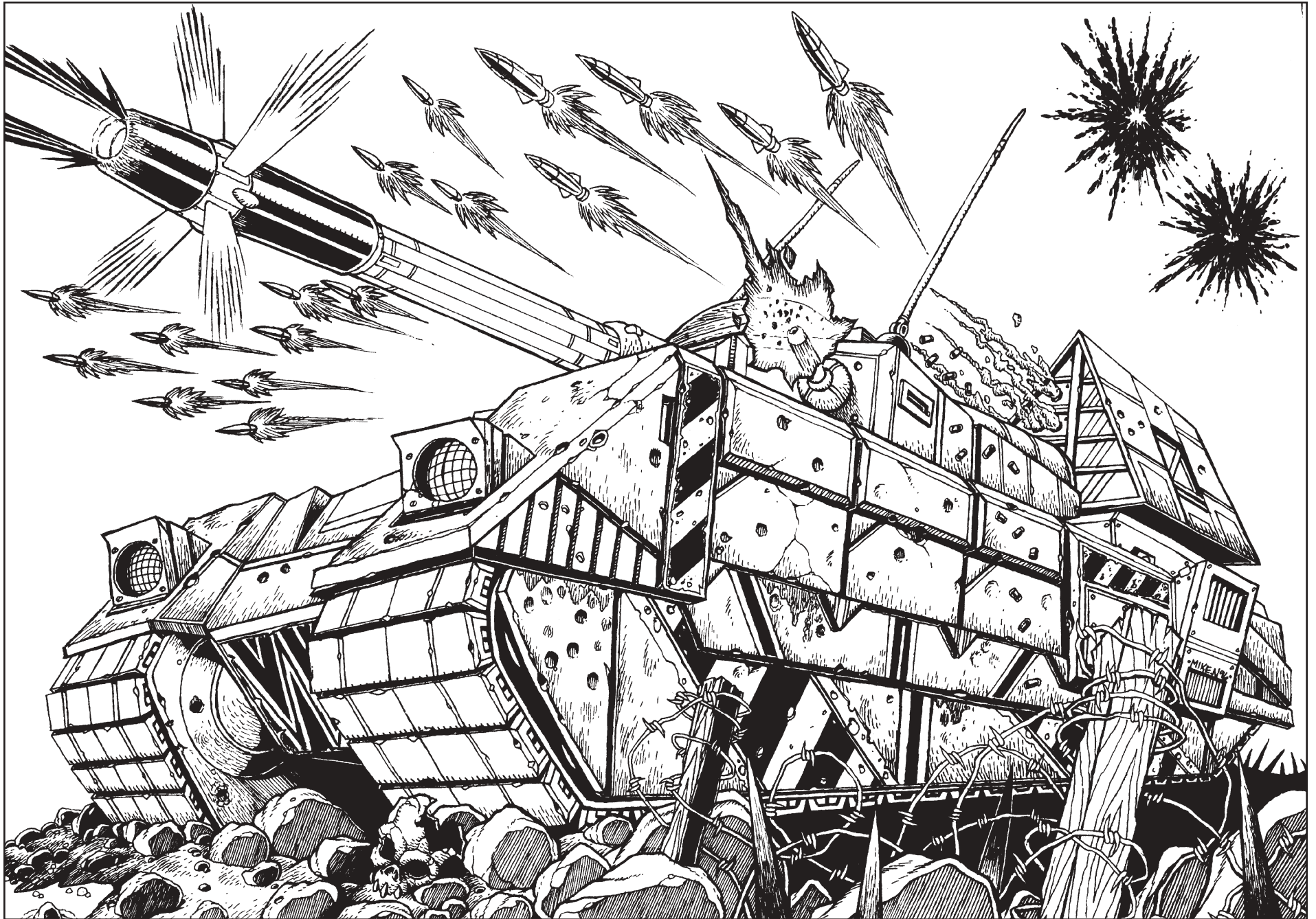

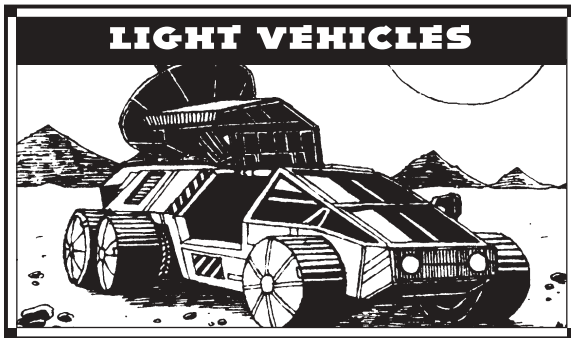

Mass: 5 tons

Movement Type: VTOL

Power Plant: Tyron 25 ICE

Cruising Speed: 162 kph

Flank Speed: 248 kph

Armor: ProtecTech Light

Armament:

1 MainFire Minigun Machine Gun

Manufacturer: Cal-Boeing of Dorwinion

Primary Factory: Belladonna

Communications System: Achernar Standard

Targeting and Tracking System: IsBM Lantirn

Overview

The Ferret Light Scout VTOL is a Federated Suns reconnaissance rotor craft introduced in 2904. Although the Ferret's organic offensive capabilities are almost nonexistent, it can call in long-range artillery fire and maintain contact with the enemy until a more suitable attack force moves into the area. It serves very well on screening operations, but the Ferret's speed and troop-carrying ability make it effective in all manner of exercises, including counterinsurgency operations, reconnaissance missions, rear-area insertions and extractions, battlefield pilot recovery, infantry squad transport, and spotting.

Capabilities

The Ferret's limited armor protection is its prime disadvantage. This vulnerability is not considered critical, however, because the Ferret's mission is to avoid combat. A Ferret is designed to stay well outside the effective range of any hostile unit while keeping the target under observation. For that reason, the Ferret's design keeps offensive armament to a minimum.

Another interesting feature is the Ferret's IsBM Lantirn targeting and tracking system. In addition to its normal targeting capabilities, the Heads-Up Display IsBM can also plug into any standard remote sensor monitoring set.

Deployment

The Ferret has also entered service with Steiner, Marik, and some worlds of the Periphery. When House Kurita attacked Tamar in 2915, Colonel Richard Gunston ordered a company of infantry from his Fifty-fourth Combined Arms Combat Team to use their attached Ferrets to make an airborne assault on the Fourth Proserpina Hussars landing zone. The slaughter was tremendous. The Kuritans blasted the six Ferrets out of the sky, and the Fifty-fourth broke and ran.

Five months later, the Fifty-fourth once again faced the Hussars on Tamar. The Kurita force attempted a flanking maneuver to encircle the capital, Tamar City. The Fifty-fourth's new commander, Hauptmann-Kommandant Jennifer Miller (who replaced Colonel Gunston when he was killed the month before), knew she would have to make a stand in the Remanny Hills to prevent this. Instead of meeting the Hussars head on, she ordered her Ferrets and a company of infantry to raid the Kurita rear areas, making it clear that the Ferrets were not to engage directly in combat. Their mission was to locate convoys, supply dumps, and maintenance points, and then ferry the infantry in to attack these targets. The Ferrets and infantry did their job superbly. They scattered remote sensors all along roads and trails, then lifted the infantry into ambush positions after spotting vulnerable targets. In this way the infantry was able to destroy several maintenance units and re-arming points.

Believing that a battalion of commandos was operating in their rear area, the Fortieth slowed its advance

and detached a battalion of light 'Mechs for rear-area security, meaning they lacked the strength to complete the encirclement.

Two months later, the Kurita forces were forced off Tamar.

Variants

Cal-Boeing has introduced two variants of the Ferret. The first eliminates the craft's troop-carrying capacity in favor of increased armor, thus making the Ferret a more robust vehicle. Introduced in 2967, this "Wild Weasel" variant was Cal-Boeing's attempt to create a combat version. The second does the opposite, stripping all the armor and weaponry to make the Ferret a light cargo transport with a capacity of two-and-a-half tons.

Notable Crews

Corporal Hatashi Williams: Corporal Hatashi Williams pilots the Ferret called "DragonFly." While assigned to troops guarding the New Avalon Institute of Science, he got into a rather loud argument with another student regarding the Ferret's maneuverability. Seeking to give the student a practical demonstration, Hatashi finished off the last of his drink, grabbed the offending student by the scruff of the neck, and proceeded down to the airfield. Strapping himself and his unwilling passenger into the tiny craft, Hatashi proceeded to demonstrate the full capabilities of a rotor wing aircraft. While flying over, between, and under some of the Institute buildings, Hatashi calmly delivered a lecture on combat flying. Needless to say, the student was greatly impressed, but the Institute authorities were not. One court-martial later, Hatashi and DragonFly were reassigned to a combat unit.

In mid-3039 the Fortieth Dieron Regulars attacked Quentin. Hatashi and DragonFly remained busy ferrying troops around the Steel Valley region. When the Independence Weaponry plant fell to the Kurita forces, Hatashi's skill was called on to run the gauntlet of Combine air cover several times to evacuate top Independence executives and technicians.

Hatashi and DragonFly were on the last Davion DropShip to boost from Quentin.

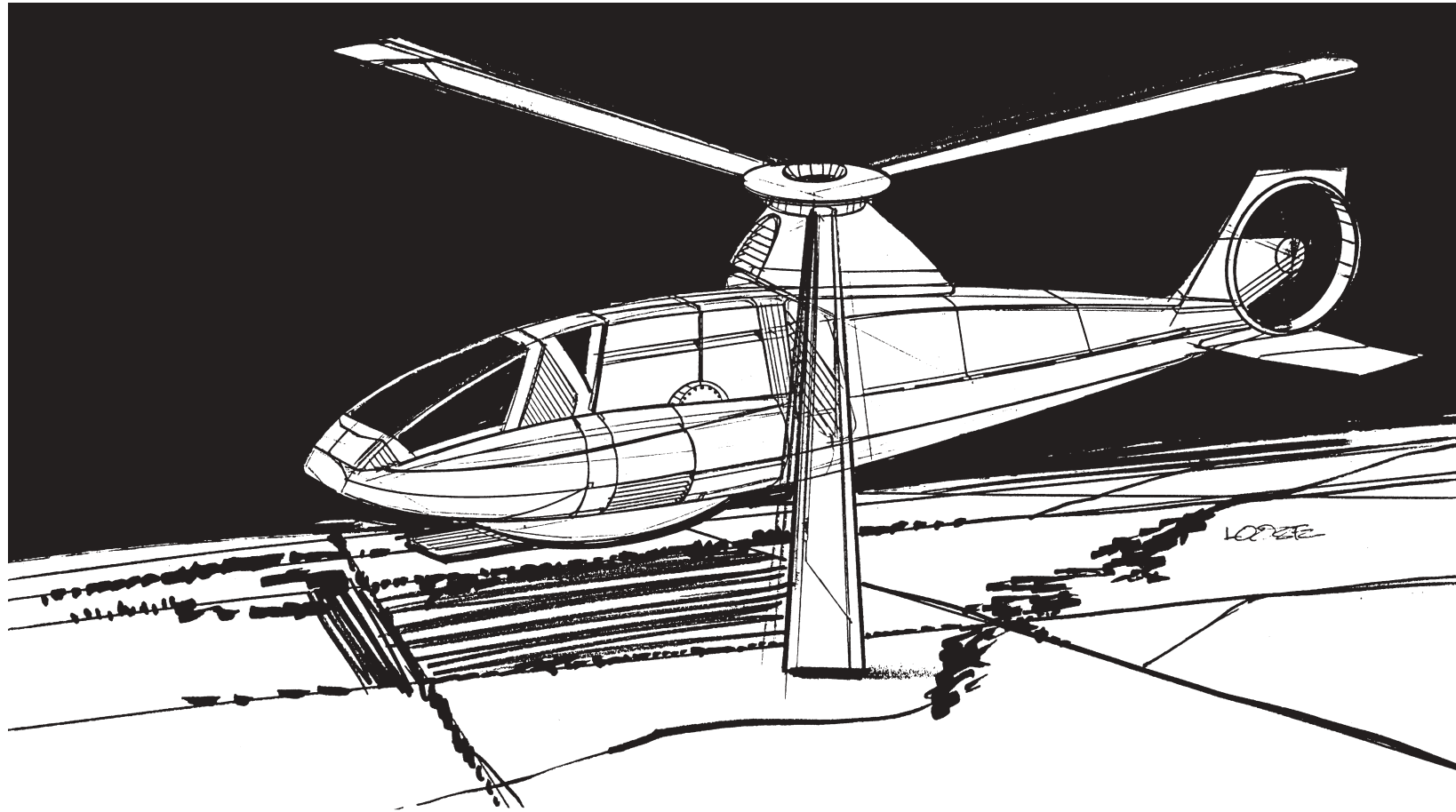

Type: **Ferret Light Scout VTOL**
 Technology Base: Inner Sphere
 Movement Type: VTOL
 Tonnage: 5
 Battle Value: 55

Equipment	Mass
Internal Structure:	.5
Engine:	1
Type:	ICE
Cruising MP:	15
Flank MP:	23
Heat Sinks:	0
Control Equipment:	.5
Rotor:	.5

Equipment	Mass
Power Amplifier:	0
Turret:	0
Armor Factor:	8
	<i>Armor Value</i>
Front	2
R/L Side	1/1
Rear	2
Rotor	2

Weapons and Ammo	Location	Tonnage
Machine Gun	Front	.5
Ammo (MG) 100	Body	.5
Infantry Bay	Body	1

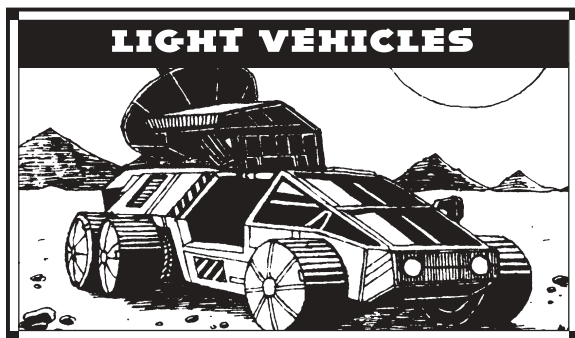

Mass: 5 tons
Movement Type: Hover
Power Plant: Edasich Omni 25 Fusion
Cruising Speed: 140 kph
Flank Speed: 216 kph
Armor: Durallex Light
Armament:
1 Defiance B3M Medium Laser
Manufacturer: S.L. Lewis, Inc.
Primary Factory: Carlisle
Communications System: TharHes Hm 10
Targeting and Tracking System: TharHes Alpha-2a

Overview

First conceived out of the bounty from a recovered Star League storage facility, the Savannah Master hovercraft has become the preeminent cavalry and pursuit vehicle of almost every Lyran regiment. In a military known for the preponderance of massive and slow-moving BattleMechs, the nimble Savannah Master's incredible speed is often overshadowed.

S.L. Lewis, an officer on the JumpShip *Winnetka*, claimed more than 2,000 25-rated Omni fusion engines—rumored to be the most efficient ever designed—as his share of the bounty and used them to help build the Savannah Master. After a legendary procurement exercise against a *Locust*, the LCAF ordered more than a thousand of the nimble craft, and the AFFS soon followed suit.

Capabilities

The heart of the Savannah Master's appeal is its phenomenal ground speed—more than 200 kilometers per hour at flank speed—coupled with its extreme simplicity of design. Lewis, when designing it, ensured that it would be easily maintained and repaired, using commonly-available components. The vehicle's electronics are manufactured on the Lyran capital Tharkad, while the hovercraft's sole weapon is the readily available Defiance B3M Medium Laser.

Although 2,000 engines seemed like enough, the devastation of the Fourth Succession War quickly showed Lewis two things: that the demand for the Savannah Master would only increase as reports of its value in combat emerged, and that he would quickly need a substitute for the Omni if he was going to continue to produce his flagship creation.

In late 3035 Lewis offered the last ten Omni 25s to any Lyran fusion engine producer willing to reverse-engineer its secrets. By 3037 Edasich Motors had succeeded in getting the Omni into standard production, and the assembly lines at S.L. Lewis, Incorporated were retooled to accept the Edasich Omni 25. The original Lyran order for 1,000 Savannah Masters has been repeated every decade, and the merger of the LCAF with the Armed Forces of the Federated Suns doubled the annual invoice. After the Civil War, S.L. Lewis, Inc. continued to support service contracts in the Federated Suns but has not made any new sales to the AFFS.

Deployment

The Savannah Master's first combat action was its now-famous procurement exercise, where Lewis himself piloted the vehicle against MechWarrior Savannah Johnson. After repeatedly being defeated in simulation, Johnson overrode her controls and brought her full weapons to bear, turning the exercise into a grudge match. Lewis responded in kind, eventually bringing the *Locust* down by touching off its ammunition. In recent years some have begun spreading the rumor that the story must have been staged; LCAF training regulations prohibit carrying live ammunition in a

training exercise, but Lewis has always responded to these rumors with replies containing considerably more style than substance.

The craft's combat reputation was cemented during the Fourth Succession War, however. In almost every instance of its use, the Savannah Master accomplished its mission objectives with little or no difficulty. Many attribute its successes to the AFFS advisors present in many Lyran cavalry units; for too long the average Steiner commander's orders would have been simply "charge!" Many Savannah Master units came to excel at the tactic of the lightning raid, and small units of them were used to spring behind enemy lines to destroy targets of opportunity. McCarron's Armored Cavalry acquired a shipment of the small vehicles and also made good use of them against the AFFS during the Fourth Succession War.

Variants

The basic simplicity of the Savannah Master does not lend itself to a plethora of design alternatives, and so variations on the S.L. Lewis, Inc. chassis are rare. A test-bed version mounting a pair of light lasers in place of the Defiance B3M was tested in 3033 but quickly discarded once it was determined that even the Savannah Master's supreme speed advantage was not enough to overcome the light lasers' lack of range.

Notable Crews

Sergeant Richard Goodman: Sergeant Goodman leads an independent company of scout hovercraft attached to the cavalry battalion of Halsten's Brigade, a mercenary armored brigade in the service of House Steiner. While the lion's share of media attention is paid to the heavier tanks (and media darling "Sniper" Jones and his Schrek), Goodman's Savannah Masters are often found leading Halsten's flanks, sniping and searching for any advantage. While Colonel Halsten is adamant that it's his heavy armor that smashes its way through the enemy—conventional or BattleMech—he has been known to admit that his "scooters," as he calls them, are key to finding his panzer's victims.

SAVANNAH MASTER HOVERCRAFT

Type: Savannah Master Hovercraft

Technology Base: Inner Sphere

Movement Type: Hover

Tonnage: 5

Battle Value: 215

Weapons and Ammo

Medium Laser

Location

Front

Tonnage

1

Equipment

Internal Structure:

Engine:

Type:

Cruising MP:

Flank MP:

Heat Sinks:

Control Equipment:

Lift Equipment:

Power Amplifier:

Turret:

Armor Factor:

Mass

.5

1

Fusion

13

20

10

0

.5

.5

0

0

1.5

*Armor
Value*

Front

R/L Side

Rear

10

6/6

2

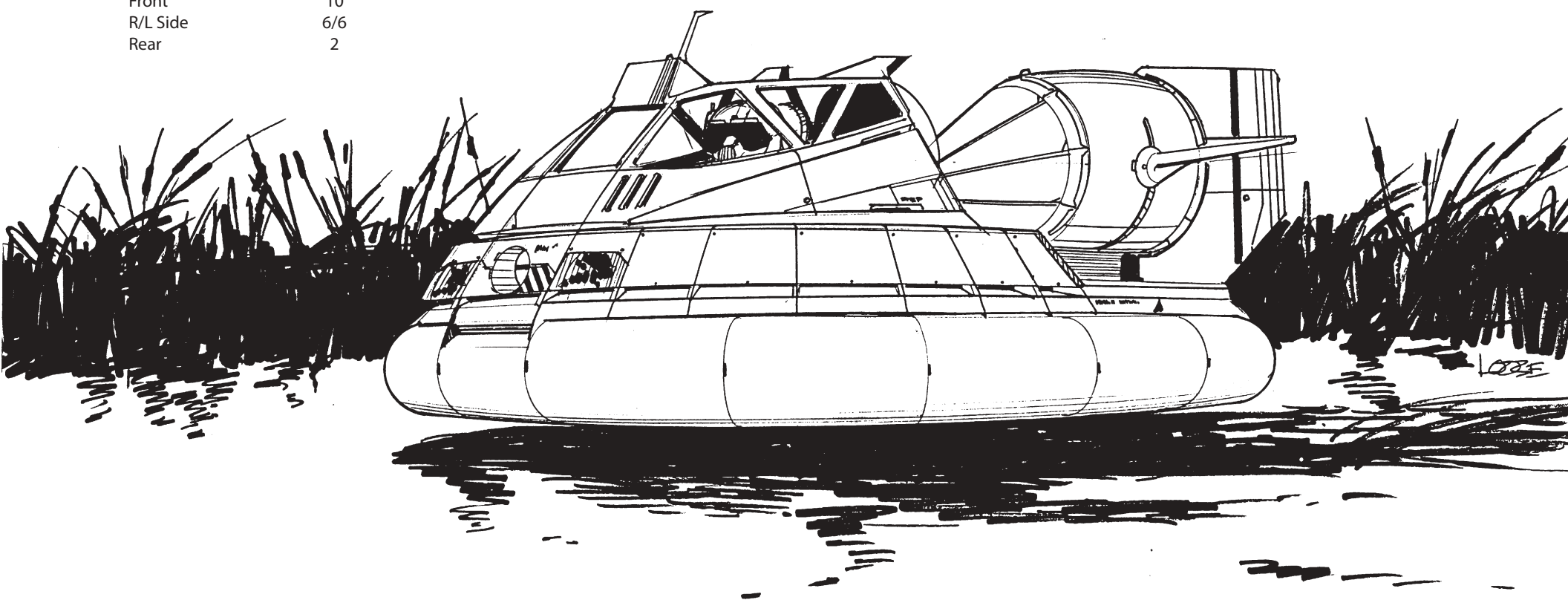

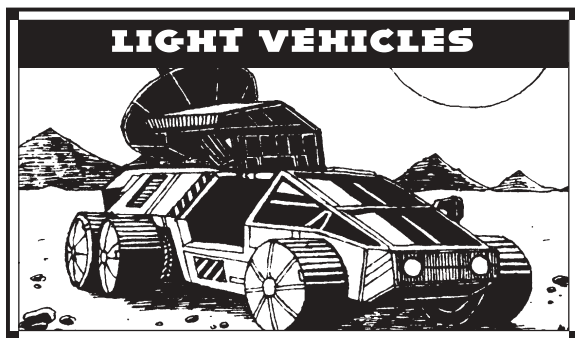

Mass: 8 tons

Movement Type: Wheeled

Power Plant: GM 60 Fusion

Cruising Speed: 108 kph

Flank Speed: 162 kph

Armor: StarSlab/1

Armament:

None

Manufacturer: Ceres Metals

Primary Factory: Indicass

Communications System: CeresCom Recon Model 12k

Targeting and Tracking System: I-Bal Mark 3

Overview

Since the automobile replaced the horse as the primary means of personal transportation, the scout car has been serving militaries everywhere. The Swift Wind is another iteration in this long line of vehicles. Ceres Metals' proposed scout car blew away competing bids for a recon vehicle to serve the Capellan Military. Where other manufacturers submitted designs that were inexpensive, Ceres went for state-of-the-art technology. As the components of the Swift Wind have advanced, Ceres has kept pace, but the overall design has changed little.

Capabilities

Six Tablar-lined radial tires provide durable locomotion over a variety of terrains, from rough to smooth roads. As long as three tires are operational, the Swift Wind can live up to its name and maintain a top speed of over 160 kph. This velocity can often tax the most experienced of drivers, so Swift Winds are equipped with a scaled-down neurohelmet, allowing minor changes based on the pilot's sense of balance. With speed like that, the Swift Wind can escape almost any land-bound opponent. A ton and a half of StarSlab/1 armor allows it to shrug off moderate firepower while fleeing to friendlier areas.

While lacking a traditional weapon, commanders often find that the two tons of advanced communication equipment in the Swift Wind is more powerful than a Buster autocannon. Enemy units caught in an artillery barrage called in from a Swift Wind can testify to the scout car's capability. Powerful enough to transmit coherent data and messages as far out as JumpShips at standard jump points, the Swift Wind can keep in contact from deep in enemy territory. On planets with a functional satellite system, the Swift Wind can stay in touch with units on the other side of the planet.

Deployment

Only a few dozen Swift Winds can be found outside the Capellan Confederation (or the short-lived St. Ives Compact), with most of those "foreign" Swift Winds operated by mercenary units that served House Liao well. With the secession of St. Ives, Swift Winds actually competed against one another as the Confederation mounts raids against its former state. On Milos, the Compact used Swift Winds to keep tabs on Capellan scout units, tracking the signals to the main body of troops. House Liao troops quickly caught on, and it became a dangerous game of hide and seek. Swift Winds would call in combat units on enemy Swift Winds who in turn would call in their own support while both units tried to elude the combat troops. Outside the town of Peking, two Swift Winds finally took the fight into their own hands, turning a wheat field into a demolition derby arena.

Variants

The Swift Wind is a modern scout vehicle with a modern price tag. For customers on a tighter budget, Ceres has a version with a Confederated Motors 60 Ethanol/Flex. This internal combustion engine is a very reliable power plant but eliminates the standard cargo capacity. Some older Swift Winds use lighter ICE engines that provide cargo at the expense of speed, while others use larger engines that necessitate removal of some of the armor.

Notable Crews

Scout Mick Lewis: A pilot of a rare non-Capellan Swift Wind, Mick provides the First Brigade of the Fusiliers of Oriente with the best recon reports in the League. Lewis is so quiet and stealthy that he stole his Swift Wind out from under the nose of its Capellan driver. That success has not dampened his aggressive nature. He will actually sneak into enemy camps and get detailed information on supplies from ammunition to fuel to sundries. This had allowed the Fusiliers not only to determine the size of the opposing force but also the type and duration of the mission. Officers can often recognize Mick's report even with his name redacted due to the thoroughness of his efforts.

Saint Ivan: No one knows the pilot's real name, but he drives a specialized Swift Wind that roams the more remote Capellan planets, broadcasting the Free Capella Network. Citizens and non-citizens alike can be found gathering around radio, video, and trideo receivers when Saint Ivan is in the vicinity, hoping for a glimpse of the better life and perhaps what they can do to help achieve it. The Maskirovka attempts to crack down on people listening to the FCN as well as hunting down Saint Ivan, but the closest they have come was a brief glimpse on Holloway. The bounty on Saint Ivan is now at over three million L-Bills.

SWIFT WIND SCOUT CAR

Type: **Swift Wind Scout Car**

Technology Base: Inner Sphere

Movement Type: Wheeled

Tonnage: 8

Battle Value: N/A

Equipment

		Mass
Internal Structure:		1
Engine:	60	2.5
Type:	Fusion	
Cruising MP:	10	
Flank MP:	15	
Heat Sinks:	10	0
Control Equipment:		.5
Lift Equipment:		0
Power Amplifier:		0
Turret:		0
Armor Factor:	24	1.5
	<i>Armor Value</i>	
Front	6	
R/L Side	6/6	
Rear	6	

Weapons and Ammo

	Location	Tonnage
Communications Equipment	Body	2
Cargo	Body	.5

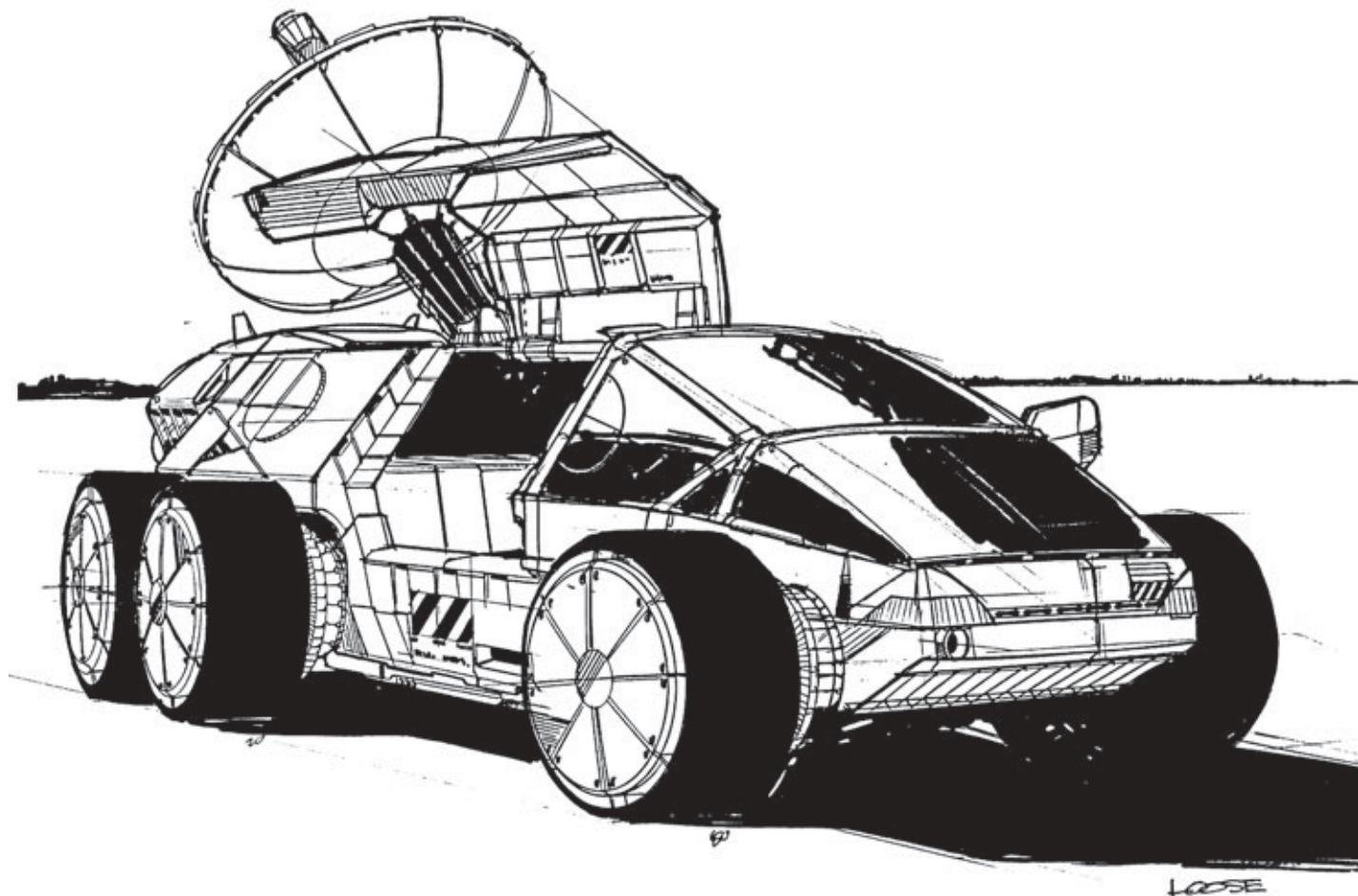

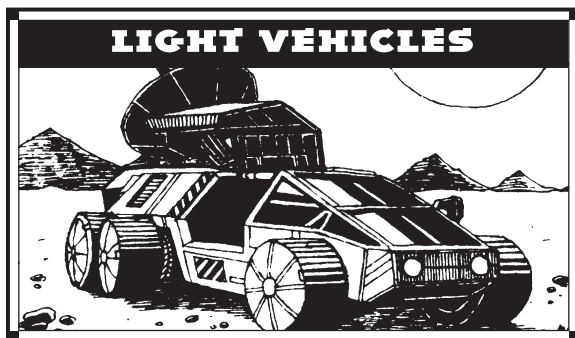

Mass: 10 tons

Movement Type: Tracked, Hover, Wheeled

Power Plant: 60 (Tracked, Hover) or 40 (Wheeled)

ICE, various manufacturers

Cruising Speed: 64 kph (Tracked, Wheeled)

or 108 kph (Hover)

Flank Speed: 97 kph (Tracked, Wheeled)

or 162 kph (Hover)

Armor: Various

Armament:

2 Machine Guns, various manufacturers
(Hover, Wheeled)

1 Machine Gun, various manufacturers (Tracked)

Manufacturer: Various

Primary Factory: Various

Communications System: LongCom

Targeting and Tracking System: OptiTrack Techniques

Overview

Infantry is the backbone of any military. Aerospace fighters may dominate the sky and BattleMechs may mount more firepower than any other weapons platform in history, but for taking an objective, holding territory, rescuing fallen comrades, making precision strikes, providing relief for noncombatant refugees, or any of the hundreds of jobs a campaign requires, nothing compares to the efficiency and effectiveness of ground pounders. Though undervalued by neophyte cadets and armchair generals far from the front lines, every working military knows defeat or victory can depend on how well their infantry rises to the

occasion. And infantry's impact depends on their ability to get where they need to be when they need to be there.

Armored personnel carriers are the vehicles charged with getting the troops in and out of the combat zone. The three basic designs currently in use date from the Star League and have been in continuous production, virtually unchanged, for centuries.

Capabilities

The most robust and dependable APCs rely on tracks to carry them across any terrain. Though they mount only half the firepower of their wheel and hover cousins, tracked APCs are the vehicle of choice when battle is being joined on unfamiliar ground. Wheeled APCs require more predictable terrain, but within that limitation are more maneuverable. They are the APC of choice in urban or industrial combat. Hover APCs are much faster than the others, ideal for quick insertions, extractions, or moving troops rapidly over great distances. However, they require nearly flat land or water on which to maneuver. A wall that a tracked APC would roll right over, for example, must be physically removed by a hover APC's passengers.

Deployment

Every military in the Inner Sphere employs each type of APC. Utilization of infantry varies from House to House, though, and thus APCs may only be found in second-line garrison duties in the Draconis Combine, but they serve in frontline units with House Steiner.

Variants

The ubiquitous vehicles are found in many factory variants and are frequently modified by individual units in the field. Some militaries—notably planetary militias lacking in financial resources—convert them into weapons platforms to support deployed ground troops with varying degrees of success. The simplest method replaces the personnel weight allotment with additional machine guns and ammo, but other variants are more extensive. Small SRM or LRM launchers are known to be used in APCs, as are documented instances of hover APCs equipped with advanced sensors and used as scouts by the Taurian Concordant and the Marian Hegemony. Though mounting

improved sensors on such a fast, light vehicle makes some sense, in the minds of most tacticians the APC's inability to defend itself presents an unacceptable risk of losing a hard-to-replace sensor array.

Infantrymen are sometimes considered the craziest of all combat troops. To enhance this image and strike fear into their opponents, they often paint their carriers in bright, garish colors that clearly reveal their position to anyone within sighting distance.

Notable Crews

Överste-Löjtnant Illya Stroncek: The KungsArmé had hardly been formed when the battered remnant of a *ronin* Draconis Combine regiment fleeing the heavy fighting on Jezersko took refuge on Last Frontier in late 3034. The Last Frontier Infantry—essentially the planet's former freedom fighters in new uniforms—could do little to stop the renegade force and sensibly dug in to wait for reinforcements. The regular DCMS force that answered was in even worse shape than the Ronin troops. *Tai-sa* Bruce Morganstern ordered the local infantry to provide logistical support for the beleaguered force as they sought to contain and destroy the outlaws.

The fighting was savage, with neither Draconis force caring what collateral damage they did in their efforts to eradicate the other. On the evening of 14 November 3034, two BattleMech companies clashed in the foothills of the Belville Mountains. *Överste-Löjtnant* Illya Stroncek of the Last Frontier Infantry warned both the DCMS and *ronin* forces that Navassa, a farming community of some two thousand souls, was in the center of the proposed battlefield. The Draconis commanders, however, refused to break off the engagement, and Stroncek ordered his APCs to evacuate Navassa. Though no BattleMech specifically targeted an APC, neither did they pause as the vehicles rushed back and forth beneath the guns. The last *ronin* BattleMech on Last Frontier fell in the predawn hours of 15 November. Only charred earth marked where the hamlet of Navassa had stood, but thanks to the Last Frontier Infantry's brave rescue under fire, not a single civilian life was lost.

ARMORED PERSONNEL CARRIERS

Type: **APC (Tracked)**

Technology Base: Inner Sphere

Movement Type: Tracked

Tonnage: 10

Battle Value: 142

Weapons and Ammo

Machine Gun

Ammo (MG) 200

Cargo (Infantry)

Location

Turret

Body

Body

Tonnage

.5

1

1

Equipment

Internal Structure:

Engine:

Type:

Cruising MP:

Flank MP:

Heat Sinks:

Control Equipment:

Lift Equipment:

Power Amplifier:

Turret:

Armor Factor:

Mass

1

3

ICE

6

9

0

.5

0

0

.5

2.5

Armor Value

Front

R/L Side

Rear

Turret

10

8/8

10

4

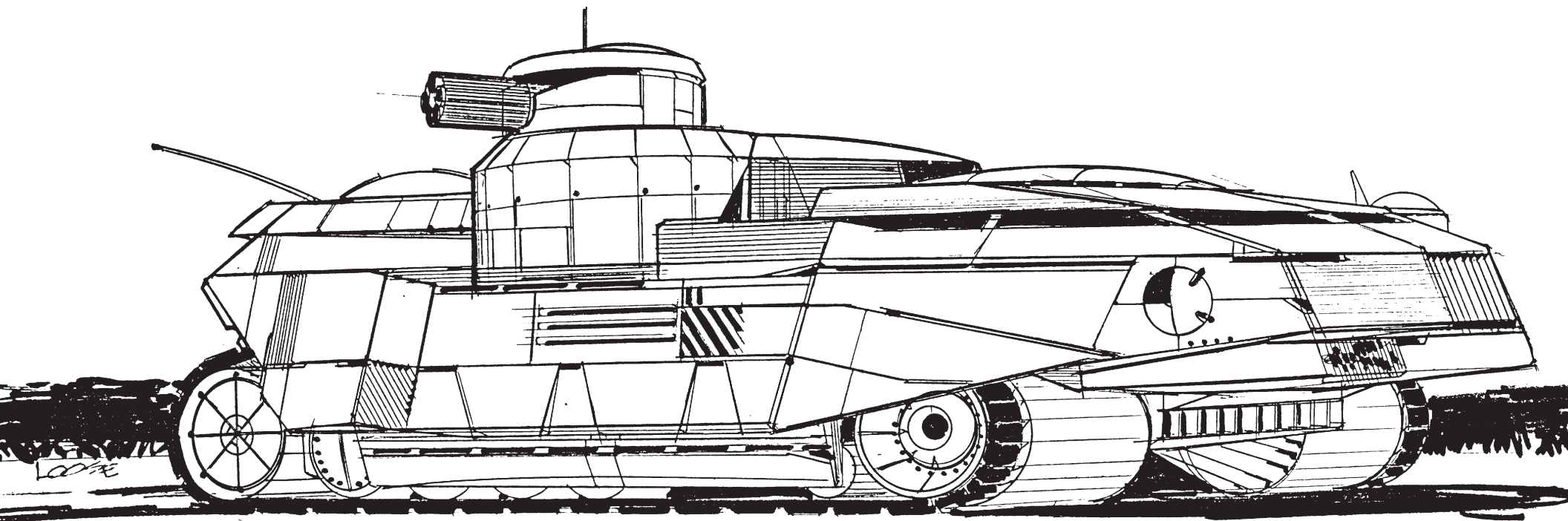

ARMORED PERSONNEL CARRIERS

Type: **APC (Hover)**

Technology Base: Inner Sphere

Movement Type: Hover

Tonnage: 10

Battle Value: 102

Equipment

Turret:

Armor Factor:

24

Armor

Value

Front

5

R/L Side

5/5

Rear

4

Turret

5

Mass

.5

1.5

Equipment

Internal Structure:

Mass

1

Engine:

60

3

Type:

ICE

Cruising MP:

10

Flank MP:

15

Heat Sinks:

0

0

Control Equipment:

.5

Lift Equipment:

1

Power Amplifier:

0

Weapons and Ammo

2 Machine Guns

Location

Turret

Tonnage

1

Ammo (MG) 100

Body

.5

Cargo (Infantry)

Body

1

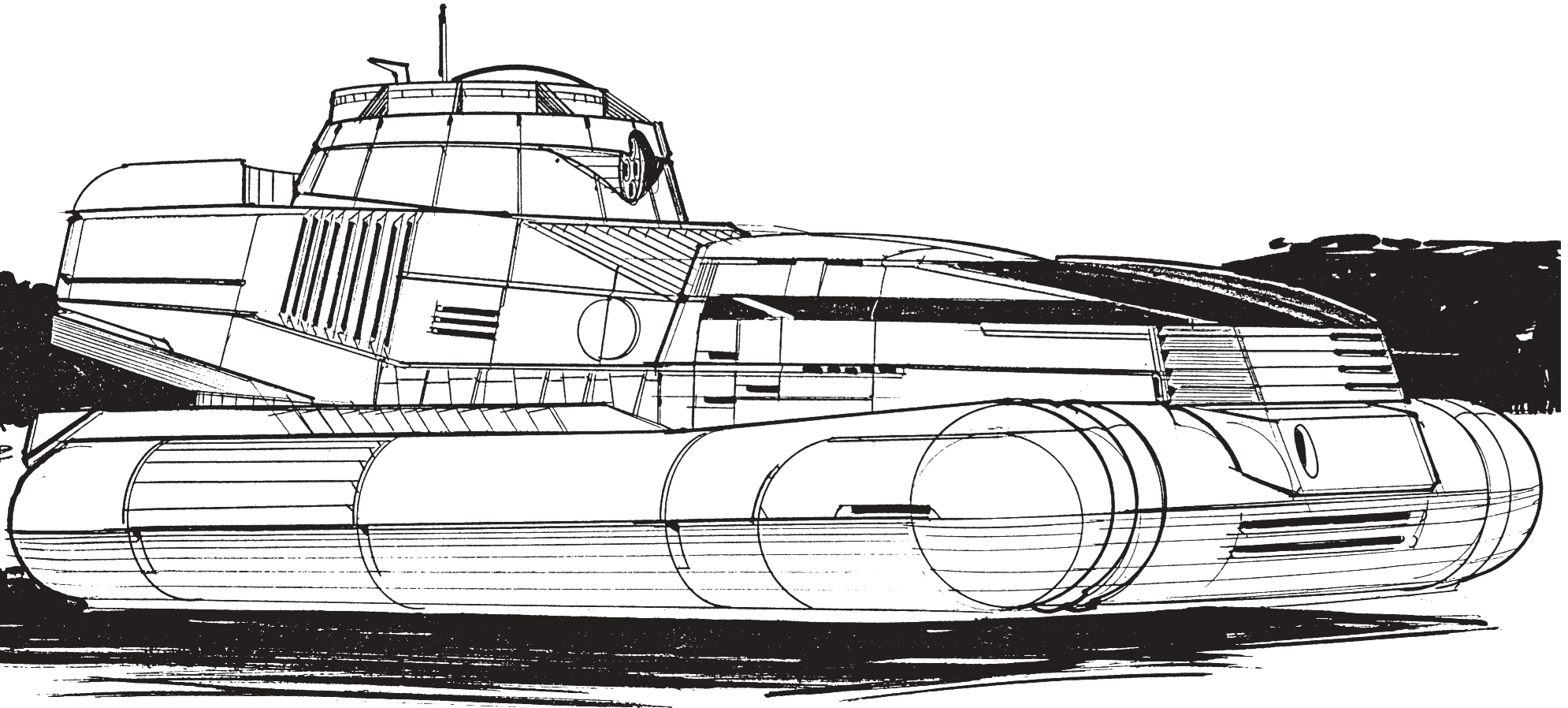

ARMORED PERSONNEL CARRIERS

Type: **APC (Wheeled)**

Technology Base: Inner Sphere

Movement Type: Wheeled

Tonnage: 10

Battle Value: 157

Equipment

		Mass
Internal Structure:		1
Engine:	40	2
Type:	ICE	
Cruising MP:	6	
Flank MP:	9	
Heat Sinks:	0	0
Control Equipment:		.5
Lift Equipment:		0
Power Amplifier:		0

Equipment

		Mass
Turret:		.5
Armor Factor:	48	3
	<i>Armor Value</i>	
Front	12	
R/L Side	10/10	
Rear	10	
Turret	6	

Weapons and Ammo

	Location	Tonnage
2 Machine Guns	Turret	1
Ammo (MG) 200	Body	1
Cargo (Infantry)	Body	1

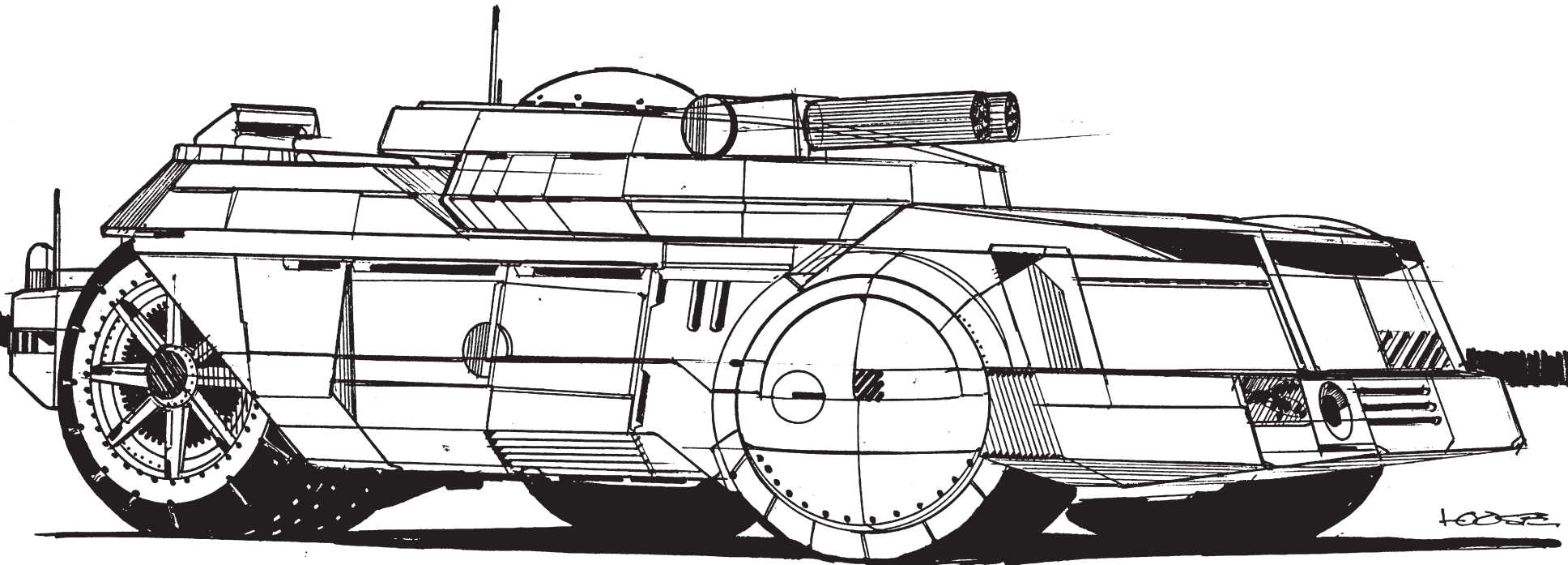

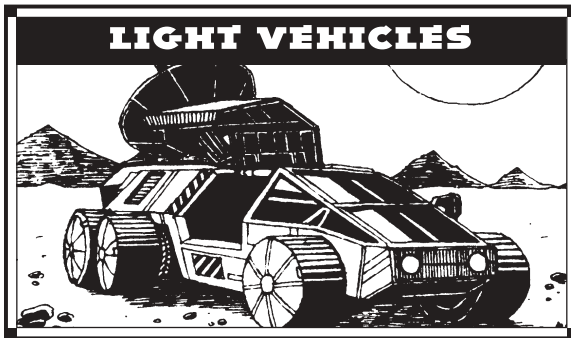

Mass: 10 tons

Movement Type: Tracked

Power Plant: 50 ICE (various)

Cruising Speed: 54 kph

Flank Speed: 86 kph

Armor: StarSlab/1

Armament:

1 SperryBrowning Machine Gun

Manufacturer: Acme Widgets, Various

Primary Factory: Zollikofen (discontinued 2763),
Various

Communications System: Tandy A-100

Targeting and Tracking System: None

Overview

The J-27, which has yet to illicit a flattering (or even printable) nickname, is one of the backbones of large-formation warfare. Primarily used to transport ammunition from secure areas or spaceports to forward bases in secure rear areas, the J-27 is built to withstand attacks from criminals or guerrilla infantry, not frontline units. The Star League used the J-27 as its primary munitions transport unit, purchasing tens of thousands from Acme.

Capabilities

Between the tractor and trailer, the J-27 can transport eleven tons of munitions, enough to resupply a

typical lance of 'Mechs. A half-ton of armor protects the unit from small-arms fire and the weakest battlefield weapons. The fact that the trailer has twice as much armor does not win any compliments from J-27 crews. The engine allows the unit to reach 86 kph, though most forces have installed governors to keep the speed to a safe cruising speed of around 50 kph. Special authorization from a commander is needed to deactivate these governors.

Crews of the J-27 tend to be the dregs of infantry. The Draconis Combine in particular is noted for using criminals in penal units to man the transport. Given the choice between a death sentence and J-27 duty, many choose the death sentence. At first this claim was dismissed as hyperbole, but studies have shown it to be true. Ordnance transport is grueling work, and the crews are nearly always on edge, with stress levels causing a myriad of illnesses. Illness won't get a criminal out of duty, and the mortality rate for J-27 crews is over triple that of any other military vehicle.

In a nod to self-defense, the transport is equipped with a turret-mounted machine gun. Some critics suggest adding a second machine gun in exchange for reduced ammo. This would add little to the J-27's survivability, as crews tend to be very aggressive in using the gun. The second gun (or the first) would not help against most military vehicles, but extra ammunition can be used to keep enemy infantry behind cover longer while the vehicle retreats. Frontline units may also scavenge the J-27's machine gun ammo, a practice that J-27 owners (not J-27 crews) consider useful enough to maintain the ammo bin at a full ton rather than sacrificing any for a second machine gun.

Deployment

The J-27 can be found everywhere in the Inner Sphere. All Houses have manufacturers who make the J-27, as do even the larger Periphery nations. Acme's licensing fees are so low that none feel the need to redesign the transport even cosmetically outside of the name plates and logos. Among smaller Periphery realms

and lawless lands, the J-27 can be a rare commodity, well worth stealing.

Ever since the Free Worlds League began using the J-27 as a penal option, this practice has been emulated by all but Houses Steiner and Davion as the primary source of J-27 crews. Houses Steiner and Davion feel that munitions handlers should be more reliable than criminals, but still use J-27 duty as a punishment for soldiers.

The most famous of the penal units is undoubtedly the 125th Deadman Ordnance Carriers serving the Capellan Confederation. During fighting for New Hessen, the unit carried over a thousand times their own mass in munitions to keep Capellan forces in a defensible position. The unit actually found some of its convoys under fire from a pair of Davion 'Mechs. Rather than flee, they actually removed some of their missiles and made make-shift firing positions, driving the attackers from the field after a few hours of combat. The crews were given pardons and promotions to other units, but some elected to stay.

Variants

A few crews have been able to modify their transports with more armor at the expense of some of the machine gun ammunition. Even rarer are those with scavenged fusion engines allowing faster movement, which tend to be original Star League J-27s. The only combat variant is the K-27 "Killjoy," a version modified to look like a typical J-27 but mounting a missile launcher and more armor. The Federated Suns makes a few dozen of these each year to make enemies think twice about attacking their transports.

Notable Crews

Captain "Jumpin' Jake" Jackson III: The commander of the 125th Deadman, he elected to stay with his unit. Despite his murder conviction and dislike of officers, he has advanced after New Hessen. He still commands from a J-27, carrying ammo for his crews.

J-27 ORDNANCE TRANSPORT

Type: **J-27 Ordnance Transport**
 Technology Base: Inner Sphere
 Movement Type: Tracked
 Tonnage: 10
 Battle Value: 47

Weapons and Ammo	Location	Tonnage
Machine Gun	Turret	.5
Ammo (MG) 200	Body	1
Cargo	Body	3
Trailer Hitch	Rear	0

Trailer
 Technology Base: Inner Sphere
 Movement Type: Wheeled
 Tonnage: 10
 Battle Value: 39

Equipment	Mass
Internal Structure:	1
Engine:	3
Type:	ICE
Cruising MP:	5
Flank MP:	8
Heat Sinks:	0
Control Equipment:	.5
Lift Equipment:	0
Power Amplifier:	0
Turret:	.5
Armor Factor:	8
	<i>Armor Value</i>
Front	2
R/L Side	1/1
Rear	2
Turret	2

Equipment	Mass
Internal Structure:	1
Engine:	0
Type:	N/A
Cruising MP:	N/A
Flank MP:	N/A
Heat Sinks:	0
Control Equipment:	0
Lift Equipment:	0
Power Amplifier:	0
Turret:	0
Armor Factor:	16
	<i>Armor Value</i>
Front	4
R/L Side	4/4
Rear	4

Weapons and Ammo	Location	Tonnage
Cargo	Body	8
Trailer Hitch	Front	0



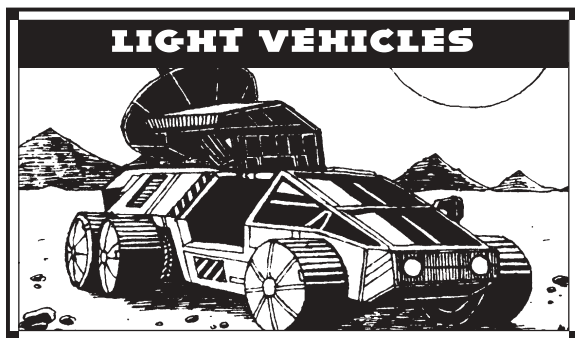

Mass: 20 tons

Movement Type: Wheeled

Power Plant: VOX 80 Fusion

Cruising Speed: 54 kph

Flank Speed: 86 kph

Armor: StarSlab/Sheet

Armament:

2 ChisComp 32 Small Lasers

Manufacturer: Various

Primary Factory: Various

Communications System: Achernar Electronics
HICK-4

Targeting and Tracking System: Mercy Industries
of Talon

Overview

Mobile Army Surgical Hospitals—MASH for short—have been in existence since the mid-twentieth century. Designed to patch up military personnel in the midst of a battlefield, the MASH system began as a conglomeration of buildings the size of a small town. “Mobile” in name only, these hospitals often required several days to fully pack up and change locations. As warfare progressed through the centuries, the MASH concept remained a vital part of the support and logistical chain but only slowly evolved into the current configurations seen in today’s modern war zone.

Capabilities

The MASH unit is quite capable of providing the highest quality medical care for injured soldiers. Depending on the military, they can be manned by civilian or military surgeons as its facilities permit even the most delicate of operations, provided enough medical supplies are present.

The interior of a MASH truck is a high-tech affair once unfolded and unpacked. When a wounded patient has been prepped, he is placed on an automated table that provides the surgeon with everything necessary for the operation. Robotic arms administer anesthesia, dispense instruments, and provide continuous reports on the patient’s condition via several nearby monitors and through a small earphone worn by the surgeon. The system can even provide a “quick freeze” via a sealed container that is flooded with a clear, oxygen-rich liquid. The surgeon can then continue vital procedures through sleeves leading into the isolated area with the table providing instruments from underneath the cover.

All care is computerized, from triage to post-op care, and recorded to the soldier’s personal identifier. That data is then transmitted via satlink to command and control so that when the patient is transferred to a field hospital or DropShip, the data is already available for continued care.

In emergency situations, the MASH can partially fold up and then transport a surgeon and his patient while procedures continue. The computerized transmission and wheelbase adjust for rough terrain and provide as stable an environment for the surgeon as possible.

The MASH is lightly armed, more to discourage thieves than to inflict damage. Some doctors have had the weapons removed and additional storage or backup generators installed, due to their convictions as healers. Most MASH units within the Confederation still retain their small laser batteries or have swapped them out for a one-shot missile package.

Deployment

MASH units can be found in every army’s support structure on every world, though the design presented here is the Davion version. Even basic planetary militias have at least one operational MASH truck available. Larger House units have fleets of them; the Davion Brigade of Guards is known to have over 250 units assigned to them.

Variants

MASH trucks vary only in an operational capacity: there are ones for triage, operation theaters, temporary post-op recovery, and medical/pharmaceutical storage. Basic MASH units consist of at least a triage and theater truck. The White Whales of the FWL consist of long convoys of white MASH units, usually mostly theater and supply units.

After the Succession Wars, some MASH trucks were converted to ICE engines due to the dwindling supply of fusion engines. However, the power requirements proved to be high enough that the swap was deemed unfeasible—too many surgeons were reporting system outages in the middle of critical procedures. No ICE-equipped MASH trucks have been in service since 2815.

Notable Crews

Major Kaplan Bowes: Former commander of the Third Crucis Lancer’s MASH arm in the late 28th century, Bowes received the Caducean Sunburst for “medical bravery in the face of enemy fire.” Refusing to relocate his MASH command during a concentrated Kuritan push, his ten-truck MASH unit was overrun while performing critical surgery on several wounded tankers. As the Kurita commander approached the major’s theater, Bowes quickly stepped out of the unit, bowed to the commander, and told him he would surrender the entire unit after all the men were cared for. He then instructed his orderlies to gather up the DCMS wounded for treatment as well. Seven hours later—while still caring for the wounded that kept rolling in (Davion and Kuritan alike)—the battle lines shifted again, and the Lancers regained control of the area around the MASH command. Bowes insisted the DCMS soldiers under his care be released to the enemy and sent three loaded post-op units to the Kuritan lines the next day. When the Kurita forces lifted from the system, the MASH trucks were found at the edge of the DMZ, with the commander’s sword and a personal note “to the *gajjin* doctor” on the driver’s seat.

MOBILE ARMY SURGICAL HOSPITAL

Type: **MASH Truck**

Technology Base: Inner Sphere

Movement Type: Wheeled

Tonnage: 20

Battle Value: 220

Equipment

Internal Structure:

Engine:

Type:

Cruising MP:

Flank MP:

Heat Sinks:

Control Equipment:

Lift Equipment:

Power Amplifier:

Turret:

	Mass
Internal Structure:	2
Engine:	4
Type: Fusion	80
Cruising MP:	5
Flank MP:	8
Heat Sinks:	10
Control Equipment:	1
Lift Equipment:	0
Power Amplifier:	0
Turret:	.5

Equipment

Armor Factor:

Front

R/L Side

Rear

Turret

Weapons and Ammo

2 Small Lasers

MASH Equipment

(5 Theaters)

Location

64

Armor

Value

12

16/16

10

10

Turret

Body

Mass

4

Tonnage

1

7.5

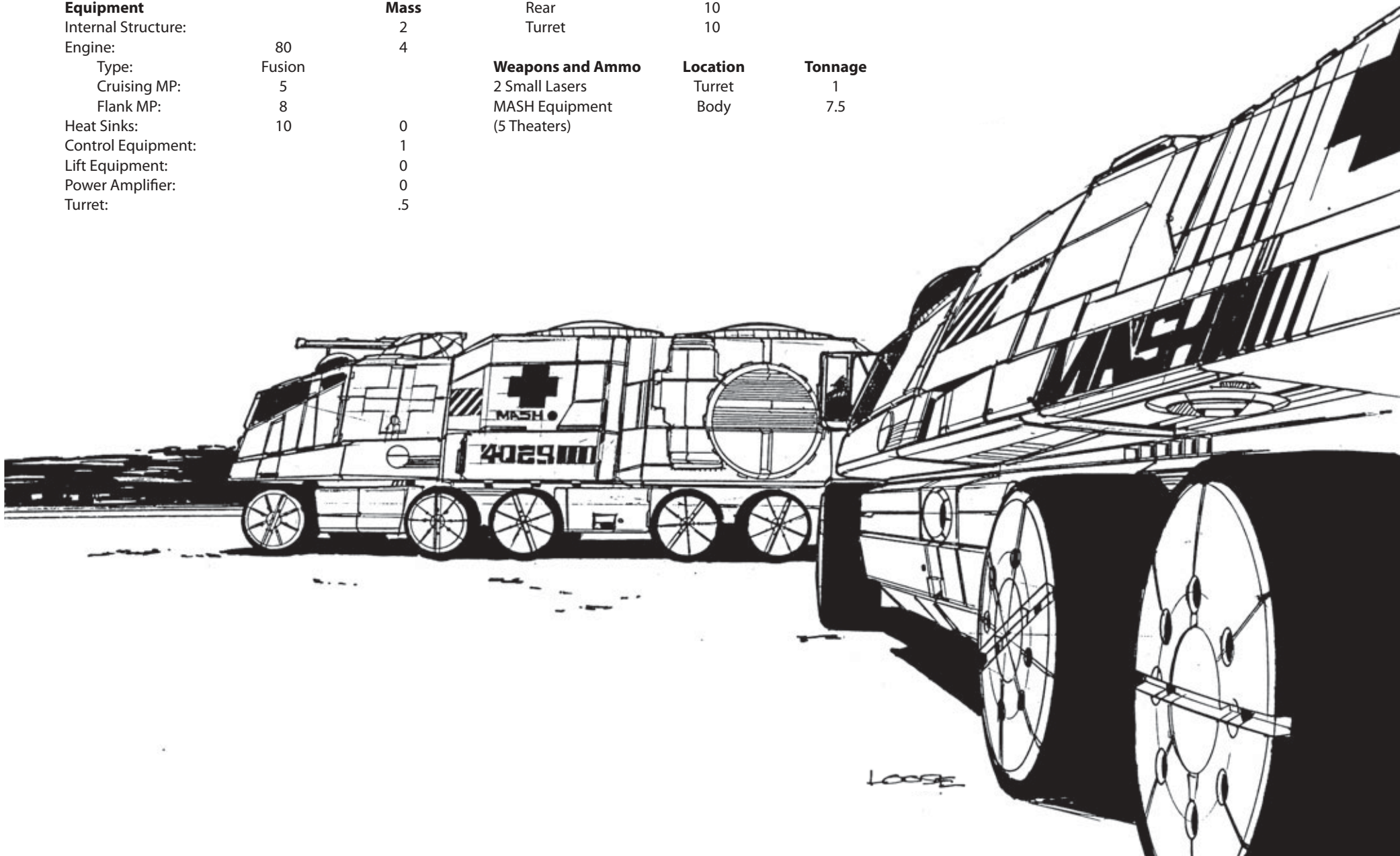

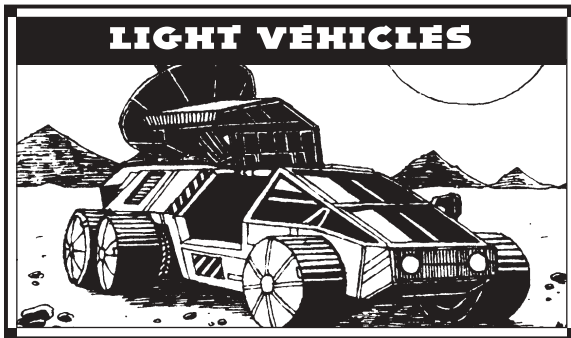

Mass: 20 tons

Movement Type: Wheeled

Power Plant: Doorman 120 Fusion

Cruising Speed: 75 kph

Flank Speed: 118 kph

Armor: StarSlab/1

Armament:

1 Harvester 20K Six-Rack Short-Range Missile

1 HS Flamer

Manufacturer: Bowie Industries, Gienah
Combat Vehicles

Primary Factory: Carlisle, Gienah

Communications System: O/P COMTES

Targeting and Tracking System: O/P 2000JSA

Overview

The Packrat Long Range Patrol Vehicle was originally designed by Robertson Technologies as an independent raiding and reconnaissance vehicle that could operate and survive away from established supply lines for a large period of time. Well-armored, fusion-powered, and lavishly-appointed, the Packrat accomplished its mission objectives time and time again throughout the Succession Wars.

The resurgence of military industry profited the Packrat as much as any other vehicle. Now in standard production in two facilities in the Lyran Commonwealth, the Packrat is spreading across the Inner Sphere as House militaries recover from the ravages of the Fourth Succession War.

Capabilities

A Doorman 140-rated fusion engine frees the Packrat from reliance on fuel, giving it both exceptional speed and an almost-unmatched mobility. Its wheeled chassis is well-suited to long-range travel. Eight solid-rubber tires cannot be deflated and provide superior traction on a variety of surfaces, both on-road and off. Four tons of StarSlab armor provide fantastic protection for a vehicle of its class, while a six-tube Harvester short-range missile system give the Packrat a respectable barrage capability. Although not intended for frontline combat, the Packrat can hold its own during limited engagements.

Although not a dedicated infantry transport, the Packrat provides space for up to ten passengers. These spaces are most often filled with mission specialists like intelligence analysts or infiltrators. An HS flamer mounted on the rear and fed from the Doorman provides an excellent concealment method if the Packrat is discovered.

The true marvel of this vehicle, however, is the powerful O/P COMTES communications system, one of the most powerful for its size ever mounted on a combat vehicle. Although not as powerful as the Star League-era systems beginning to reappear in Successor State militaries, the O/P can provide local signals and ECM capabilities.

Deployment

Although both modern production facilities are located in the Lyran Commonwealth, the Packrat can be found in every House military and in several larger Periphery states. Its reputation as the preeminent long-range recon vehicle is well deserved and respected. The Packrat is especially popular in the Federated Suns' March Militias, where its durability and versatility are greatly prized.

Although the ravages of the Succession Wars mandated the replacement of the Doorman fusion engine with a less-efficient ICE, the technological recovery of the 3030s allowed Bowie Industries to begin manufacturing the Packrat to its original specifications. After the Bowie production lines had been building the original model barely a year, Gienah converted its ICE-model production line to the fusion model in 3040.

Variants

As with any combat vehicle, there are more reported variants and modifications of the Packrat than there is space to list. Several models attempt the same goals by different means, with the exact technologies varying by military establishment. In the Capellan Confederation many units replace the Harvester six-rack with the commonly available Hovertec twin-tube launcher, allowing the Packrat to carry a full platoon of leg infantry. Planetary militias on several Free Worlds League worlds have stripped the flamers and passenger space for a pair of medium lasers.

A large number of ICE-equipped Packrats are spread across the Inner Sphere, but early maintenance records are already showing these vehicles the first to be judged irreparable so they can be scrapped in favor of now-available fusion-powered replacements.

Notable Crews

Leutenant Gerhardt Bernhard: Bernhard and his Packrat "Missy" are attached to the Second Battalion of House Steiner's Twenty-Sixth Lyran Guards. Missy and then-sergeant Bernhard first came to prominence during the Fourth Succession War, when they were instrumental in securing a number of tactical successes against House Kurita. Bernhard would often sneak his Packrat far around the Kuritan flanks and then race inward, scouting the rear positions and radioing the information back to the Lyran 'Mech forces. Rumors continue to circulate that he delivered a number of Loki teams behind the DCMS lines as well, but Bernhard has never admitted to the deed.

Kashira Takeshi Onaki: A recon specialist with the Second Legion of Vega, Onaki is currently driving his fourth consecutive Packrat. The previous three have been lost in combat against various units of House Davion while raiding Federated Suns worlds. Onaki is supremely skilled at maneuvering his vehicle around Davion patrols, but once he has broadcast his information to waiting Kurita units, he stops trying to hide his position and instead engages the nearest enemy unit in combat as a true samurai should. To date, he has successfully destroyed ten Davion light vehicles and two *Wasps*.

PACKRAT LONG RANGE PATROL VEHICLE

Type: Packrat Long Range Patrol Vehicle

Technology Base: Inner Sphere

Movement Type: Wheeled

Tonnage: 20

Battle Value: 344

Equipment

Internal Structure:

Engine:

Type:

Cruising MP:

Flank MP:

Heat Sinks:

Control Equipment:

Lift Equipment:

Power Amplifier:

Turret:

Mass

2

6

120

Fusion

7

11

10

0

1

0

0

0

Equipment

Armor Factor:

Front

R/L Side

Rear

Weapons and Ammo

SRM 6

Ammo (SRM) 30

Flamer

Infantry Bay

Location

Front

Body

Rear

Body

64

Armor

Value

16

16/16

16

Mass

4

Tonnage

3

2

1

1

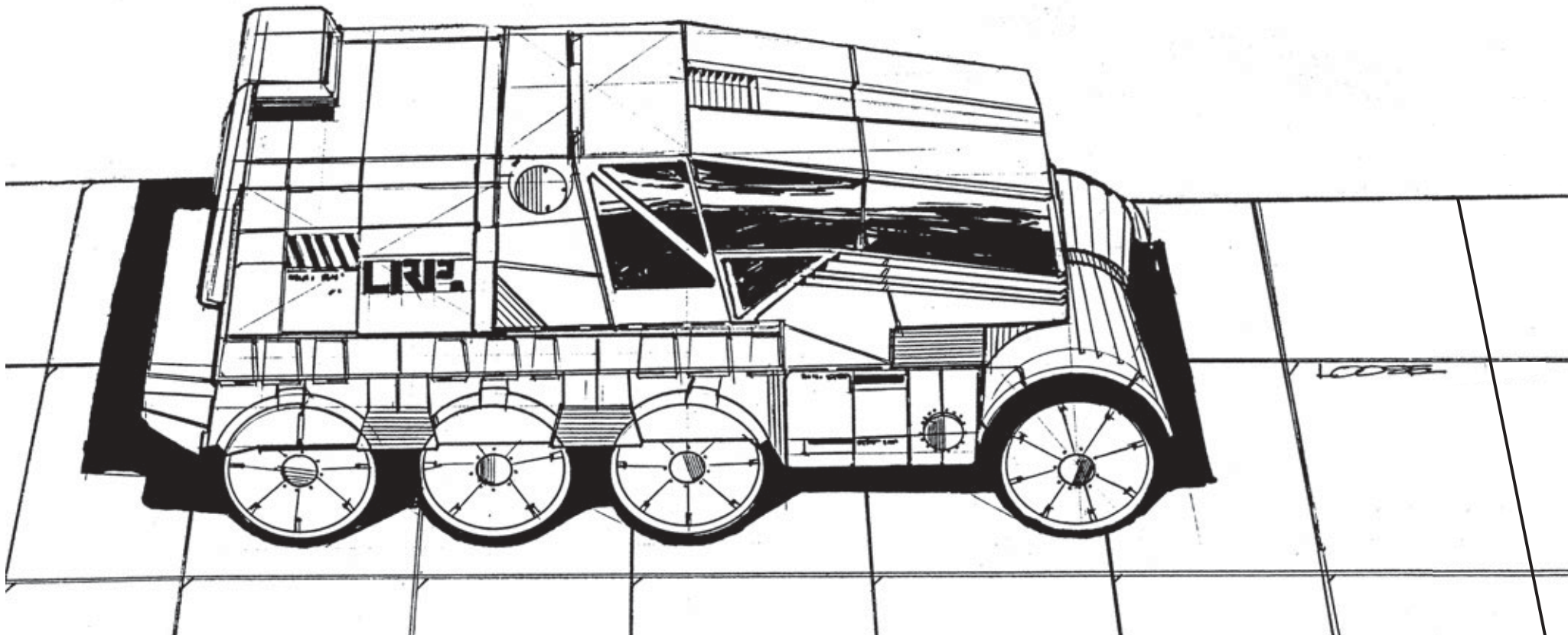

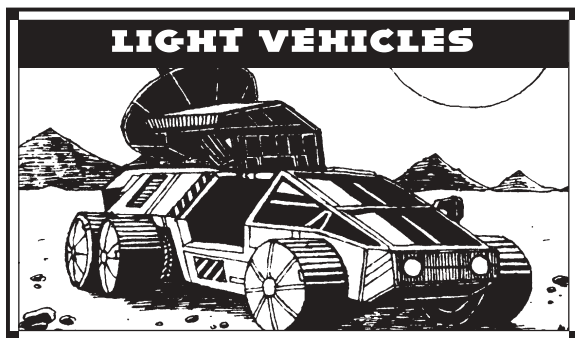

Mass: 20 tons

Movement Type: Wheeled

Power Plant: GM 120 Classic ICE

Cruising Speed: 75 kph

Flank Speed: 118 kph

Armor: ProtecTech Light

Armament:

1 Standard Systems Medium Laser

Manufacturer: Joint Equipment Systems

Primary Factory: Alshain

Communications System: Communicate Equipment

Targeting and Tracking System: Targeting System 2.3

Overview

While there are many different scout units manufactured, most are small, quick vehicles. Joint Equipment Systems decided to go a different route by making a larger and roomier vehicle. While somewhat slower, the Skulker does its job well and crews actually request assignment to the Skulker, unlike many other scouting units. While the Skulker only requires two crew, it has quarters for four. This often allows extended hours of operation as the crew rotates throughout the mission, vital for scouting missions that can involve a lot of hurry up and wait.

Capabilities

With a cruising speed of 75 kph, the Skulker can outpace most military formations and in combat situations can accelerate to nearly 120 kph, allowing it to elude pursuit. If

that wasn't enough, four-and-a-half tons of armor is more than many combat vehicles its size. For offense, the Skulker mounts a medium laser, ideal for long-range missions with minimal resupplying. To accomplish its main mission, an advanced sensor suit has been tied into both the targeting and communication systems. Software allows the driver to navigate using the sensor system.

Very hot environments often wreak havoc on advanced electronics like those the Skulker mounts, but by allowing the heat sinks to cool the sensors when the laser is not in use, the Skulker can operate on the hottest planets without worrying about damage to the electronics. Since the Skulker's missions can often last up to a week at a time, designers allowed for a very roomy crew area complete with an entertainment system. Alarms tied into the sensor system trigger if the sensors detect threats, allowing the crew to relax some without being entirely off guard.

Deployment

The primary scouting vehicle for the Draconis Combine, almost all Combine conventional units possess at least one Skulker. The roomy, comfortable interior makes the Skulker popular among scouting crews who can get them in other nations. The secondhand market for Skulkers is very lively, as are JES's sales when the Combine permits export of the tank. Sales to the Capellan Confederation and Free Worlds League have increased since the cessation of the Fourth Succession War.

In the late 30th century, Spicher's Strikers invaded Dieron for the Federated Suns. They established a good beachhead and set up a defensive perimeter around the town of Arlington Grove. Their picket forces noticed Skulkers around the edges, but Major Spicher ignored them. He moved his entire force out in a tight formation and drove the Combine forces back despite the advanced warning from the Skulkers. In control of the battlefield, Spicher's recovery and transport units went to the battlefield under cover of their reserve units. After recovering all that was worth recovering, they returned to their base of operations, only to find it ravaged. The support staff with small arms was no match for the Skulkers' armor and lasers. While the Strikers had battlefield salvage, they were out of

food, fuel, and ammo. Despite their battlefield success, the Strikers had to retreat off planet with their tails between their legs.

Variants

Most variants are mainly cosmetic in design, altering the Skulker for different environments. A few Skulkers attached to planetary militia units swap out the laser and associated heat sinks for a missile system or machine guns for anti-infantry defense. The crew quarters were designed for easy modification, so crews frequently optimize their Skulker for their needs and habits.

Notable Crews

Matahari: Probably the most technologically advanced Skulker ever, the Matahari has been modified by the Capellan Confederation with baffles and insulation to make it quieter. Even heat emissions are distributed better, and it can often drive slowly past enemy sensors. While the so-called "Stealth Skulker" is no more effective in combat, it has kept House Liao aware of enemy action for almost half a century.

Justin and Elizabeth Baughman: Where the grueling demands of long range recon can test some partnerships, this married couple actually enjoys traveling behind enemy lines together. Originally from Terra, people often ask Elizabeth about her past in England, but she prefers to focus on the future. The Baughmans were instrumental in taking the planet Liao during the Fourth Succession War. Capellan forces were mounting a counterattack after a successful Davion landing, so the Baughmans befriended some locals who were sick of the crippling shipping taxes Sian had imposed and the cruel machinations of Capellan Colonel Manuel. Using these contacts, the Baughmans kept the Federated forces up to date on almost all of the Capellan forces.

SKULKER WHEELED SCOUT TANK

Type: **Skulker Wheeled Scout Tank**

Technology Base: Inner Sphere

Movement Type: Wheeled

Tonnage: 20

Battle Value: 314

Weapons and Ammo

Medium Laser

Cargo

Location

Front

Body

Tonnage

1

.4

Equipment

Internal Structure:

Engine: 120

Type: ICE

Cruising MP: 7

Flank MP: 11

Heat Sinks: 3

Control Equipment:

Lift Equipment:

Power Amplifier:

Turret:

Armor Factor: 72

*Armor
Value*

Front 18

R/L Side 18/18

Rear 18

Mass

2

8

3

1

0

.1

0

4.5

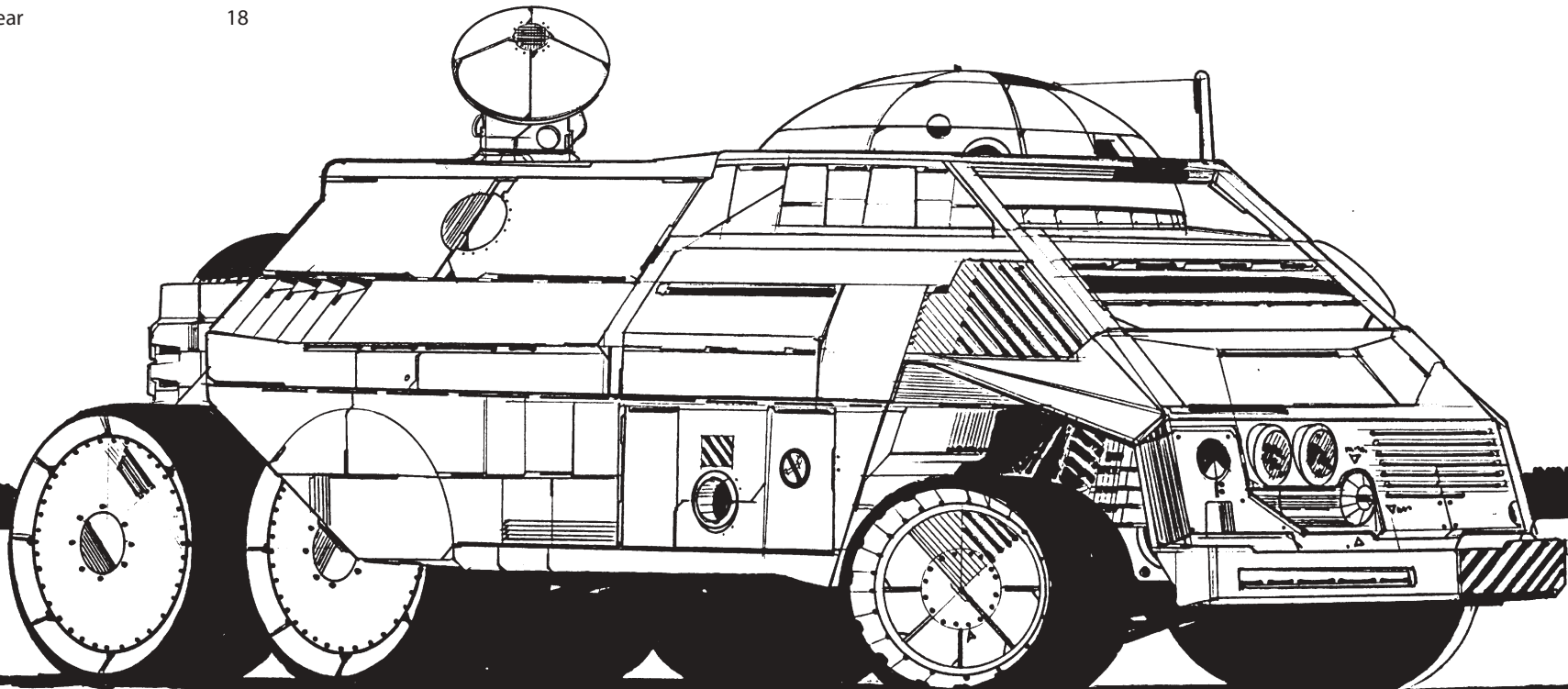

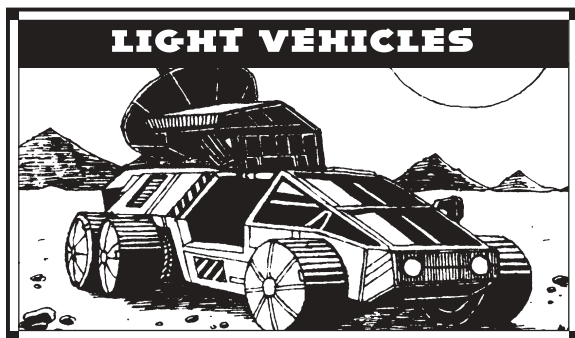

Mass: 21 tons

Movement Type: VTOL

Power Plant: Omni 50 ICE

Cruising Speed: 97 kph

Flank Speed: 151 kph

Armor: Longanecker PlastiSteel

Armament:

1 SarLon Autocannon/2

1 TharHes 4 Pack SRM 4

Manufacturer: Lockheed/CBM Corporation

Primary Factory: Furillo

Communications System: Xilex-2000

Targeting and Tracking System: N&D Handsfree

Overview

The Warrior has spent the last ninety years rebuilding the combat reputation of the helicopter. Produced by the Lockheed/CBM Corporation on the Commonwealth world of Furillo, the Warrior is a single-person attack helicopter often found in mercenary and Periphery air cavalry units. Its combination of high speed and long-range weaponry make it an ideal platform for maintaining contact with an enemy while the main body maneuvers into position.

Although the initial production figures were low due to the Lyran Commonwealth Armed Forces' arrogance when it came to "flying toys," the Warrior eventually found its way into the LCAF's armored forces and quickly spread across the Inner Sphere.

Capabilities

The Warrior's main weapon is a centerline-mounted automatic cannon, the venerable SarLon Autocannon/2. The phenomenal range profile of this weapon allows the Warrior to engage while remaining far out of range of the enemies' weapons. Although it's not a powerful cannon, the SarLon is reliable and packs enough punch that not even a BattleMech can afford to ignore it for long. Supporting the SarLon is a locally-produced TharHes four-tube short-range missile system, which gives the Warrior a respectable bombardment capability during high-speed strafing runs.

The innovative N&D Handsfree targeting and tracking system is unique to the Warrior. This system uses a high-tech helmet to mate the reticle-mounted targeting crosshairs to the pilot's vision. Instead of having to take his hands off the controls to manipulate a complex firing panel, the pilot simply maneuvers the helicopter until his crosshairs line up with the projected target and fires. Although the technology is relatively simple and pales in comparison with the complexity of a 'Mech's neurohelmet, the N&D is still an impressive piece of work.

Unlike most helicopters, the Warrior does not have an anti-torque tail rotor. Instead, it mounts two sets of rotors on its mast, each rotating in opposite directions to cancel the engine's torque. The tail still finds a use with ducted fan, which provides additional thrust to propel the Warrior at truly impressive (and hard-to-target) speeds.

Despite these advantages, however, the inherent fragility of all vertical-take-off-and-landing craft remains the Warrior's greatest flaw. Pilots who realize their danger and fly the craft the way it was designed find it to be an asset on any mission, but many careless commanders, unfamiliar with the mobile nature of helicopter warfare, send the Warrior to battle in the same manner they would a tank, which usually results in the destruction of the helicopter and the death of the pilot.

Deployment

Since its initial deployment in 2957, the Warrior has spread to every Successor State and several Periphery realms. House Davion's Ceti Hussars make extensive use of

the Warrior, as do the Free Worlds Guards and the Capellan Home Guard. A number of smaller mercenary units also employ the craft, including one or two helicopter-only units such as Laws Flight, famous for their defense of Kimball II in 3021. More recently, during the Fourth Succession War, several units of airmobile troops supported by Warrior attack helicopters played vital roles in Hanse Davion's invasion of the Capellan Confederation.

Variants

The main complaint of commanders and pilots is the SarLon's lack of punch. Lockheed/CBM introduced two variants to address this concern. The H-7A replaces the short-range missiles with a machine gun and upgrades the autocannon to a larger SarLon Maxicannon 5. The H-7C takes a different approach, replacing the SarLon entirely with a long-range missile battery.

Notable Crews

Leftenant Bianca Graymond: Recently declassified reports of an action on Palos during the Fourth Succession War paint then-Sergeant Bianca Graymond as one of the premier Warrior pilots of the modern age. Detached from her parent unit, along with a full company of Warriors and two battalions of airmobile infantry, Sergeant Graymond led the diversionary attack on a 'Mech lance while the infantry battalions assaulted their target, a suspected nerve gas depot.

Sergeant Graymond and her flight of four Warriors chose a Capellan *Commando* BattleMech as their target. Using high-speed strafing runs combined with bouts of long-range sniping, Sergeant Graymond and her Warriors held the 'Mech's attention for almost forty minutes, leading it on a ten-kilometer chase away from the depot. While she and all her pilots were eventually brought down and killed by laser and missile fire, her heroism allowed the infantry battalions to capture the depot. While no weapons of mass destruction were found, Sergeant Graymond received (posthumously) the Diamond Sunburst for bravery and a promotion to leftenant.

WARRIOR H-7 ATTACK HELICOPTER

Type: **Warrior H-7 Attack Helicopter**

Technology Base: Inner Sphere

Movement Type: VTOL

Tonnage: 21

Battle Value: 289

Equipment

		Mass
Internal Structure:		2.5
Engine:	50	3
Type:	ICE	
Cruising MP:	9	
Flank MP:	14	
Heat Sinks:	0	0
Control Equipment:		1.5
Lift Equipment:		2.5
Power Amplifier:		0
Turret:		0

Equipment

Armor Factor:	24	Mass	1.5
	<i>Armor</i>		
	<i>Value</i>		
Front	6		
R/L Side	5/5		
Rear	6		
Rotor	2		

Weapons and Ammo

	Location	Tonnage
AC/2	Front	6
Ammo (AC) 45	Body	1
SRM 4	Front	2
Ammo (SRM) 25	Body	1

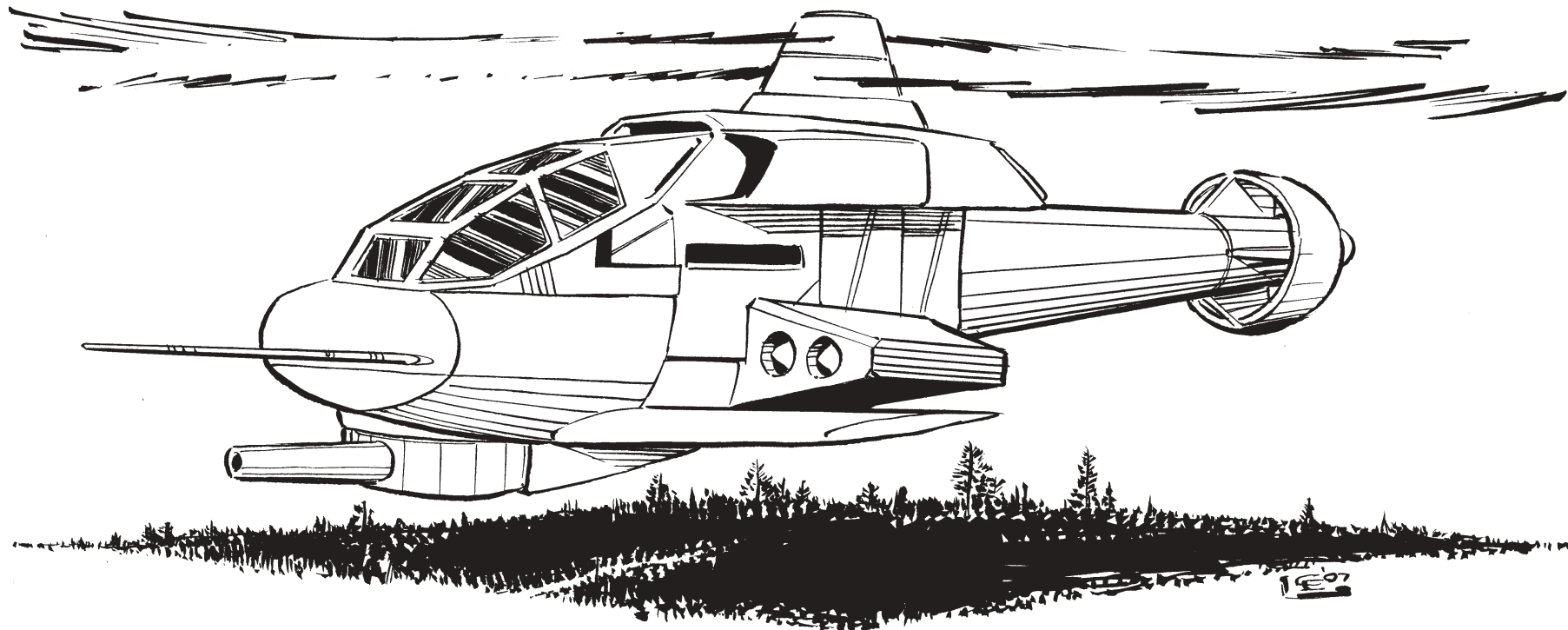

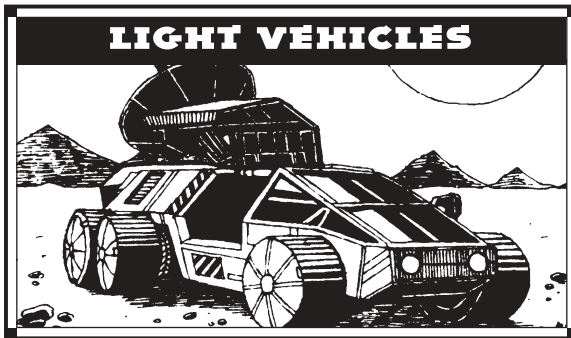

Mass: 25 tons

Movement Type: Hover

Power Plant: GM 120 Classic II ICE

Cruising Speed: 108 kph

Flank Speed: 162 kph

Armor: StarSlab/2

Armament:

2 SureShot Mk VI SRM 6

Manufacturer: Brooks Incorporated

Primary Factory: Suzano, Irian, Andurien

Communications System: Maxell 500

Targeting and Tracking System: Maxell TA 55

Overview

Looking to compliment the sizeable force of Galleon light tanks acquired during the fall of the Star League, the Free Worlds League commissioned Brooks Incorporated to create a companion vehicle for their tracked vehicle. Deciding against doing a more traditional companion, a similar motive system with longer-range capabilities for support, designers instead opted for a swifter hover tank with equally short-ranged firepower.

Capabilities

The Harasser's speed combined with its formidable pair of SRM 6 racks have garnered Harasser units the nickname "Poor man's artillery," as the lightweight hovercraft could deliver concentrated firepower quickly across a raging battlefield.

The speed and firepower come at a price. Only a ton and a half of armor protects the entire machine, allowing a single medium laser hit to strip or penetrate any location on the hover tank. This often led to many quickly destroyed Harassers, as the first heavy weapons hit would push through to the engine or the large ammunition bin, leading to a spectacular explosion. Many Harasser commanders force their vehicles to spread out and move at top speed, as artillery and bottlenecks will often lead to the graveyard for the light craft.

Brooks attempted to install a back-up fire control for the commander, allowing the commander to re-align and fire the turret mounted weapons, but a string of accidents and misfirings by commanders simply trying to realign the turret forced Brooks to do a recall, disabling and removing the back-up control from the Harassers. Only a few hundred outside of the Free-Worlds League borders still have this feature.

Deployment

Though developed to be teamed with the Galleon, the massive casualties received during the outbreak of the Second Succession War forced the League Military to employ the Harasser throughout many local militias, as the regular military units were spread too thin to conduct effective defensive operations. This propagation would continue until the Inner Sphere nearly exhausted itself militarily and ended the Third Succession War, giving the Free Worlds League enough breathing room to finally employ the Harasser as intended.

Originally, the theory was that the Harassers would surge ahead of the main formation, softening up an enemy force and drawing them to the incoming Galleons, who would do a swift pass and encircle the group. However, the few times this was attempted, the enemy force would refuse to take the bait, forcing a second attempt and increased casualties among the lightly armored hover tanks.

Instead, commanders began switching roles between the two vehicles, leaving the Harassers behind hidden, while the Galleons engaged the enemy. With the focus entirely on the better-armored tanks, the Harassers would then spring out of hiding and flank the force, using their devastating firepower to quickly end the fight.

Variants

The constant tinkering of the Harasser/Galleon combination has led to a number of variants for the small hover tank. One version uses a long-range missile rack to provide swift fire support, while another uses lasers originally mounted on scrapped Galleons to further streamline logistics and extend a Harasser's endurance time. Some others use flamers, or advanced sensors (nick-named "Mini-Peggies"), but those are rare and used for special operations.

Notable Crews

Force Commander Bill Gorhum: Commander of the planetary militia of Nestor, a force composed mainly of Harassers, Force Commander Gorhum re-organized his tank corps back to the Star League standard, allowing him to keep several additional platoons in reserve. Lyran commanders familiar with the Free Worlds League policy of enlarged tank platoons believe upon first contact that Gorhum's tank corps is operating merely under-strength until the raiding group finds their rear guard swarmed with the reserve of Harassers.

Leaping Lisa: A experiment that followed a League battle with a group of Kanga jump tanks during the First Succession War, Leaping Lisa was a Harasser modified by reducing the SRM packs in size and adding on several jump jets on the sides to increase its mobility in pent-up locations. The League did not, unfortunately, know about the advanced stabilization systems used by the Kanga, and Leaping Lisa's first test run was a spectacular failure, as it flipped over and crashed on its rear during its first attempt at leaping, detonating the ammunition bay and killing its crew. The Free Worlds League banned any informal attempts of similar experiments after that incident.

HARASSER MISSILE PLATFORM

Type: **Harasser Missile Platform**

Technology Base: Inner Sphere

Movement Type: Hover

Tonnage: 25

Battle Value: 413

Equipment

Internal Structure:

Engine: 120

Type: ICE

Cruising MP: 10

Flank MP: 15

Heat Sinks: 0

Control Equipment:

Lift Equipment:

Power Amplifier:

Turret:

Armor Factor: 24

Armor Value

Front 5

R/L Side 5/5

Rear 4

Turret 5

Weapons and Ammo

2 SRM 6

Ammo (SRM) 30

Location

Turret

Body

Mass

2.5

8

0

1.5

2.5

0

1

1.5

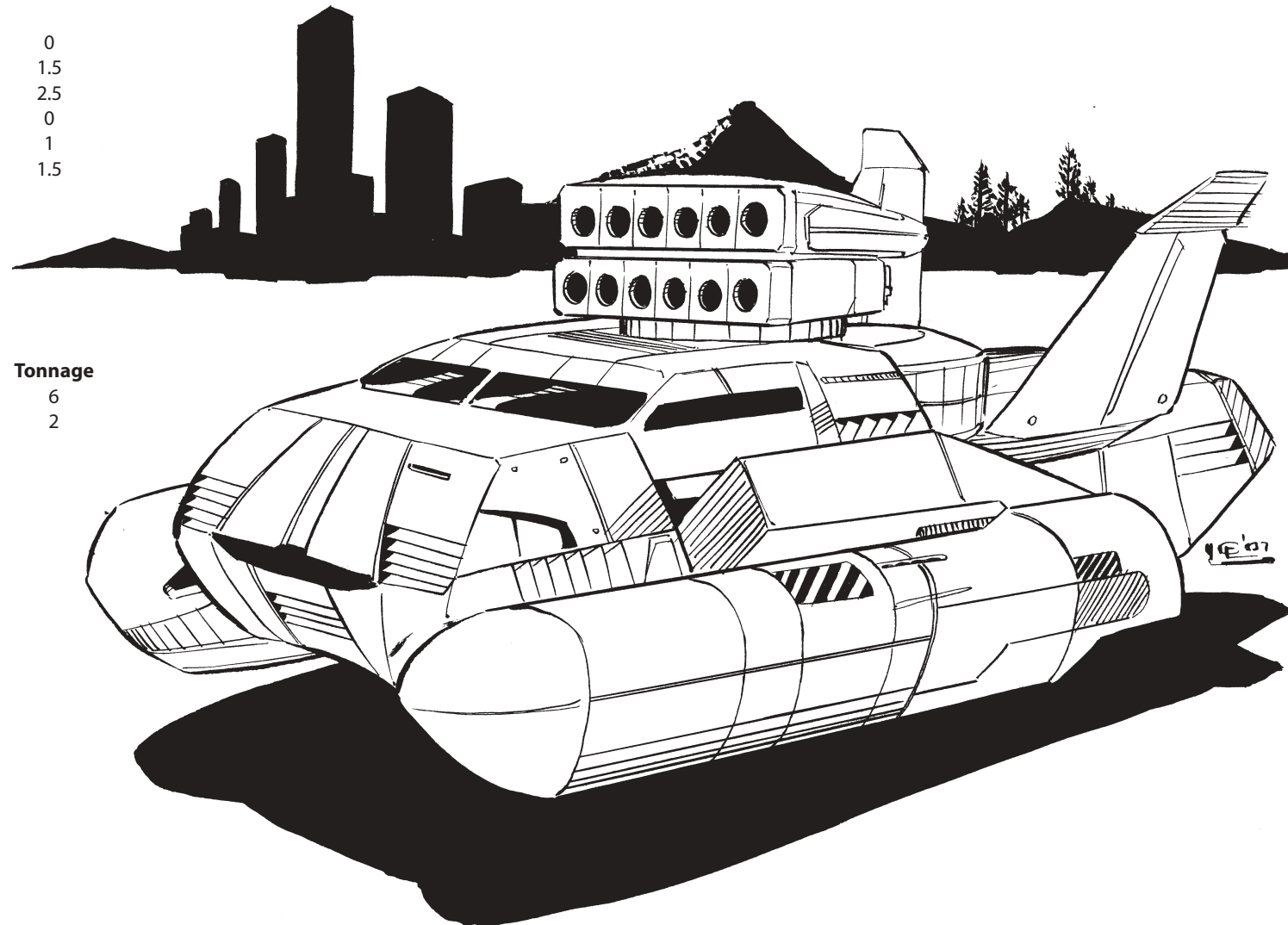

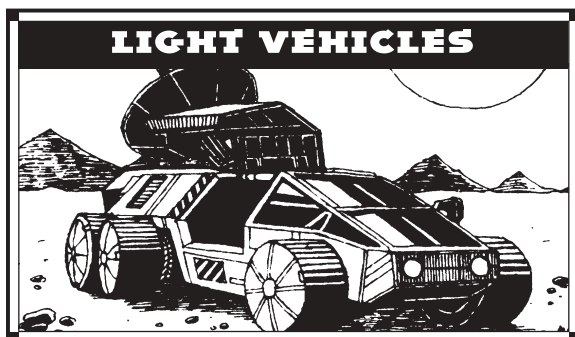

Mass: 25 tons

Movement Type: Hover

Power Plant: 145 Leenex Fusion

Cruising Speed: 118 kph

Flank Speed: 183 kph

Armor: StarSlab/7

Armament:

1 Diverse Optics Type 18 Medium Laser

2 Harvester SRM 2 Missile Racks

Manufacturer: Olivetti Weaponry,
Pinard Protectorates Limited

Primary Factory: Sudeten (Olivetti),
Perdition (Pinard)

Communications System: Alphard Original Two
(Olivetti), Neil 5000 (Pinard)

Targeting and Tracking System: RCA Instatrac
Mk. II (Olivetti), TracTex Alpha-1 (Pinard)

Overview

The J. Edgar is one of the few vehicles produced by the Alphard Trading Corporation. To expand its market and increase profits, ATC decided to make a number of both military and civilian vehicles to sell to any world, government, or person willing to buy them. Although the vehicles sold fairly well initially, the diversification failed as the years passed, and ATC closed down all vehicle manufacturing facilities in 2732.

The J. Edgar was the last military vehicle that the Alphard Trading Corporation produced. Designed as a cheap, fast, and effective fighter, the J. Edgar was only a marginal success during its ten-year production run. Many

expected the J. Edgar to quietly disappear, but Pinard Protectorates Ltd. licensed the design and began to manufacture it for the Taurian Concordat in 2755. In 3006, the newly created Olivetti Weaponry also began to manufacture the vehicle, though they neglected to license the design from ATC; that fact embroiled both parties in litigation that has dragged on for decades (later complicated by the Jade Falcon conquest of Sudeten).

Capabilities

The J. Edgar is a fast and sturdy lightweight hovercraft. Thanks to the 145 Leenex power plant, it can reach an impressive 183 kph—a speed few ground vehicles can match. This speed and the unlimited endurance bestowed by a fusion engine make the J. Edgar perfect for reconnaissance and raiding operations.

The Succession Wars have taken their toll on the J. Edgar. Both Olivetti and Pinard Protectorates have replaced the original Diverse Optics Type 2 medium laser with the more readily available (but less accurate) Type 18 model. The TracTex Alpha-1 Targeting and Tracking System installed by ATC is obsolete, and replacement parts are difficult to find. The Neil 5000 has become the standard communications replacement unit.

Unlike the laser weaponry and targeting systems, the Harvester Corporation's SRM 2 rack were part of the original specifications and remains a popular missile system. They are fairly effective against vehicles and infantry but pose little threat to a 'Mech.

Deployment

The J. Edgar was used extensively by the reconstituted Taurian Defense Force during the New Vandenburg Revolt. The vehicle subsequently became a core unit in Taurian light armor formations.

The Draconis Combine bought many of ATC's original run of production, but two centuries of attrition reduced their numbers significantly. Increasingly difficult to maintain, most of the survivors were relegated to armor units supporting the Legion of Vega and the Ghost Regiments. Both commands used the speedy J. Edgar to great effect as swift raiders during the 3039 counter-offensive against the Federated Suns.

Old J. Edgars still occasionally appear with planetary militia and mercenary commands. The Com Guards also field a limited number drawn from their vast stockpiles of mothballed Star League-era equipment on Terra.

The Federated Suns gained access to new J. Edgars through the alliance with the Lyran Commonwealth that created the formidable Federated Commonwealth. While the Lyrans parcel out their vehicles piecemeal to fill gaps in their scout and light armor companies, the Davions prefer to concentrate the vehicle in companies attached to the Avalon Hussars and Deneb Light Cavalry.

Variants

The Alphard Trading Company never produced any variants, but a number of field modifications have appeared. Common variants of the J. Edgar replace the missile systems with quad machine guns or two vehicle flamers.

During the Second and Third Succession Wars, fusion engines became increasingly difficult to acquire, and those that were available were usually reserved for BattleMechs. Many J. Edgars that received engine damage were repaired using readily available internal combustion engines. This substitution resulted in a significant degradation of performance, reducing the top speed to 129 kph. Structural modifications required to fit the new power plant also necessitated the removal of one ton of armor.

Notable Crews

Stan Finch and Al Bielaski: Finch and Bielaski are the crew of a venerable J. Edgar attached to the Seventeenth Armored Recon company of the elite Twenty-first Centauri Lancers mercenary command. The pair made a name for themselves in operations along the Marik-Liao border after the Marik Civil War (also known as the Anton Revolt). They used the exceptional speed of their vehicle to run rings around the Capellan Reserves. Armed with the information gathered by the pair, Colonel Thaddeus Kusaka executed a string of devastating raids. With so many of its troops now pinned in position to guard against further attacks, the Confederation lost the opportunity to capitalize on the weakened condition of the Free Worlds League military.

J. EDGAR LIGHT HOVER TANK

Type: **J. Edgar Light Hover Tank**

Technology Base: Inner Sphere

Movement Type: Hover

Tonnage: 25

Battle Value: 546

Equipment

Internal Structure:		2.5
Engine:	145	7.5
Type:	Fusion	
Cruising MP:	11	
Flank MP:	17	
Heat Sinks:	10	0
Control Equipment:		1.5
Lift Equipment:		2.5
Power Amplifier:		0
Turret:		.5

Equipment

Armor Factor:	104	Mass	6.5
		Armor	
		Value	
Front	30		
R/L Side	19/19		
Rear	12		
Turret	24		

Weapons and Ammo

Medium Laser	Turret	1
2 SRM 2	Turret	2
Ammo (SRM) 50	Body	1

Location

Tonnage

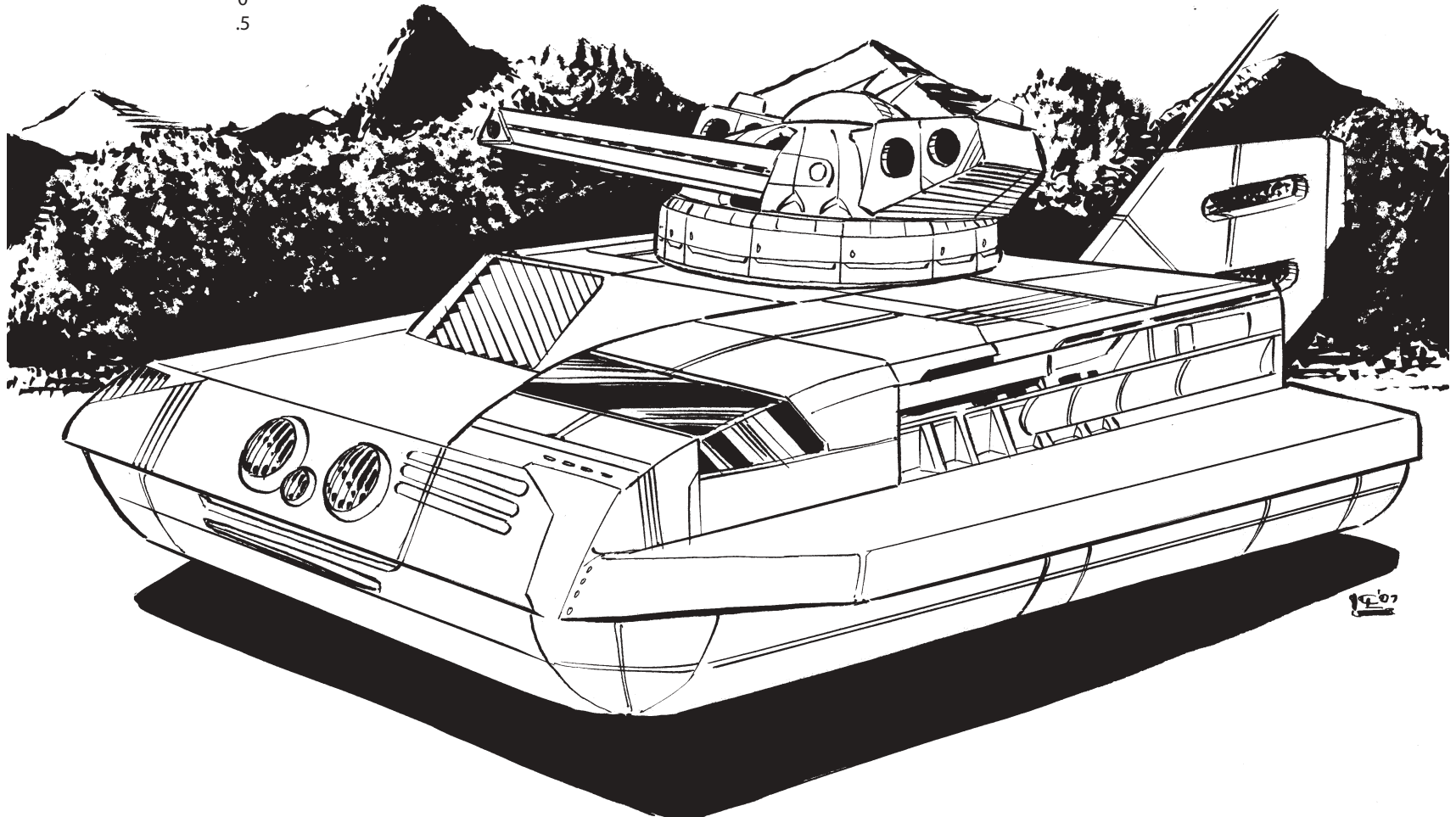

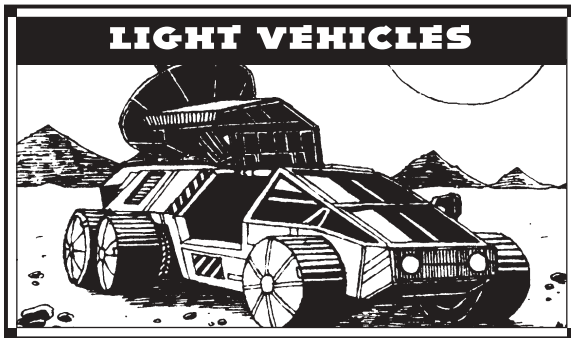

Mass: 25 tons

Movement Type: Wheeled

Power Plant: Omni 130 Fusion

Cruising Speed: 64 kph

Flank Speed: 97 kph

Armor: StarSlab/4

Armament:

1 Defiance B3M Medium Laser

Manufacturer: Star League Defense Industries

Primary Factory: Mars (destroyed 2767)

Communications System: TharHes HQ CommSet

Targeting and Tracking System: Diplan-IX
SideSweeper

Overview

Mobile headquarters have been the nerve center of large-scale planetary operations since man stepped into space. They gather information from the various participants and then use sophisticated command-and-control computer systems to present data to the commander for analysis.

The standard Mobile HQ has changed little since its introduction into the Star League Defense Force; while the cosmetic look may vary from military to military, the core systems on the inside remain the same, save for minor upgrades in technology—or, after the ravages of the Succession Wars, the failure of technology due to poor maintenance and lack of available repair methods.

Capabilities

A typical Mobile HQ is divided into two parts—the communications room and the control cab. The main communications room can seat up to six people and has room for up to twelve standing. Dominating the center of the floor is a TriHolo table, capable of showing the surrounding terrain and individual troop members, including known enemy positions. The sophisticated battle computer can also display various projections of the battle's future and possible avenues to follow based on whatever variables the commander entered into the system.

Three communications stations allow a commander and his staff of seven commtechs to maintain constant contact with their forces. The powerful transmitters are capable of piercing most jamming systems and can even connect to distant JumpShips using the collapsible main array on the roof. The interior of the communications room is kept stable by a complex and dynamic suspension system that allows normal activity within despite the speed of the truck.

Deployment

Once a common sight among most House forces, the Mobile HQ has slowly vanished from general use due to two factors: the highly technical electronics and battle computers are beyond the current know-how of most repair technicians today, and the HQs have become a legitimate target for headhunting missions ever since the Succession Wars. Those Mobile HQs still in service are usually assigned to larger, prestigious units such as the Sword of Light regiments in the Combine or the Lyran Guard in the Commonwealth. While still in service, however, most of these units are only partially functional—some no longer have working computers or TriHolo tables, others have lost the use of their multi-functional communication suites. Still, many commanders make do and have used the trucks to some success.

Variants

Variants are minor, consisting mainly of different turret weapons. Combine and Confederation forces typically mounted a long-range system, such as a large laser or LRM 10 rack, which usually required a redesign of the crew cab. These modifications are often made to those trucks that are already partially disabled due to disrepair. Most other militaries prefer to leave the medium laser.

Finding a Mobile HQ in a mercenary unit is a rare thing indeed; if one is present, a House will usually consider the Mobile HQ to be a strong mark in favor of hiring. These mercenary Mobile HQ trucks usually have an ICE engine installed for the missing fusion engine (usually stripped and sold for weapons or light BattleMechs). Such a radical salvage job requires power amplifiers for the laser system and extra generators to handle the capacity necessary for the communications and computer systems. During the early part of the 31st century, only Wolf's Dragoons possessed fusion-powered Mobile HQ units, though recovered technology has helped the Mobile HQs proliferate once more.

Notable Crews

Battle Wagon Deuce: One of the original five Wolf's Dragoons Mobile HQ trucks in service, the Deuce became a sort of "holy grail" for the First Chisholm Raiders when they hit Thestria during the last year of the Third Succession War. Realizing that such a prize was a major lynchpin in the Dragoons defense, the Raiders spent the better part of a week tracking down the Deuce through severe terrain and managed to locate it only when a random air patrol caught it in the open attempting to ford the McConnell River. Despite only having a light escort of a lone *Griffin* and three Pegasus scout tanks, the Deuce and its entourage held out against two medium lances of Raiders until Dragoon reinforcements arrived. A lucky shot by a Raider *Quickdraw* snapped the front axle in half, immobilizing it, though the Dragoon command staff still managed to escape the Raider's grasp. The Deuce is still in service and is maintained in as pristine condition as possible—a point of pride for the unit all these years later.

Type: **Mobile HQ**

Technology Base: Inner Sphere

Movement Type: Wheeled

Tonnage: 25

Battle Value: N/A

Weapons and Ammo

Medium Laser

Communications Equipment

Cargo

Location

Turret

Body

Body

Tonnage

1

7

0.5

Equipment

Internal Structure:

Engine: 130

Type: Fusion

Cruising MP: 6

Flank MP: 9

Heat Sinks: 10

Control Equipment: 1.5

Lift Equipment: 0

Power Amplifier: 0

Turret: .5

Armor Factor: 80

Armor Value

Front 16

R/L Side 19/19

Rear 16

Turret 10

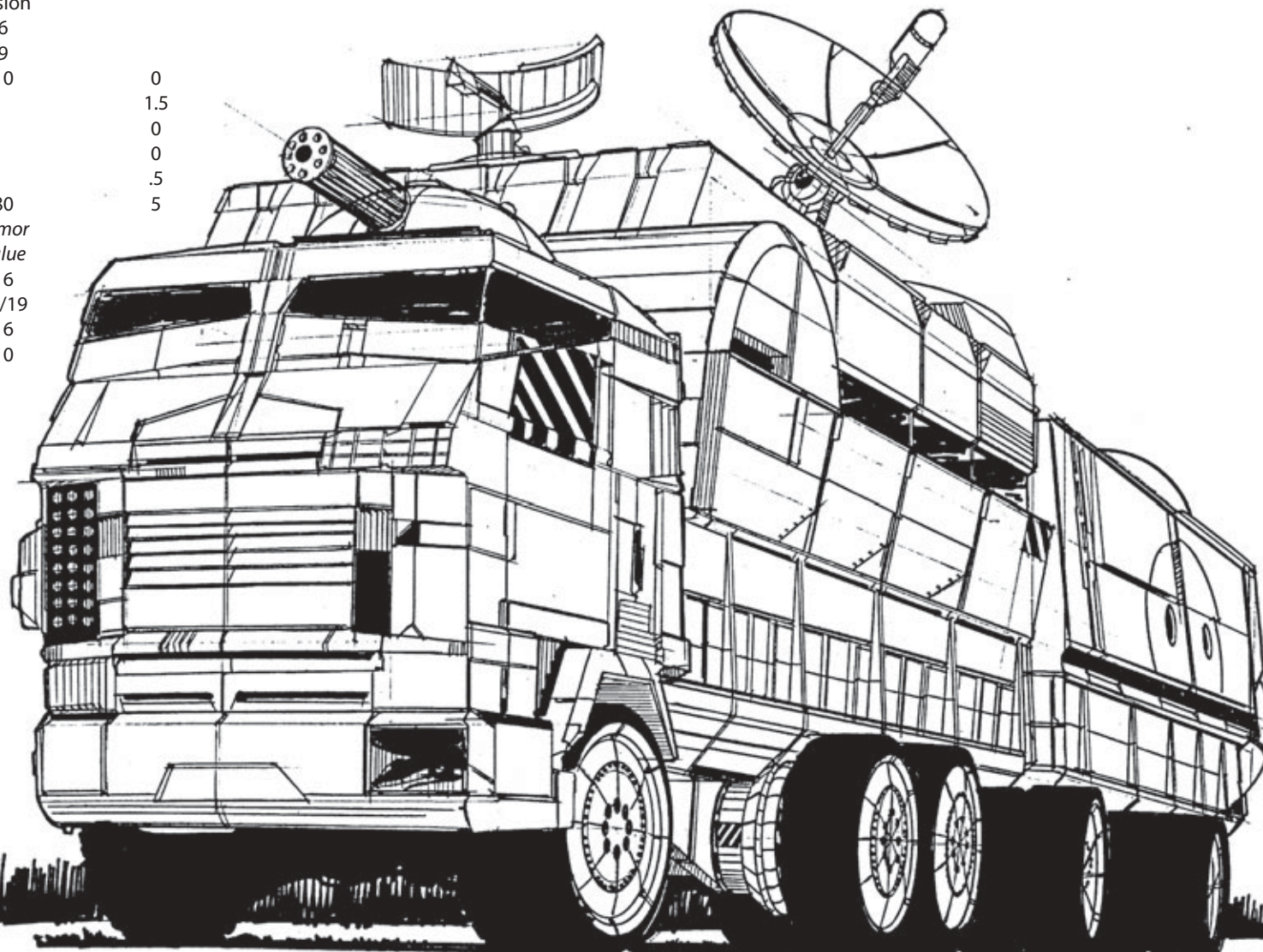

LOOSE

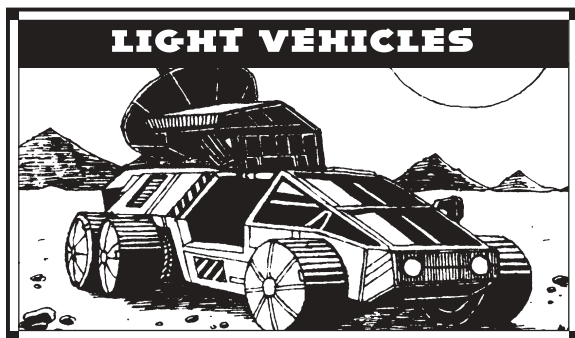

Mass: 25 tons

Movement Type: Tracked

Power Plant: SitiCide 100 ICE

Cruising Speed: 43 kph

Flank Speed: 64 kph

Armor: ProtecTech Light

Armament:

1 Deleon 5 Autocannon/5

1 20mm Gatling Gun Machine Gun

Manufacturer: Quikscell Company, Joint Equipment Systems, Benson and Bjorn, Hellespont Industries

Primary Factory: Pandora, Layover, Kalidasa, Ares (Quikscell), Alshain (JES), Spittal (Benson and Bjorn), Sian (Hellespont)

Communications System: Basix 200

Targeting and Tracking System: OptiSight-12

Overview

The Scorpion Light Tank is another vehicle from the successful Quikscell Company. As is typical with all their products, it is very inexpensive, a fact that has earned the Scorpion the nickname “Budget Tank.” This low cost makes it attractive to buyers from poorer worlds, and field commanders often use the tank in large groups to compensate for its relative weakness in relation to other vehicles.

Capabilities

The Scorpion is not a particularly effective vehicle, though it can fight well enough against other light armor units. The tank is neither particularly fast or well armored—a

dangerous combination in a light armor unit. Its main weapon, the Deleon Autocannon, can inflict marginal damage against targets at fairly long range, but it suffers from tracking problems typical of an autocannon at ranges of less than ninety meters. The 20mm Gatling gun is a time-proven weapon, but it is somewhat lacking when compared to the secondary weapons, like missile racks, commonly carried by other tanks of this weight class.

To compound these shortcomings, the Quikscell Company is notorious for poor quality control. Many new Scorpions suffer a host of minor problems that can be time consuming to identify and correct.

Deployment

Manufactured across the Inner Sphere since its introduction in 2807, the Scorpion remains a common sight in most armies, planetary militia, mercenary commands, and even bandits and pirates.

Bandit kings sometimes become more than a minor nuisance to the Inner Sphere. Whenever one of them becomes too great a threat, House militaries pry loose firepower from duty on other fronts and send an assault force to chastise the self-styled king and persuade them to focus their attention elsewhere (at least for a while). In one such instance, the DCMS mobilized a small ‘Mech force to raid the Santander V system, home of the infamous bandit king Helmar Valasek.

When word of the approaching Kurita force reached Valasek, he devised a plan to deal with the invaders without requiring the sacrifice of any of his own precious ‘Mechs. Valasek had recently “borrowed” several platoons of Scorpion light tanks, which he set up in a supply area he (correctly) anticipated would be the Kuritan target. The moment the Kurita troops touched down, the Scorpions opened fire at close range, dealing heavy damage to the invading ‘Mechs. Because the Kurita ‘Mechs were outnumbered more than three to one and there was nowhere to retreat, the Combine troops went into hand-to-hand (or more accurately, foot-to-turret) combat against the tanks.

Casualties were high on both sides, but when the dust settled, Valasek was able to scavenge some desperately needed ‘Mech parts, and the Kuritans had persuaded

him not to attack their worlds—for the time being. This battle became known as the “Scorpions Nest,” and it is now a popular training exercise for new Kurita MechWarriors, teaching them how to deal with swarms of small vehicles and remain cool in combat.

The Free Rasalhague Republic inherited the Quikscell factory on Spittal from the Draconis Combine. As one of the few native-built armor designs available, the Scorpion was used extensively by the young KungsArmé until the Ghost Bears overran Spittal. The Scorpion’s weaknesses were graphically demonstrated on Radstadt when the *ronin* 603rd Tank Regiment ambushed the First Kavalleri’s armor support. The lack of effective anti-vehicle weapons put the Rasalhague armor at a distinct disadvantage against the *ronin*’s heavier medium tanks. Out of a battalion (predominantly Scorpions), less than a company escaped the carnage.

Variants

A popular variant replaces the autocannon with two SRM 6 launchers and a ton of ammunition. Another version mounts an LRM 10 and LRM 5 launcher, each with a ton of ammunition. A third variant, often pressed into service as a scout or courier, replaces the autocannon with two medium lasers, six heat sinks, power amplifiers, and a ton of cargo space.

Notable Crews

Jalex Schenker and Parson Smith: These two men are owners of the largest independent Scorpion suppliers and repair services in the Inner Sphere. Operating in the Federated Suns near Terra, Schenker and Smith have won all their Scorpions through various games of chance.

Sergeant Klaus Engelbertsson and Korpral Olof Lindh: Like the rest of the Free Rasalhague Republic, the crew of the Scorpion tank “Rosalind” are a cacophonous mix. Klaus Engelbertsson is a former leader of a Mimir resistance cell, while Olof Lindh previously served in the DCMS. Attached to the First Kavalleri regiment, Engelbertsson and Lindh were amongst the handful of tank crews to survive the *ronin* ambush on Radstadt.

SCORPION LIGHT TANK

Type: **Scorpion Light Tank**

Technology Base: Inner Sphere

Movement Type: Tracked

Tonnage: 25

Battle Value: 306

Weapons and Ammo

AC/5

Ammo (AC) 20

Machine Gun

Ammo (MG) 100

Location

Turret

Body

Front

Body

Tonnage

8

1

.5

.5

Equipment

Internal Structure:

Mass

2.5

Engine: 100

6

Type: ICE

Cruising MP: 4

Flank MP: 6

Heat Sinks: 0

0

Control Equipment: 1.5

Lift Equipment: 0

Power Amplifier: 0

Turret: 1

Armor Factor: 64

4

Armor Value

Front 16

R/L Side 11/11

Rear 10

Turret 16

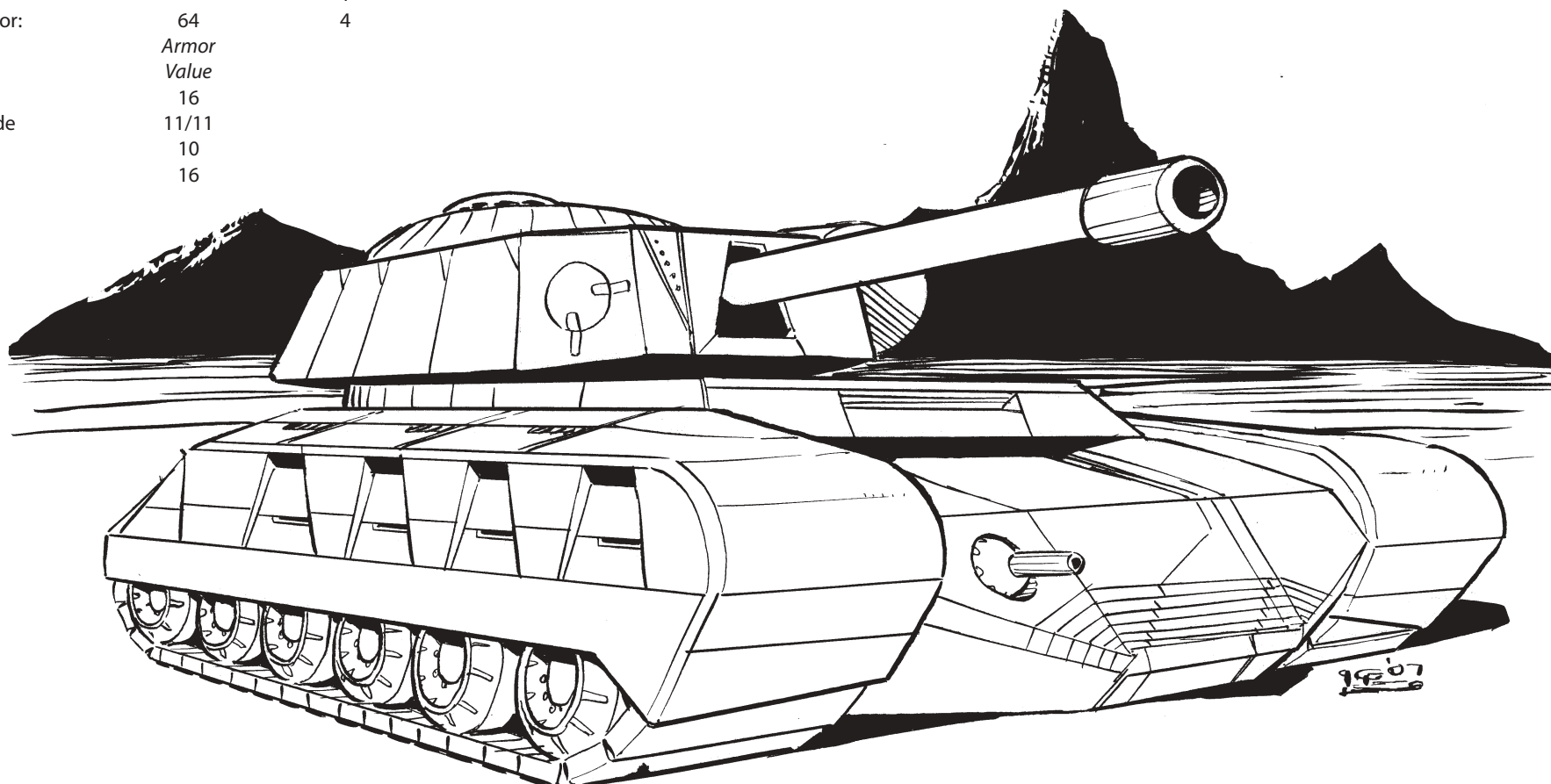

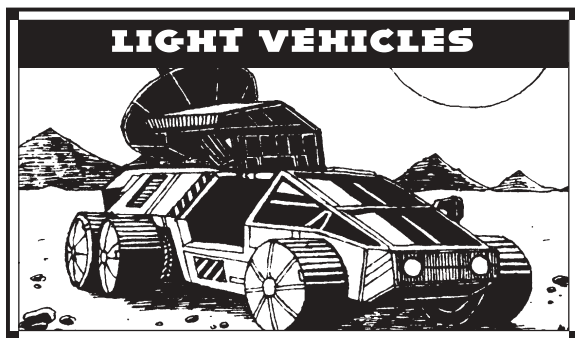

Mass: 25 tons

Movement Type: Naval (Hydrofoil)

Power Plant: Skye Engines 150 Naval ICE

Cruising Speed: 129 kph

Flank Speed: 194 kph

Armor: Glasgow Limited Standard

Armament:

1 Coventry 4 Tube Missile System SRM 4

3 Sperry Browning Machine Guns

Manufacturer: Skye Pleasure Craft, Ltd.

Primary Factory: Skye

Communications System: TharHes Seaweed PG-2

Targeting and Tracking System: TharHes Nav Shark

Overview

The usefulness of the wet navy all but vanished from the Inner Sphere after the Exodus era. Some military missions still remained, however, in systems that had large bodies of water, such as counter-insurgency operations along waterways and the control of civilian shipping on those worlds whose populations were rebellious. To carry out such operations, the military often turned to conventional land hovercraft supplemented by armed commercial vessels rather than expensive, specially designed military ships. In some cases, however, money and titles are thrown around to get “upgraded” technology for less-than-military purposes. On Skye, such “social generalism” actually ended up turning the tide of a Kuritan invasion.

In 2867, a group of young Lyrans of military age approached the LCAF with a proposal: what if they formed their own reserve military unit that was equipped, maintained, and paid for by their own resources? As the Archon had invoked the Military Disaster Act and they expected to be drafted, they sought to avoid becoming cannon fodder by incorporating the unit into the Skye militia, equipped as they saw fit. With pressure from notable Skye families, the LCAF relented and formed the 348th Reserve Detachment. Expecting a lightly armed infantry unit, the LCAF was rather surprised to find the group form themselves around a new vessel design commissioned by the young reservists. Within three months, the 348th could be seen “patrolling” the lakes and rivers around New Glasgow, “escorting” various civilian craft on pleasure trips.

Capabilities

The Sea Skimmer was faster and more heavily armored than the LCAF’s standard Silverfin cutters. Because the initial development and production was limited to the 348th, the design did not spread to other LCAF units until after the Kuritan invasion in 2895. Due to the heroic actions of the reserve unit’s Skimmers, the LCAF formally contracted the design from Skye Pleasure Craft and delivered many to Lyran border worlds.

Armed with a turret-mounted SRM 4 and powerful Sperry-Browning machine guns covering the sides and rear, the Sea Skimmer can outrun most other armed naval vessels in production. The LCAF has, from time to time, researched possibilities in modifying a DropShip design to combat-load and -offload swarms of Skimmers, but nothing has come to fruition.

Deployment

After its inception, the 348th kept Skye “free from Combine oppression” despite the fact that the Combine was nowhere near Skye at the time. Though the unit would assemble at a local yacht club, appropriate “supplies” and “civilian observers” to execute “maneuvers” several times a month, the unit saw no action until the Combine invaded in 2895.

After a battalion of Kuritan ‘Mechs broke through the lines and advanced over the floodplains and threatened Inverness, the Skye defenders had nothing left to stop them. The commander of the Inverness garrison made an unorthodox decision that contradicted the unwritten rules of warfare of the time. He decided to use one-kiloton nuclear “demolition” devices to bring down the Mantty River Dam behind the Combine lines. He sent the lone two Sea Skimmers, each with a nuclear device, from the 348th to carry out what was obviously a suicide mission.

The crews of both vessels embraced their Lyran duty wholeheartedly. Racing past most Kuritan forces, the last of the 348th were intercepted by a pair of scout mechs and the Kuritan infantry on the dam. The two Skimmers toppled a *Wasp* with SRM salvos and sought to bypass the other, only to have the *Wasp* sit up as one of the Skimmers raced over the submerged ‘Mech. The collision crippled that Skimmer, but the remaining Sea Skimmer reached the dam and detonated the device, flooding the Combine lines. The Kuritans withdrew less than a week later.

Variants

Though no official variants exist through Skye Pleasure Craft, some militias have done some unofficial modifications due to technology breakdowns and a lack of spare parts. Some of these modifications include stripping out the machine guns and replacing them either with an additional SRM 2 launcher, or upgrading the SRM 4 to a SRM 6.

Notable Crews

Tiger Lily: The lone Sea Skimmer assigned to the Kandis Militia, the Tiger Lily was responsible for maintaining Duke Kelswa Steiner’s unauthorized rebellion during the formation of the Free Rasalhague Republic. The crew assisted the Dragonslayers mercenary unit for several weeks, pinpointing coastal targets along the Tiberian River until the craft was destroyed by a scout lance from the First Shin Legion. The wreck remains at the bottom of the river surprisingly intact and has become a popular dive spot for vacationers.

SEA SKIMMER HYDROFOIL

Type: **Sea Skimmer Hydrofoil**

Technology Base: Inner Sphere

Movement Type: Naval (Hydrofoil)

Tonnage: 25

Battle Value: 281

Equipment

Internal Structure:

Engine: 150

Type: ICE

Cruising MP: 12

Flank MP: 18

Heat Sinks: 0

Control Equipment: 1.5

Lift Equipment: 2.5

Power Amplifier: 0

Turret: .5

Armor Factor: 32

Armor Value

Front 9

R/L Side 7/7

Rear 4

Turret 5

Weapons and Ammo

SRM 4 Turret

Ammo (SRM) 25 Body

Machine Gun Left

Machine Gun Right

Machine Gun Rear

Ammo (MG) 100 Body

Mass

2.5

11

0

1.5

2.5

0

.5

2

Tonnage

2

1

.5

.5

.5

.5

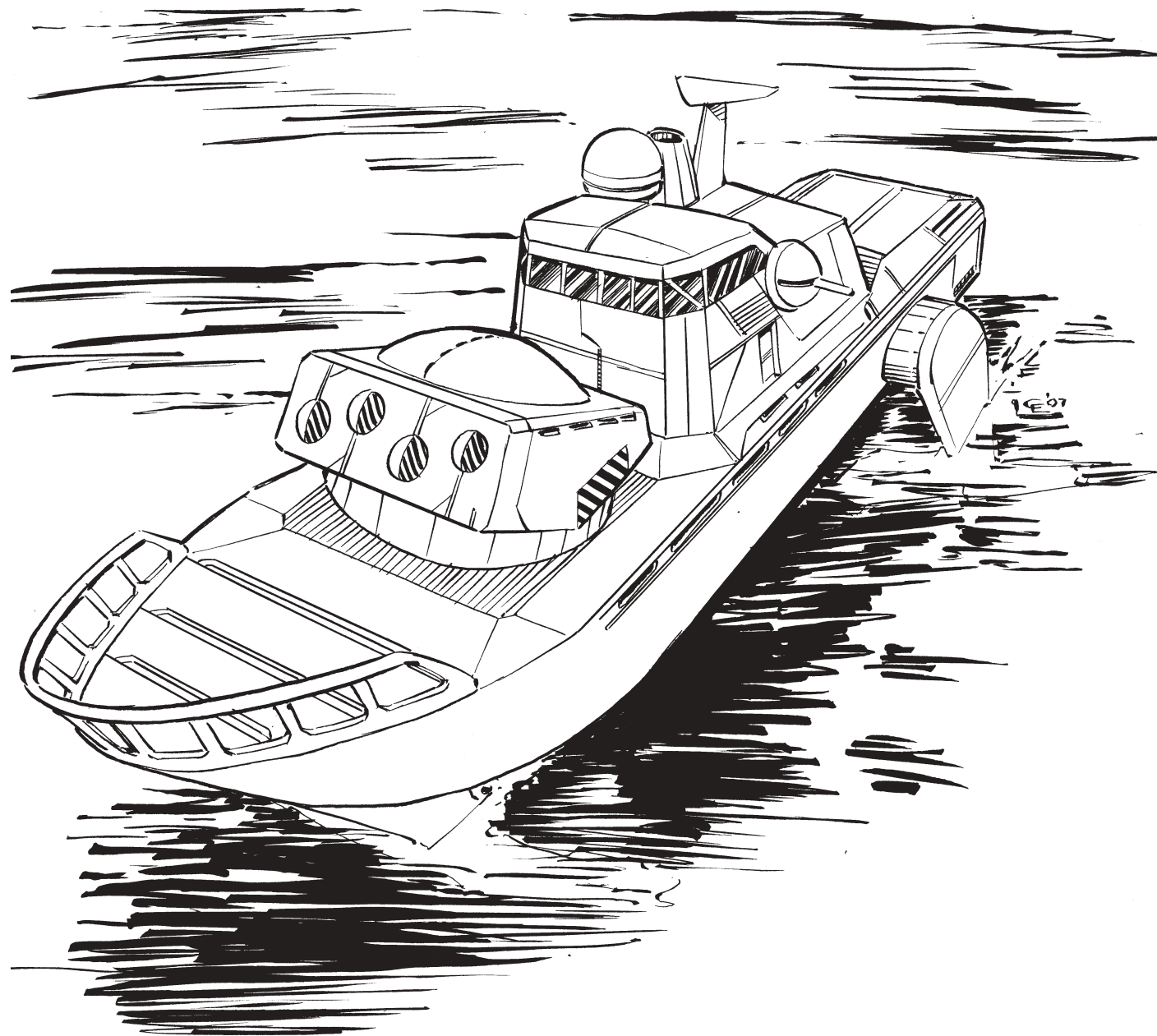

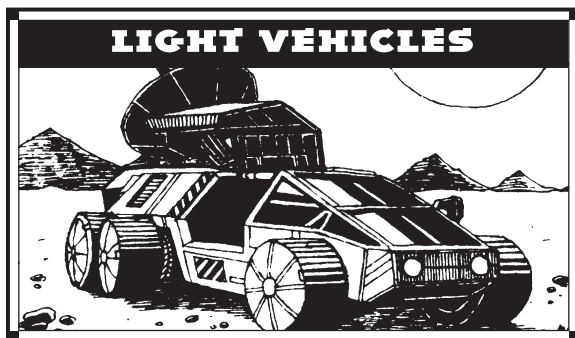

Mass: 30 tons

Movement Type: Wheeled

Power Plant: Tamia 100 ICE

Cruising Speed: 43 kph

Flank Speed: 64 kph

Armor: StarSlab/3

Armament:

2 Dragon's Breath Flamers

Manufacturer: Buda Imperial Vehicles

Primary Factory: Luthien

Communications System: Sipher CommSys 1

Targeting and Tracking System: Matabushi Sentinel

Overview

The first coolant trucks appeared on the battlefield in 2583 during the Reunification War. The siege of Cerberus, a desert world in the Outworlds Alliance, was proving difficult. The SLDF lost several battles simply because the Periphery armies were able to force the superior Terran Hegemony-built 'Mechs to shut down through overheating with unrelenting attacks. The introduction of coolant trucks extended the endurance of the SLDF BattleMech forces, and Cerberus fell at last.

Built for the Draconis Combine by Buda Imperial Vehicles, the Class 135-K coolant truck (code-named "The Lifesaver") is a typical example of such a unit.

Capabilities

Coolant trucks, better known as "coolers" among MechWarriors, station themselves close to the battlefield and at field repair areas, where they can be hooked up to overheated 'Mechs and flush away excess heat with chilled coolants. The Lifesaver uses armored cryogenic tanks to carry over five tons of liquid nitrogen and two tons of liquid oxygen, taking advantage of the high heat capacity of water-based coolants for super-cold temperatures. Motors stir the contents to prevent dangerous temperature gradients that might rupture the tanks.

The vehicle is armed with two turret-mounted Dragon's Breath flamers. These weapons have a unique feature; when approached by a friendly 'Mech that has been targeted by inferno rounds or is overheating dangerously, the flamers can discharge liquid nitrogen. This douses the flames and cools the 'Mech off in a cloud of supercool mist.

The liquid oxygen is used to replenish a 'Mech's environmental systems and cool a BattleMech if the liquid nitrogen is exhausted. The Lifesaver also uses the liquid oxygen to enrich its flamer fuel, making it burn hotter.

The Lifesaver has five receptacles for the long hoses used for attachment to overheating 'Mechs. The first four dispense liquid nitrogen, while the fifth contains liquid oxygen. Light and medium 'Mechs have just one hook-up point, but heavy and assault 'Mechs require two for cooling.

Deployment

Today, coolant trucks form part of the maintenance and support echelon, where they fall under the command of the Master Tech. A single, well-maintained regimental battle group will usually field about six coolers.

Deployed to slowly follow an advance or move just behind a defensive line, coolant trucks and their six-man crews (consisting of a driver, a gunner, and four hose-men) sometimes face enemy fire. Assignment to a cooler team is not particularly popular, yet the better teams take a certain pride in their work. MechWarriors often call them "ice men" for their stoical behavior in carrying out their work as

the battle swirls around them. Coolant trucks are valued as prizes (as well as important strategic targets). If a cooler and its team are captured intact, it is not unusual for them to be offered a chance to work for their captors. Mercenary units are always on the lookout for seasoned cooler teams and have been known to offer them a share of the unit's booty equal to what two Techs would earn.

'Mechs are especially vulnerable when hooked up to a cooler. During the Succession Wars a battlefield etiquette evolved, which extended special 'courtesy' to a cooler-hooked 'Mech. The enemy would usually ignore a 'Mech that was hooked to a cooler, as long as it did not shoot. Once the 'Mech had disconnected and moved a few meters away from the trucks, it became fair game once more. Recently, however, there have been signs that such battlefield courtesies are falling by the wayside.

Variants

Many types of coolant trucks exist. Some are hovercraft and others are tracked vehicles. Most variations are a matter of alternate coolants, often selected to match the coolant used by the heat sinks of friendly BattleMechs.

Notable Crews

Cooler Team Five: Commanded by *Gunsho* Jerry Nakamura, the "ice men" of Cooler Team Five serve with the Fourteenth Legion of Vega. As is to be expected for troops serving in the command once referred to as "the armpit of the Dragon," they are a motley collection of troublemakers, crooks, and misfits.

When overwhelming Lyran forces attacked Vega in 3039, the Fourteenth relied heavily on its cooler teams to hold on until the Second Legion could arrive and eject the invaders. Time and again, Cooler Team Five braved enemy fire in the searing Vega summer to keep the Legion's *Dragons* and *Panthers* in the battle.

COOLANT TRUCK

Type: **Class 135-K "Lifesaver" Coolant Truck**

Technology Base: Inner Sphere

Movement Type: Wheeled

Tonnage: 30

Battle Value: 321

Equipment

Internal Structure:

Engine: 100

Type: ICE

Cruising MP: 4

Flank MP: 6

Heat Sinks: 0

Control Equipment: 1.5

Lift Equipment: 0

Power Amplifier: 0

Turret: .5

Armor Factor: 112

Armor Value

Front 24

R/L Side 28/28

Rear 20

Turret 12

Weapons and Ammo

2 Flamers (Vehicle)

Ammo (Flamer) 40

Cargo, Insulated

(5.655 tons LN₂)

Cargo, Insulated

(2.175 tons LOX)

Location

Turret 1

Body 2

Body 6.5

Body 2.5

Tonnage

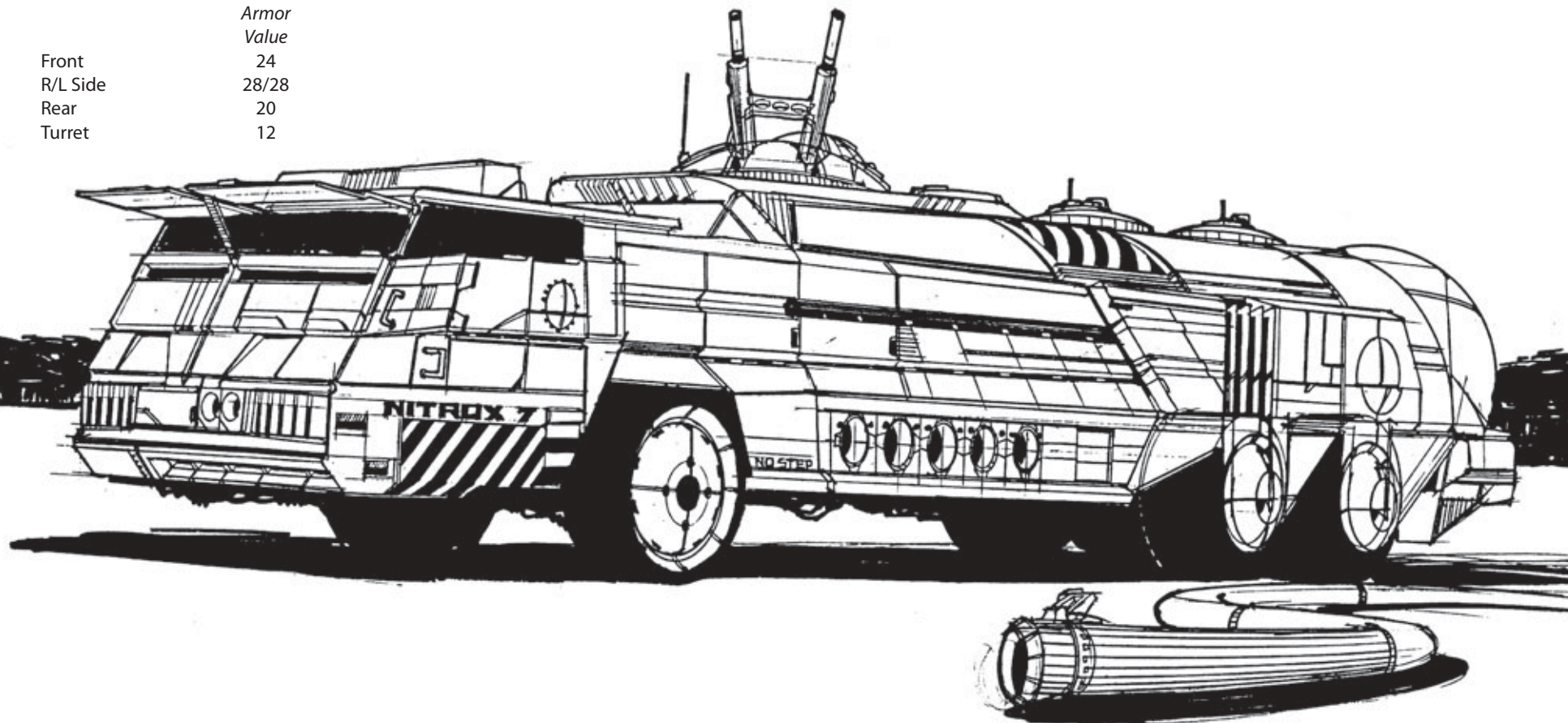

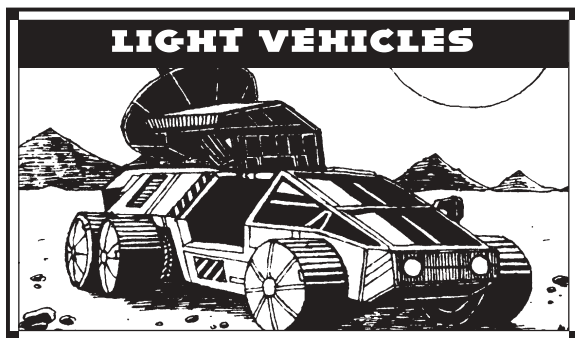

Mass: 30 tons

Movement Type: VTOL

Power Plant: DAV 190 ICE

Cruising Speed: 119 kph

Flank Speed: 184 kph

Armor: StarSlab/1.5

Armament:

None

Manufacturer: New Earth Trading Company

Primary Factory: Terra

Communications System: Johnston Q-Rotor

Targeting and Tracking System: None

Overview

The Karnov UR Transport is a heavy lift VTOL. It is no longer known when the Karnov first entered service, but most experts believe it is a Terran design hundreds of years old. Equally puzzling is the fact that though the Karnov is currently sold by the New Earth Trading Company, NETC has no known VTOL production facilities, and no other firm has admitted to producing the Karnov on a sub-contractual basis. It is now well over a century since New Earth first began to offer new Karnovs for sale. Regardless of how the manufacturing process works, NETC sales representatives diligently take orders, and Karnovs reliably arrive on the next NETC DropShip.

The Karnov has proven to be a reliable and hardy machine, whatever its origin. It is not uncommon to find several in service to both military and corporate concerns on nearly every civilized planet within the Inner Sphere. It is equally versatile in roles as a cargo carrier and a flying crane.

Capabilities

The central wing spar and struts are built around the DAV 190 ICE aircraft engine, known for its reliability and ruggedness. The DAV connects by drive shafts that extend down the wing pylons to the twin rotor assemblies. The pylons are capable of a ninety-degree tilt, which allows the Karnov UR horizontal speeds over 180 kph. The speed comes with cost, however; the blades are so large they have to be rotated to a vertical position upon landing or they will strike the ground. Many new pilots forget this simple but important rule, leaving not only a wreckage of the expensive VTOL but also the remains of their career.

The Karnov also mounts variable landing gear; when at full extension it can straddle a load up to 3.3 meters tall. When completely collapsed, the interior cargo bay ramp can be fully extended to allow cargo loading and unloading. The StarSlab armor forged specifically for the Karnov gives it decent protection against infantry and small-arms fire for hot LZs; however, the overly large rotors make excellent targets for better-armed opponents. Many crashed Karnovs can be seen on a battlefield with fuselage and wing struts intact but the delicate rotors completely shot away.

Deployment

Because its primary role is as a transport vehicle (though armored for fast battlefield insertions and fitted with independent cargo handling features typical of military transports), the Karnov UR is not designed for frontline combat duties. It is slow when fully laden and lacks weaponry for defense. With its vulnerable rotors, the Karnov is a sitting duck for any decently armed combat unit. Despite this, however, some mercenary and “kamikaze” combat logistic groups have managed to make a name for themselves using the Karnov.

Variants

NETC does not offer variant models of the Karnov. In fact, the basic design of the VTOL has not changed in any detail since NETC started supplying the Karnov over 120 years ago. In most cases, variants are made in the field as battlefield conditions and owners dictate. A common upgrade that made the rounds during the War of 3039 is a “gunship” version that mounted two Sperry-Browning machine guns in each arc. Rumors periodically circulate of a variant mounting a single heavy weapon such as an autocannon/20 or artillery gun in the side of a Karnov; however, no confirmed sighting exists.

A rare version mounts special baffles on the rotors and engine nacelles, creating an ultra-quiet stealth version. This variant has been known to be in use with the DEST and Loki, as it was reported to be used by both groups in various Ronin War incidents.

Notable Crews

Dagger-T: The only publicly acknowledged stealth Karnov in use with Loki forces, the Dagger-T holds a special place in the history of Blackjack in the Lyran Commonwealth. During a hostile corporate takeover that went horribly wrong, the locally assigned Loki team made a high-atmosphere insertion using the modified Karnov. Launched from a suborbital DropShip (the terrorists were monitoring all local air traffic and had demanded all craft be grounded at the time), the Dagger-T and her crew managed to not only survive the high atmospheric release in a controlled dive but also managed to deliver the Fast Response Team on target. With the advantage of total surprise, the Loki FRT managed to save all 173 of the hostages and eliminate the eight terrorists hired by a rival company. The Dagger-T now sits on temporary display on the Blackjack SWAT Academy grounds.

KARNOV UR TRANSPORT

Type: **Karnov UR Transport**
 Technology Base: Inner Sphere
 Movement Type: VTOL
 Tonnage: 30
 Battle Value: 120

Equipment		Mass
Internal Structure:		3
Engine:	190	15
Type:	ICE	
Cruising MP:	11	
Flank MP:	17	
Heat Sinks:	0	0
Control Equipment:		1.5
Lift Equipment:		3
Power Amplifier:		0
Turret:		0

Equipment		Mass
Armor Factor:	24	1.5
	<i>Armor Value</i>	
Front	6	
R/L Side	5/5	
Rear	6	
Rotor	2	

Weapons and Ammo	Location	Tonnage
Cargo	Body	6

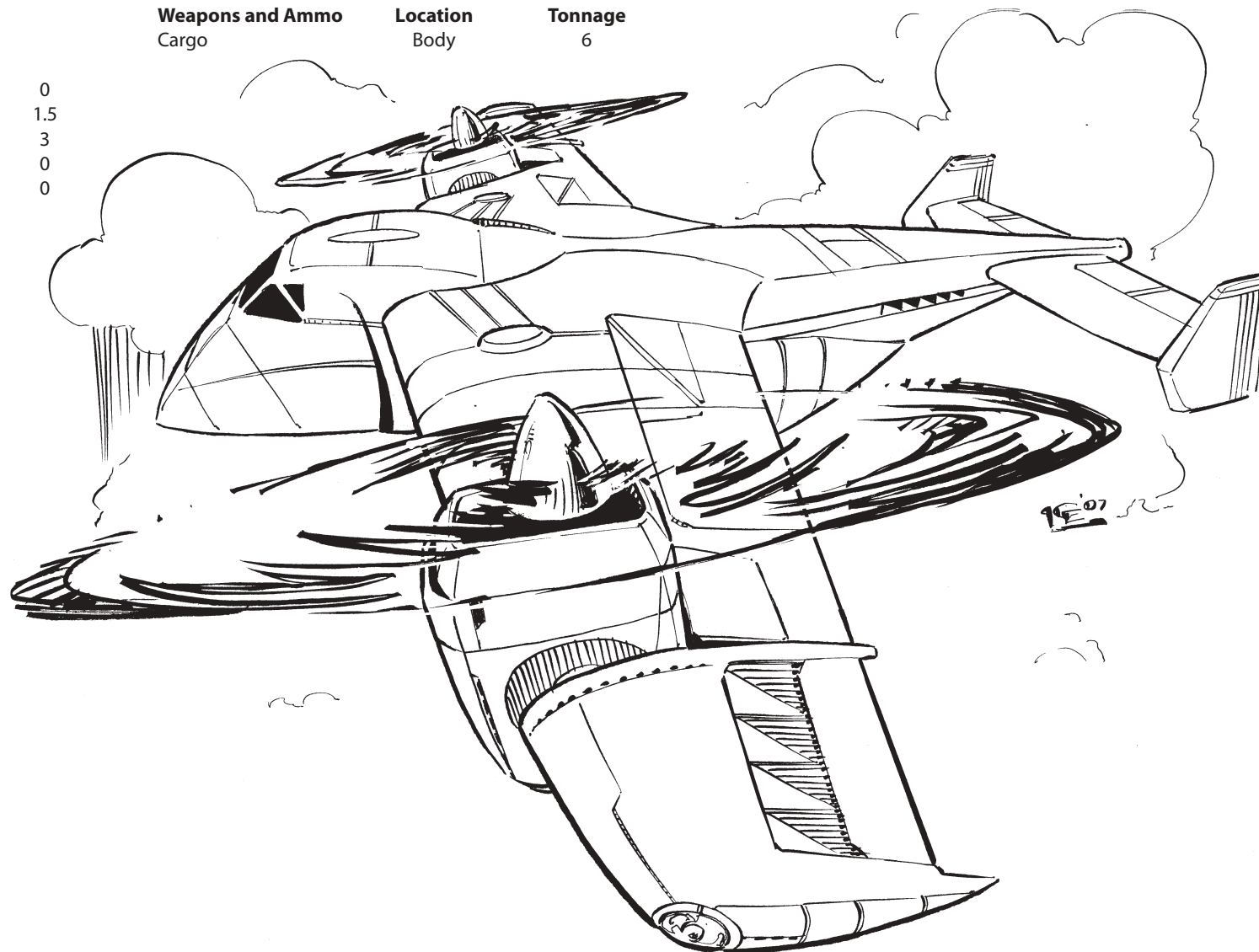

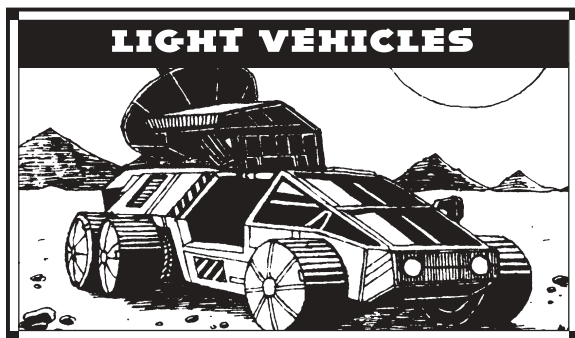

Mass: 35 tons

Movement Type: Tracked

Power Plant: Magna 175 Fusion

Cruising Speed: 54 kph

Flank Speed: 86 kph

Armor: StarSlab/5.5

Armament:

1 FarFire Maxi-Rack LRM 20

1 Zippo Flamer

Manufacturer: Defiance Industries

Primary Factory: Hesperus II

Communications System: TharHes Mini-Talk

Targeting and Tracking System: TharHes AGART

Overview

Produced by Defiance Industries of Hesperus II, the Hunter Light Support Tank is both inexpensive and well-suited to its battlefield role. This makes it very popular with the planetary militias and under-funded second-line units that have the support capabilities for fusion engines. As a support unit, the Hunter does not need high speed and maneuverability, but it is still moderately swift by tracked standards. Its low profile and twenty-tube FarFire Maxi-Rack long-range missile launcher allows the tank to exploit sheltering terrain and supply indirect fire support.

Capabilities

With two tons of long-range missiles to feed its twenty-tube launcher, the Hunter can be an extremely effective support vehicle. Given the FarFire's long history of reliability mounted on a variety of vehicles, this is hardly surprising. The rack is mounted toward the rear of the vehicle, facing forward, to enable the Hunter to fire over defensive barriers without exposing itself to enemy fire.

The Hunter's second weapon is perhaps the only flaw in the tank's design. A rear-facing anti-personnel flamer, it is seldom used directly against attackers. More commonly, tank crews start brush fires in hopes the resultant smoke and heat will confuse pursuers. Stories of Hunter crews using the flamer as an outdoor barbeque are probably untrue; the plasma weapon is ill suited for producing gentle grilling heat. Given that the FarFire's extreme range usually keeps Hunters far from the center of battle, some question the utility of a close-defense anti-personnel weapon.

The TharHes Mini-Talk communications system and the TharHes AGART targeting computer, both standards of Defiance Industries' electronics division, are more robust than systems usually found in support tanks. The original design called for the Hunter to be equipped with more economical systems, but technical problems convinced Defiance engineers that the monetary savings of cutting corners did not justify the degraded performance in combat.

Deployment

The Hunter had a rocky introduction. Military thinking of the period dictated that a tank be able to stand up under heavy fire and deliver a wide variety of ordnance, so customers were not expecting Defiance to produce a specialized, light support tank—let alone put a fusion engine on a fire-support tank during the tech-starved days of the Succession Wars. On paper and in the proving trials, there was little about the Hunter to attract the attention of procurement officers. It was not until planetary militias demonstrated its effectiveness in combat that commanders in the major militaries came to appreciate the Defiance design. Today examples of the Hunter Light Support Tank can be found throughout the Inner Sphere.

Variants

The well-designed and executed Hunter does not lend itself to modification. Any variants are locally produced and usually involve replacing the LRM 20 with a ten- or fifteen-tube launcher and devoting the freed weight and space to close-defense weapons, thus reducing the Hunter's effectiveness as a fire-support platform. None of these ad hoc variants have been subjected to thorough, independent evaluation. Stripping the tank of the flamer and devoting the freed space to another ton of missiles makes a certain sense, but transferring the missiles from the awkward location to the launcher presents problems that have never been addressed to everyone's satisfaction.

Notable Crews

First Kittery Planetary Armored Militia: Contrary to accepted history, the last Capellan force to stand against the Davion conquest of Kittery in 3005 was not the Second St. Ives Lancers. Once the decision had been made to pull the "elastic defense" of the Confederation back to Vestallas and Taga, the Lancers faced a tactical dilemma. The invaders were bent on destroying the Capellan military and could not be trusted to honor a peaceful withdrawal should the Lancers formally yield the planet.

The eventual solution was suggested by the leader of the Kittery Planetary Militia. Because neither she nor anyone in her command had any intention of leaving their home world, they would delay the Davion forces and cover the Lancer departure. Using the sniper tactic of "shoot and scoot," the Kittery tank corps—two companies of medium and light tanks, nine of which were Hunters—engaged the enemy along a ragged and shifting front. Turned to meet what they thought was a flanking assault, the Federated Suns force was out of position when the Lancers made their break for freedom.

Since members of the Kittery Planetary Militia became the backbone of the Kittery Tong resistance, all records of their names and whereabouts were purged to protect them and their families from potential reprisals by the Federated Suns occupation force.

HUNTER LIGHT SUPPORT TANK

Type: **Hunter Light Support Tank**
 Technology Base: Inner Sphere
 Movement Type: Tracked
 Tonnage: 35
 Battle Value: 648

Weapons and Ammo	Location	Tonnage
LRM 20	Front	10
Ammo (LRM) 12	Body	2
Flamer	Rear	1

Equipment		Mass
Internal Structure:		3.5
Engine:	175	10.5
Type:	Fusion	
Cruising MP:	5	
Flank MP:	8	
Heat Sinks:	10	0
Control Equipment:		2
Lift Equipment:		0
Power Amplifier:		0
Turret:		0
Armor Factor:	96	6
	<i>Armor Value</i>	
Front	32	
R/L Side	24/24	
Rear	16	

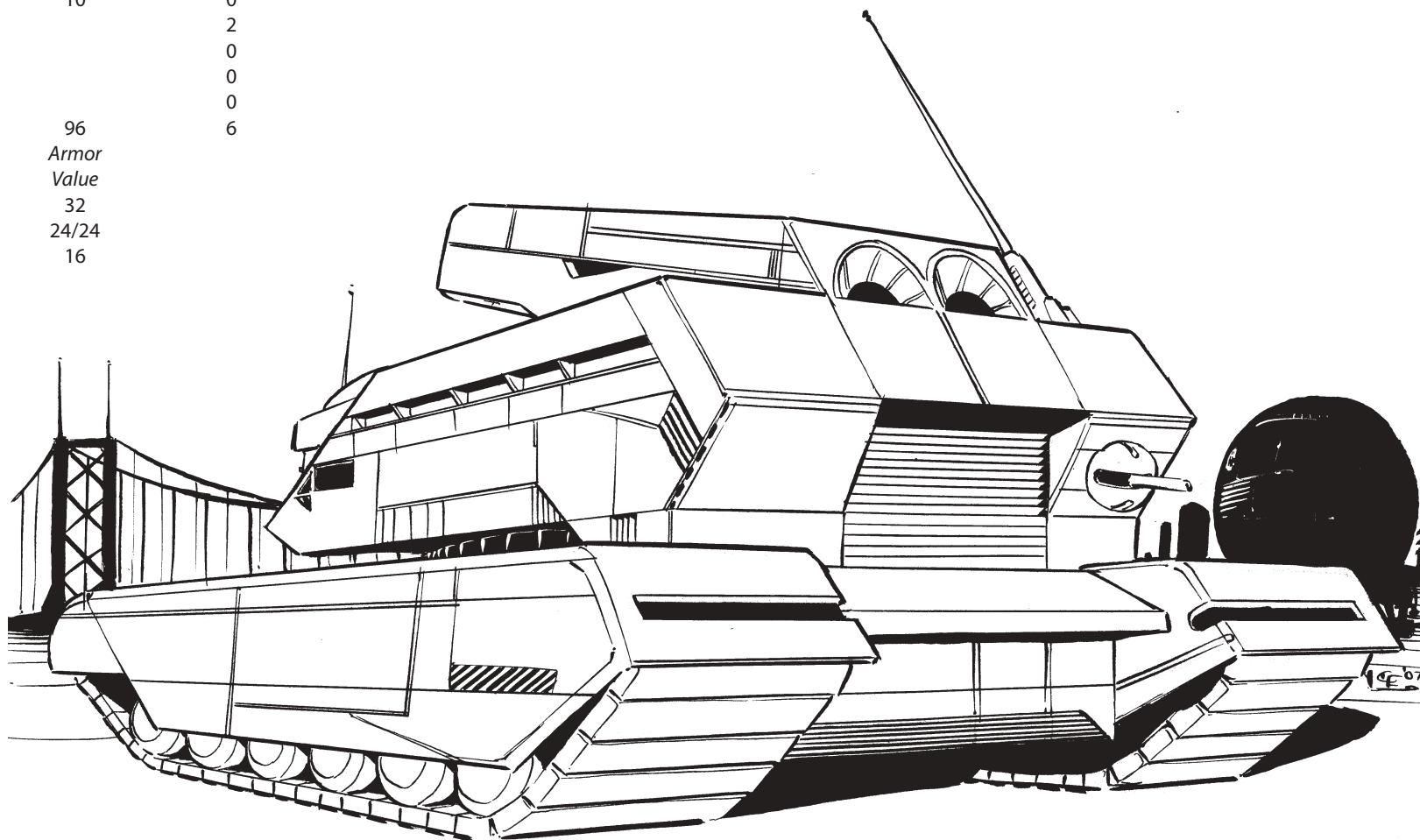

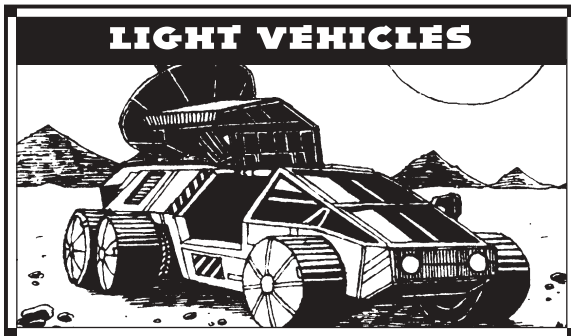

Mass: 35 tons

Movement Type: Hover

Power Plant: GM 105 ICE

Cruising Speed: 86 kph

Flank Speed: 129 kph

Armor: ProtecTech 6

Armament:

2 StarStreak Heavy SRM 6 Racks

1 Defiance B3M Medium Laser (Exeter and Red Devil), Diverse Optics Type 2 Medium Laser (Hellespont)

Manufacturer: Exeter Organization, Red Devil Industries, Hellespont Industries

Primary Factory: Keystone (Exeter), Pandora (Red Devil), Sian (Hellespont)

Communications System: Exeter LongScan with ReconLock

Targeting and Tracking System: Salamander Systems CommPhase Unit

Overview

The Pegasus first made its appearance as an inexpensive recon unit during the First Succession War, when that vicious conflict forced the Houses to redirect scout BattleMechs to frontline duty. The Pegasus is unusual amongst scout vehicles for the breadth of its user base. Unlike many nation-specific designs, the Pegasus is used

by virtually every major military organization. This proliferation is due to a successful licensing deal between the original manufacturer, the Exeter Organization, and Red Devil Industries of Pandora, in which Red Devil traded a license to build the reliable Defiance B3M laser (and quite a bit of money) for the license to build the Pegasus. The illegal copies produced by Hellespont Industries of Sian also keep Pegasi plentiful.

Capabilities

Often described as a “Harasser on Steroids,” the Pegasus carries much of the same armament in the form of a pair of turret-mounted SRM 6 racks for its main offensive and defensive armament. In its front is a single medium laser that, though inefficient for its weight on this internal combustion vehicle, allows the Pegasus to operate behind enemy lines even after its missiles run dry.

The Pegasus is reasonably well armored for a hover tank of its size, with six-and-a-half tons of ProtecTech on its frame. Though crews are trained to avoid enemy contact as much as possible, the armor has allowed the tank to survive several lucky large laser hits to any location. Unless hiding from enemy patrols, the Pegasus moves at a respectable top speed of nearly 130 kph.

The main feature of the Pegasus is not its combat systems but its electronics suite. Its targeting system allows the computer to scan and select targets that are the easiest to hit, automatically firing off its laser and missiles unless the human gunner overrides. This is the closest thing to an artificial intelligence that the Inner Sphere has allowed since the Amaris Civil War, as even in modern days many still fear automated systems being turned against them.

Unlike most other reconnaissance units, the Pegasus has no capability to communicate with units in orbit or further away. Units must purchase and install an additional Exeter-built transmitter, called TransBoost, for such abilities. This is a tight-beam microwave system allowing for secure, long-range communications. Many customers complained of the need to purchase separate equipment to give the Pegasus the same capabilities as other scout tanks, to which Exeter responded by offering pre-installed TransBoost units in 3027 (for a nominal fee).

Deployment

Exeter has attempted several times to serve cease-and-desist orders to Hellespont Industries on Sian for reproducing the Pegasus without permission, but both the current and previous Chancellors have blocked diplomatic missives and court actions alike. Hellespont has been selling to the Capellan Confederation at cut rates (with the TransBoost), which explains the blatant protectionism by a realm in desperate need of any and all military equipment.

Red Devil’s production line continued to operate at full capacity for the newly created Federated Commonwealth. However, lack of funds for upkeep or maintenance has begun to take its toll on the production line. Red Devil continued this jury-rigged maintenance policy in the face of the Clan menace; ironically, Pandora would fall to the Jade Falcons in 3064, a mere two years after the facility was finally upgraded.

Scarborough Manufacturing of Al Na’ir also produces a version of the Pegasus, though it lacks the sophisticated electronics—Exeter refused to license these in protest of Scarborough’s avoidance of FWL import taxes.

Variants

Most Pegasi are modified solely to the crew’s tastes, often expanding on the internal compartments for increased comfort or stripping out weaponry for better sensors. Those that remove the weapons believe they are less likely to be fired at since their vehicle is unarmed. A few crews have expressed interest in removing the medium laser and heat sinks for more missiles, but none have been spotted to date.

Notable Crews

Kenneth Long: Despite losing six crewmembers and three Pegasi in the last six years, Kenneth Long continues to believe that his unarmed Pegasi, all nicknamed “The Dove,” are safe havens because they are unarmed, and that arming The Doves would draw even more attacks. His surviving crewmates, however, think this is folly, as they find themselves being attacked by vehicles that would otherwise be scared to engage the scout tank, such as the Ferret VTOL that was credited with the latest kill of one of the Doves.

PEGASUS SCOUT HOVER TANK

Type: Pegasus Scout Tank

Technology Base: Inner Sphere

Movement Type: Hover

Tonnage: 35

Battle Value: 640

Weapons and Ammo

2 SRM 6

Medium Laser

Ammo (SRM) 15

Cargo

Location

Turret

Front

Body

Body

Tonnage

6

1

1

.4

Equipment

Internal Structure:

Engine: 105

Type: ICE

Cruising MP: 8

Flank MP: 12

Heat Sinks: 3

Control Equipment:

Lift Equipment: 3.5

Power Amplifier: .1

Turret: 1

Armor Factor: 104

Armor Value

Front 21

R/L Side 19/19

Rear 19

Turret 21

Mass

3.5

7

3

2

3.5

.1

1

6.5

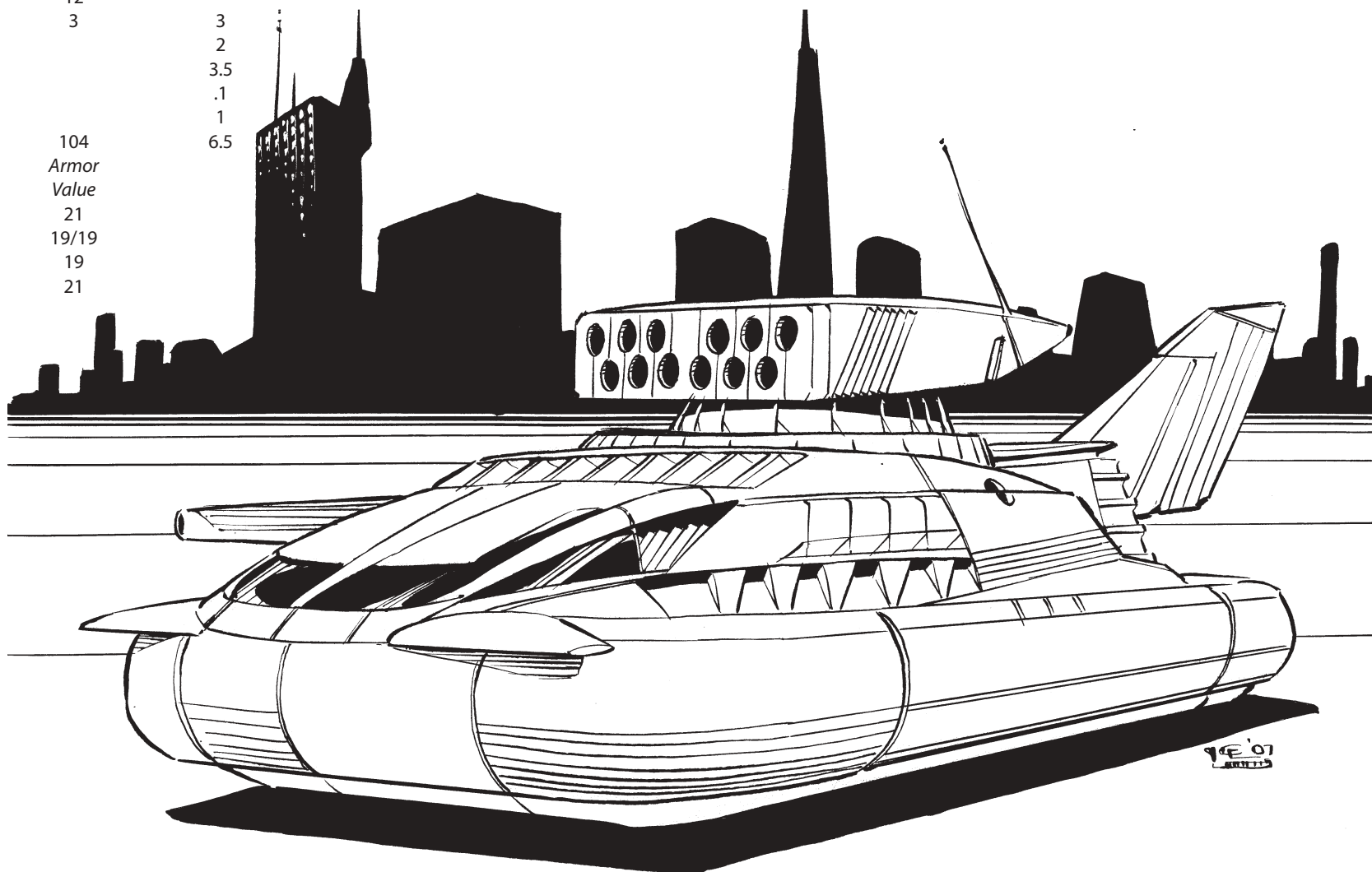

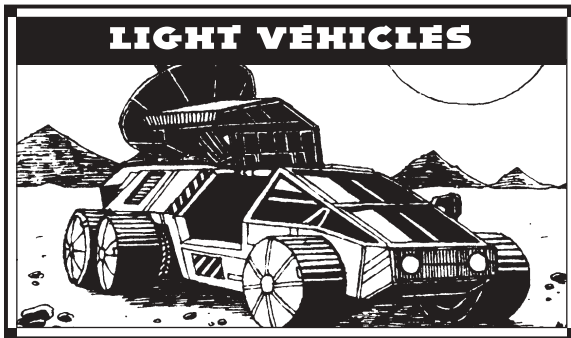

Mass: 35 tons

Movement Type: Hover

Power Plant: ConLee 105 ICE

Cruising Speed: 86 kph

Flank Speed: 129 kph

Armor: ProtecTech 4

Armament:

1 Scarborough Original 20 Autocannon/20

Manufacturer: Scarborough, Ltd.

Primary Factory: Al Na'ir

Communications System: Scarborough Talky-2

Targeting and Tracking System: Scarborough
Assault-1

Overview

Successful sales of the Scimitar and Saracen led Scarborough to create a third hover tank off the same chassis. Rather than adhere to the basic design as closely as they had with the other two, the Saladin removed the turret entirely and was designed mainly for defensive operations where ammunition and repair facilities were near. Consumers were hoping for something to supersede rather than compliment the other Scarborough offerings, but initial sales were sluggish. Undaunted and knowing they had a good product, the company offered free shipping and training for the Saladin. These incentives and battlefield successes helped the Saladin sell almost as well as the Saracen.

Capabilities

To quote the vid sensation *Azami Warriors IV*, the Saladin “moves fast and blows [things] up!” While a top speed of nearly 130 kph is somewhat average for a hovercraft, it is probably the fastest thing without wings sporting a class 20 autocannon. Few ‘Mechs can outrun the Saladin, nor can many wheeled or tracked armored units. A functional if not exceptional weapon, the Scarborough Original 20 can destroy most combat units smaller than the Saladin in one shot and can cripple units much larger. In fact, the mere presence of the Saladin can influence the battle, as smaller units look to stay out of the way of the craft’s vicious gun. Designers also made sure that the Saladin could afford to take some riskier shots at high speed by giving it three tons of ammunition.

Despite its assets, the Saladin has some drawbacks. The most obvious is the lack of armor. Half of the vehicle’s weight is spent on its main gun and ammo, but less than five percent is used to protect the valuable craft. Scarborough understood the compromise required to mount the massive weapon and spread the minimal armor accordingly: thick on the front and minimal elsewhere. Secondary concerns (compared to the armor deficiency) were the lack of a turret and supporting weapons, a situation forced by the weight demands of the autocannon.

Deployment

While produced in the Draconis Combine, the Saladin is frequently exported, often via a “shell company” licensing agreement with the Free Worlds League. A rather large percentage have been purchased by Periphery nations seeking a unit with a heavy punch but speed to deal with fast-moving bandits or pirates. An anomaly in Saladin sales was the relatively high number of Scarborough hovercraft that the Combine allowed to be sold to the Lyran Commonwealth, a traditional enemy. Since the merger of this realm with the Federated Suns, however, sales have declined drastically. In the Combine, most of these units can be found on the Azami worlds, where the oft-barren terrain allows for ideal deployment of the Saladin, and the name of the tank is venerated by the locals.

Variants

With the limited size of the Saladin and its structure, there are very few variants and none from Scarborough. Most buyers would be better off purchasing one of Scarborough’s other tanks built on the same chassis. Despite the glaring need for more armor, the Saladin has yet to see any attempts to use advanced forms of armor or structure, nor is Scarborough high on the Combine’s priority list. Some crews, desperate for more protection, remove an ammo bin in exchange for more armor.

Notable Crews

El Cid: Part of Redjack Ryan’s and Maria Morgraine’s marauders based out of the Greater Valkyrate world of Botany Bay, El Cid is a terror to Inner Sphere defenses. El Cid can be a diversion or part of an assault, keeping forces on their toes. A number of pirate-hunting warriors have come to Botany Bay to tame El Cid, but none have succeeded, with twenty-three of them losing their lives. El Cid has two crews who rotate combat time, allowing the vehicle to be far more active than it would normally be.

Johann Eggar, Stanislav Chernkov, and Joe Smith: Closing in on retirement age, these three warriors have managed to survive more vehicle destruction than any other known group. Part of an advanced striker unit for an armor regiment attached to the Third Royal Guards, they have survived the death of over thirty-five tanks, two-thirds of those Saladins. Where other crews would have been flagged for incompetence, these men have won numerous awards for their skill and willingness to accept extremely dangerous missions. Their last Saladin was destroyed after cutting down a lance of *Panthers* and dueling a *Grand Dragon* to mutual destruction.

SALADIN ASSAULT HOVER TANK

Type: **Saladin Assault Hover Tank**

Technology Base: Inner Sphere

Movement Type: Hover

Tonnage: 35

Battle Value: 596

Weapons and Ammo

AC/20

Ammo (AC) 15

Location

Front

Front

Tonnage

14

3

Equipment

Internal Structure:

Engine:

Type:

Cruising MP:

Flank MP:

Heat Sinks:

Control Equipment:

Lift Equipment:

Power Amplifier:

Turret:

Armor Factor:

Mass

3.5

7

105

ICE

8

12

0

0

2

3.5

0

0

2

Armor Value

Front

R/L Side

Rear

17

5/5

5

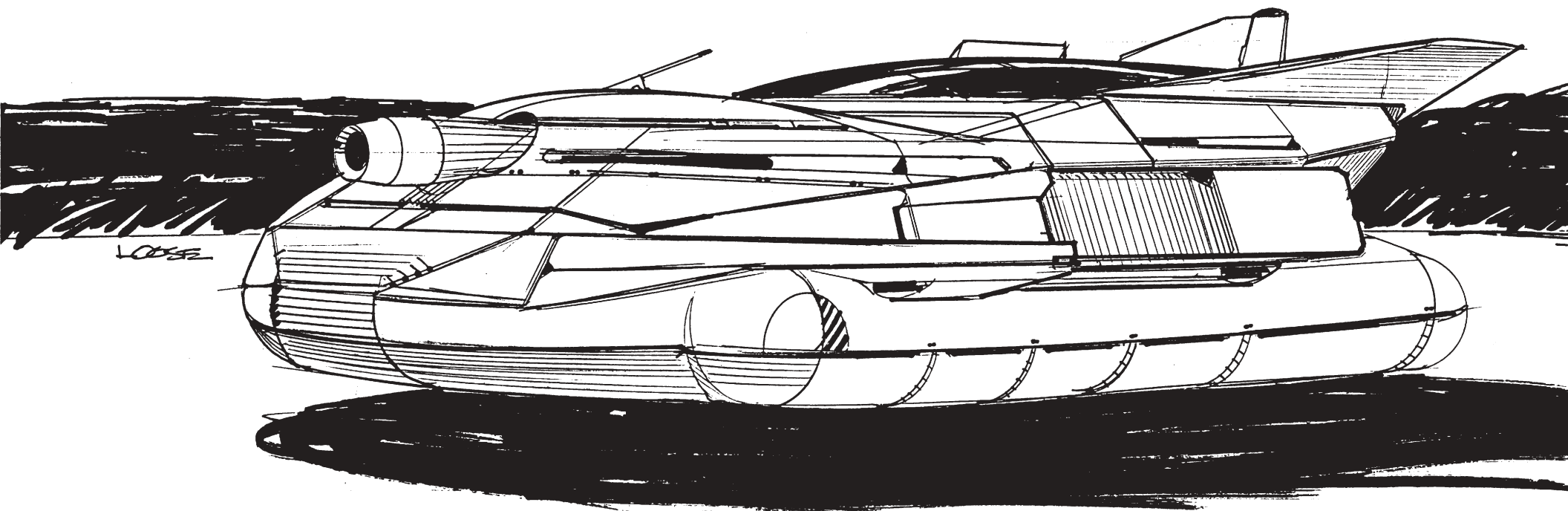

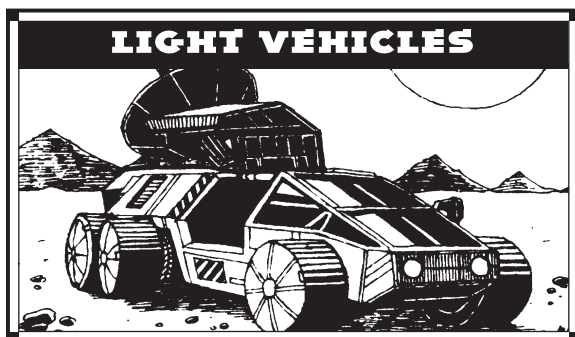

Mass: 35 tons

Movement Type: Hover

Power Plant: ConLee 105 ICE

Cruising Speed: 86 kph

Flank Speed: 129 kph

Armor: ProtecTech 7

Armament:

1 Coventry StarLight LRM 10

3 Guided Technologies SRM 2 Packs

Manufacturer: Scarborough, Ltd.

Primary Factory: Al Na'ir

Communications System: Scarborough Talky-1

Targeting and Tracking System: Scarborough
Track-1-1

Overview

The first of a line of medium hover tanks produced by Scarborough, Ltd, the Saracen was built in the latter part of the Third Succession War. Hoping that the simplicity of an internal combustion engine and the availability of parts and supplies would interest prospective buyers, Scarborough executives hit the marketing jackpot with the simple design. Within a decade, the company released two other hover tank designs, the Scimitar and the Saladin.

The Saracen is found throughout the Inner Sphere, though the Free Worlds League uses the majority. Marik issues the Saracen to units that have support or screening missions, such as cavalry and recon lances. Its mix of speed, armor, and armament allow it to perform well in both functions.

Capabilities

The Saracen mounts a variety of missile weapon systems. The Coventry StarLight LRM 10 is one of the most effective long-range combat systems available, and Guided Technologies' SRM 2 packs have a reliable battlefield record. Although an autocannon was originally intended for the Saracen (later mated to the Saladin), the designers decided that the Coventry missile systems would make the tank more versatile. With the StarLight system, the Saracen has the ability to indirectly engage targets without exposing itself to return fire.

Aside from the GT system's track record, the SRM 2 racks were also chosen for cost and survivability. At the time, GT's missile systems were among the cheapest on the market. Adding three systems allowed a Saracen to operate with a much higher degree of survivability if a system malfunctioned or was damaged; if the SRM 6 had been installed, one hit would've effectively decreased the Saracen's firepower by half.

The Saracen's speed allows it to move quickly from one firing position to another. In a delaying action, this ability allows the tank to easily break off an engagement, fall back to a new position, then engage the advancing enemy afresh with both direct and indirect fire.

Deployment

The Saracen was an immediate hit with many militia and garrison troops, especially within the Free Worlds League. The Marik Militia accounts for nearly forty percent of the yearly production of Scarborough's three tank lines.

Because of its affordability and wide assortment of spare parts available, the Saracen can also be found as a staple of many combined-arms mercenary units. It is not uncommon to find at least one lance of Saracens used as a recon lance or flanker force.

Variants

There are no registered variants of the Saracen; instead, Scarborough went a few steps further and developed two other hover tank platforms off the same chassis. Despite its usefulness on the battlefield to strategic commanders, many crews dislike Saracen duty, believing the tank to be too light a platform for such a tactical role.

Any variants that exist mainly are swap-outs of weapon components. The turret mounts are extremely versatile, allowing other manufacturer's parts to be installed in a pinch. The exceptions are the Holly brand of missile launchers. With the wiring and cyclic arming switches mounted to the side (as opposed to the rear), Holly missile launchers can't fit in the designated slots as the wires get pinched on weapon clamps. Experienced salvage crews can jury-rig such fixes, but with only a 50/50 chance of success. Failure usually results in the launcher firing when the turret is jarred.

Notable Crews

Boris Marius, Anton Grant, Marta VanLeuven: Members of the now-destroyed Insect Brigade mercenary command, these three piloted the Cockroach, the lead Saracen in the Brigade's recon lance. Distinctive due to its lengthy dual whip antenna, the Cockroach and its crew were known for using ground cover to lob several salvos of LRMs on distant targets, then speeding to cover and unloading all of its SRMs when the target reached close range. Though not a very novel tactic, the Cockroach's twist was that its SRM bin rarely went without a full load of inferno ammunition, which came as a shock and surprise to their target. The crew died during the Ronin War on Kandis, when a machine gun fusillade from a Dragonslayers *Locust* penetrated the SRM ammo bin, and shrapnel ignited the infernos.

Loch Ness Monster: Crewed by members of the Marik Militia during a raid on Pella II, the Monster was part of the delaying force and is credited with killing a *Stinger* that was threatening to turn the flank. The Monster was engaged in combat for so long that only two missiles remained when the Monster returned to the DropShip.

SARACEN MEDIUM HOVER TANK

Type: **Saracen Medium Hover Tank**

Technology Base: Inner Sphere

Movement Type: Hover

Tonnage: 35

Battle Value: 673

Weapons and Ammo

LRM 10

Ammo (LRM) 24

3 SRM 2

Ammo (SRM) 50

Location

Turret

Body

Turret

Body

Tonnage

5

2

3

1

Equipment

Internal Structure:

Engine:

Type:

Cruising MP:

Flank MP:

Heat Sinks:

Control Equipment:

Lift Equipment:

Power Amplifier:

Turret:

Armor Factor:

Mass

3.5

7

ICE

8

12

0

0

2

3.5

0

1

7

Armor Value

Front

R/L Side

Rear

Turret

24

20/20

24

24

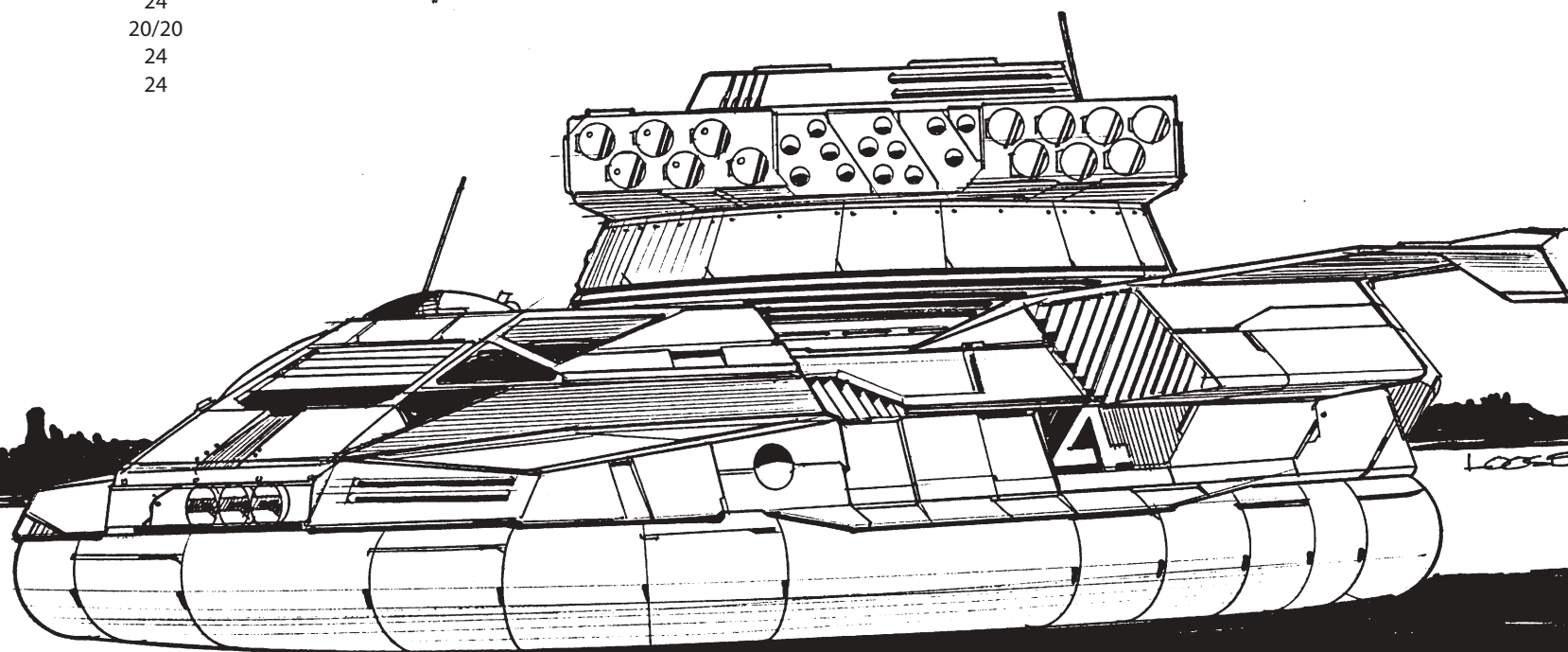

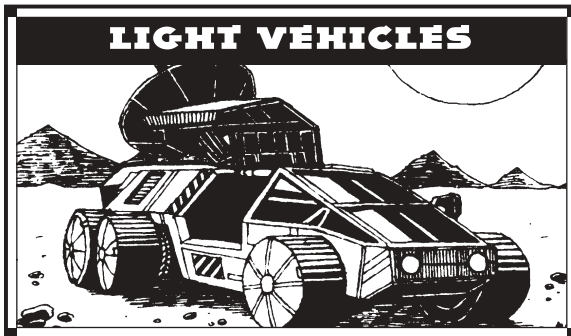

Mass: 35 tons

Movement Type: Hover

Power Plant: ConLee 105 ICE

Cruising Speed: 86 kph

Flank Speed: 129 kph

Armor: ProtecTech 7

Armament:

1 Armstrong J11 Autocannon/5

2 Guided Technologies SRM 2

Manufacturer: Scarborough, Ltd.

Primary Factory: Al Na'ir

Communications System: Scarborough Talky-2

Targeting and Tracking System: Scarborough
Tracky-2

Overview

Scarborough released the Scimitar Medium Hover Tank five years after the successful deployment of the Saracen. While the Saracen mounts missile weapons and functions primarily as a swift support vehicle, Scarborough designed the Scimitar to supplement Saracen formations with direct-fire support. The original plan called for mobile battalions comprising two companies of Saracens supported by a company of Scimitars, but practice has shown few Successor State militaries willing to place that much faith in light tanks.

Capabilities

The Scimitar is a simple tank designed for one purpose: success in battle. It avoids advanced systems, like a fusion power plant, in favor of economy of design and robust manufacture. Instead of racks of missile batteries and machine guns, the Scimitar mounts a tried-and-true Armstrong autocannon as its main gun. A pair of twin-tube short-range missiles mounted on either side of the turret supplement this gun as necessary, often firing the *coup de grace* as the Scimitar closes on an enemy.

In order to make sure sales were strong, Scarborough incorporated as many of the same components as the Saracen to help make buyers' logistical needs simpler. The Scimitar uses the same armor, the same engine, and the same brand of electronics as its predecessor, and for the first several years of its deployment Scarborough was offering discounts on parts packages designed for both vehicles.

Deployment

A strong showing in the closing years of the Third Succession War ensured the Scimitar found a ready place in armored formations all across the Inner Sphere. Although their primary factory on Al Na'ir was devoted almost solely to DCMS production, supplemental runs were marketed to all interested buyers, and a number of short-term licenses were granted to allow rapid production of the Scimitar.

Scarborough marketing teams like to showcase an engagement between a Capellan Home Guard battalion and the invading Andurien regiments during the Canopian-Andurien invasion of the Confederation just after the end of the Fourth Succession War. In this battle, large numbers of the Free Worlds light vehicles attempted to overwhelm an entrenched battalion of Capellan armor. More than half the Capellan battalion was comprised of Scimitars, with several Saracens and an assault platoon of Saladins thrown into the mix. As the Andurien Harassers and Galleons raced in, the Saracens supplied supporting missile barrages while the Scimitars laid down precision bursts of cannon fire. The thin-skinned Andurien craft quickly fell prey to the superior firepower, and when they retreated the high speed of the Scimitars and their sister craft allowed them to harass the invaders all the way back to their DropShips.

Davion units have been seen exercising recently in the Draconis March with reinforced platoons of four Scimitars and two Saracens. In mock battle on Robinson they have been observed as 'Mech hunter-killer teams, pairing with reinforced platoons of six Saladin Assault Hover Tanks to isolate and attack single 'Mechs. Their opponents in these exercises have always been Kurita 'Mechs, either *Panthers* or *Dragons*.

Variants

The majority of Scimitar crews realize they've got a good thing going and don't try to modify their tanks. Battle-damaged vehicles have been jury-rigged with ad-hoc missile launchers in place of the Armstrong, but the availability of the Saracen to missile-minded commanders makes these modifications superfluous.

Notable Crews

Nicholas Barrett and Dexter Murphy: This driver and gunner team was responsible for more kills during the Andurien engagement than any other vehicle. They held the line with the rest of the battalion during the initial assault but came to prominence during the pursuit. Teaming with a pair of Saracen support tanks, Barrett and Murphy would force a trailing Andurien hover tank to slow down to deal with the missile barrage and then punch holes in its skirts with their Armstrong. Seven Harassers fell prey to these tactics before a Andurien Galleon team charged and destroyed the Saracen missile boats. Barrett and Murphy managed to disable two of the Galleons before combined laser fire froze the turret in place with armor debris, forcing them to retreat.

Corporal Victoria Marks: Corporal Marks is a Scimitar gunner in House Marik's Second Oriente Hussars. In 3038 her unit responded to a pirate raid in the Abbey District and helped run the 'Mech-equipped bandits off-world. Although they took heavy losses (including Marks' driver) her service was specifically mentioned after the battle. Her accurate gunnery hamstringing a pirate *Assassin*, allowing the slower Marik units to surround and capture the 'Mech.

SCIMITAR MEDIUM HOVER TANK

Type: **Scimitar Medium Hover Tank**

Technology Base: Inner Sphere

Movement Type: Hover

Tonnage: 35

Battle Value: 532

Equipment

Internal Structure:		3.5
Engine:	105	7
Type:	ICE	
Cruising MP:	8	
Flank MP:	12	
Heat Sinks:	0	0
Control Equipment:		2
Lift Equipment:		3.5
Power Amplifier:		0
Turret:		1

Equipment

Armor Factor:	96	Mass	6
	<i>Armor</i>		
	<i>Value</i>		
Front	21		
R/L Side	18/18		
Rear	18		
Turret	21		

Weapons and Ammo

	Location	Tonnage
AC/5	Turret	8
Ammo (AC) 20	Body	1
2 SRM 2	Turret	2
Ammo (SRM) 50	Body	1

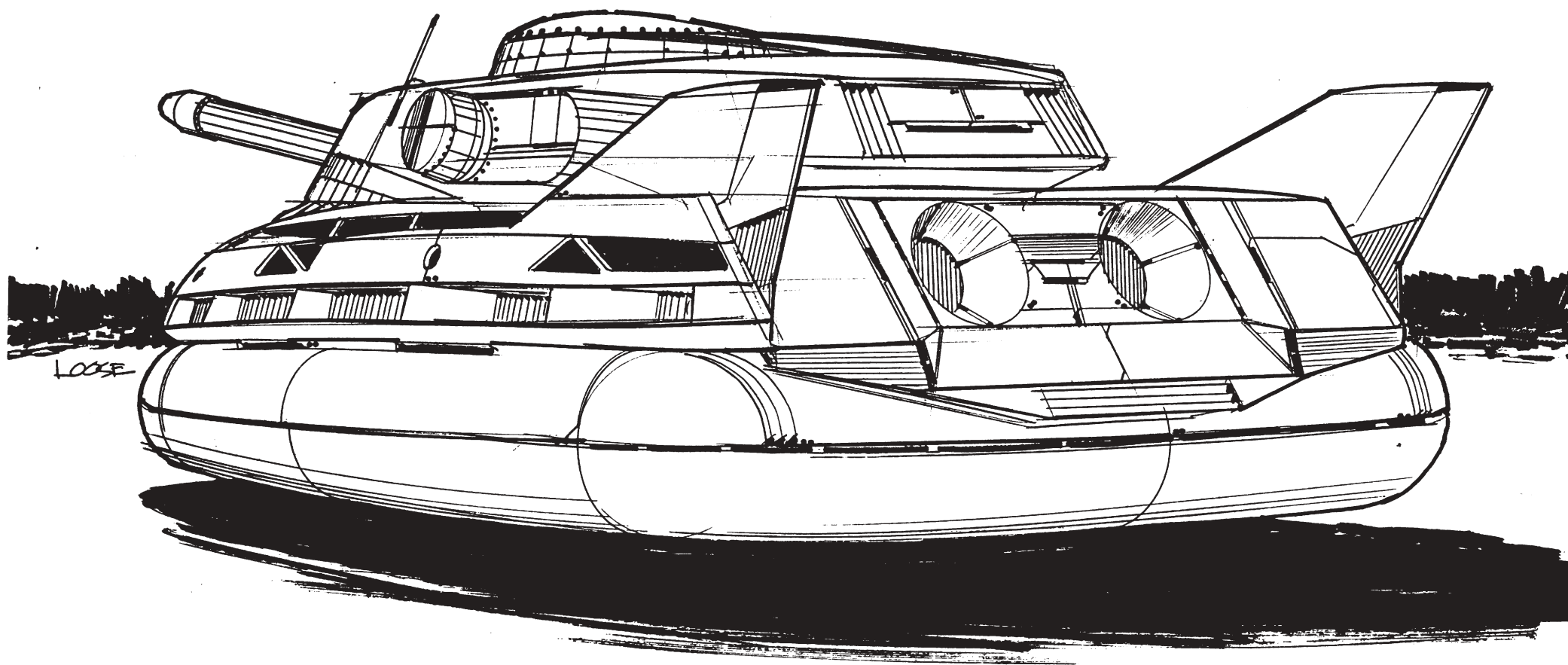

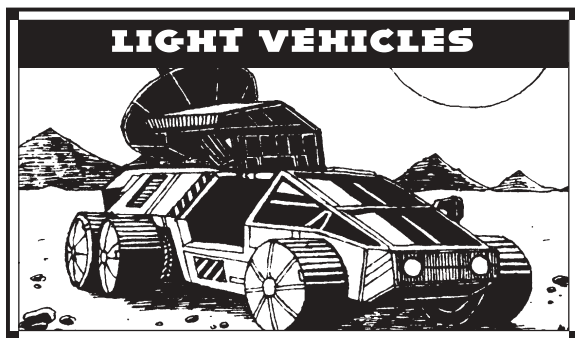

Mass: 35 tons

Movement Type: Wheeled

Power Plant: InterComBust 155 ICE

Cruising Speed: 54 kph

Flank Speed: 86 kph

Armor: Valiant Buckler

Armament:

1 Valiant Pilum SRM 6

1 Valiant Heavy Crossbow LRM 10

Manufacturer: Valiant Systems and Wunderland Enterprises

Primary Factory: Johnsondale

Communications System: Wunderland XXI-3 series

Targeting and Tracking System: Wunderland XXI-3 series

Overview

The Striker is the first product of a joint effort between two companies inexperienced in the conventional military vehicle market. The Striker light tank was doubted by its first customers, the AFFS, who viewed the wheeled vehicle as less durable than tracked vehicles and lacking the speed of hovertanks. To allay these concerns, lengthy field testing was conducted during 3006 and produced excellent results. The virtual donation of the first production run of Strikers, written off by Valiant and Wunderland as a marketing expense, helped cement AFFS interest in the tank. Subsequent AFFS success with the Striker helped the vehicle spread to other militaries.

Capabilities

Meant to be a fire-support vehicle for all ranges, the Striker performs well for its size. Two turret-mounted missile systems allow the Striker to supply both indirect firepower at long range and powerful short-range barrages at the same time. Coupled with a swift, wheeled motive system (unlike its plodding tracked counterparts), the Striker became an excellent cavalry unit, especially in urban environment.

In an effort to cut costs and address declining technology during the Succession Wars, Wunderland combined the Communication and Targeting electronics system into one suite. However, it was discovered that a lucky hit could blind and mute the tank, forcing crewmembers out of the tank to communicate using hand signs and to aim weapons manually.

Stories about the vulnerability of the Wunderland XXI-3 series came to a head after the Fourth Succession War. Worried about the impact on their sales, Wunderland executives were able to acquire information on Star League-era electronics from the Helm Memory Core via government-sponsored upgrade programs. This allowed the redesign of the electronics system that changed the Striker's internal layout to be roomier and even easier to repair and replace damaged parts, and Valiant began offering the updated Striker in 3037.

After the re-design, it was discovered the Striker electronics suite could be brought back online within minutes, even during combat with the vehicle moving at full speed evading enemy fire, by one of the crewmen replacing damaged circuit boards inside the crew compartment that were now accessible via several bulkheads. This partially defused anger against Wunderland Enterprises, and the offer of the Valiant-Wunderland joint enterprise to upgrade older Striker Light Tanks to the new version at a reduced cost secured the companies' reputation for customer service, even if it did their profit margin no good.

Deployment

The Johnsondale facility is in Federated Suns space and the AFFS remains the tank's primary customer, but exports and mercenaries have spread the design around

the Inner Sphere. Orders from the AFFS have been steady since the Striker first started production, though it was often relegated to Planetary Guards units during the first Star League.

The Federated Suns and Lyran Commonwealth Alliance opened up an entirely new market for the Valiant and Wunderland companies. Lyran commanders were impressed by the inexpensive light tanks and placed large orders. Though Valiant had increased production capacity in anticipation of future orders when the alliance was forming, the Striker's popularity outpaced even their most optimistic projections. Currently orders are on an eight month backlog, and Valiant has opened up another production line to catch up.

Variants

Predictably, a few Striker variants exist that either emphasize its long-range capabilities or its short-range firepower. Some carry bigger or more numerous long-range missile racks, or multiple SRM 2 packs in place of the SRM 6. It depends on a unit's preference and needs, but it is not uncommon for Striker companies to have half of their vehicles modified for increased ranged support, while the other vehicles are re-designed into light, short ranged brawlers.

Notable Vehicles

Young Betsey: One of the first Strikers produced using the new electronics, its first (and only) crew were veterans of Strikers, especially in maintaining and repairing the Wunderland electronics suite during their distinguished careers. They were also the first to realize and take advantage of the ability to repair the electronics suite while in combat using some extra parts they kept in the crew compartment. The commander, William Knutson, would later go on to publish a manual on maintenance and repair tricks and tips on the restructured Striker for newly assigned crews to study. Young Betsey and her crew would not survive the War of 3039 however, dying during the first wave actions on Sadalbari.

STRIKER LIGHT TANK

Type: Striker Light Tank

Technology Base: Inner Sphere

Movement Type: Wheeled

Tonnage: 35

Battle Value: 564

Weapons and Ammo

SRM 6

Ammo (SRM) 30

LRM 10

Ammo (LRM) 12

Location

Turret

Body

Turret

Body

Tonnage

3

2

5

1

Equipment

Internal Structure:

Engine:

Type:

Cruising MP:

Flank MP:

Heat Sinks:

Control Equipment:

Lift Equipment:

Power Amplifier:

Turret:

Armor Factor:

Mass

3.5

11

ICE

5

8

0

2.0

0

0

1

6.5

**Armor
Value**

Front

R/L Side

Rear

Turret

24

20/20

18

22

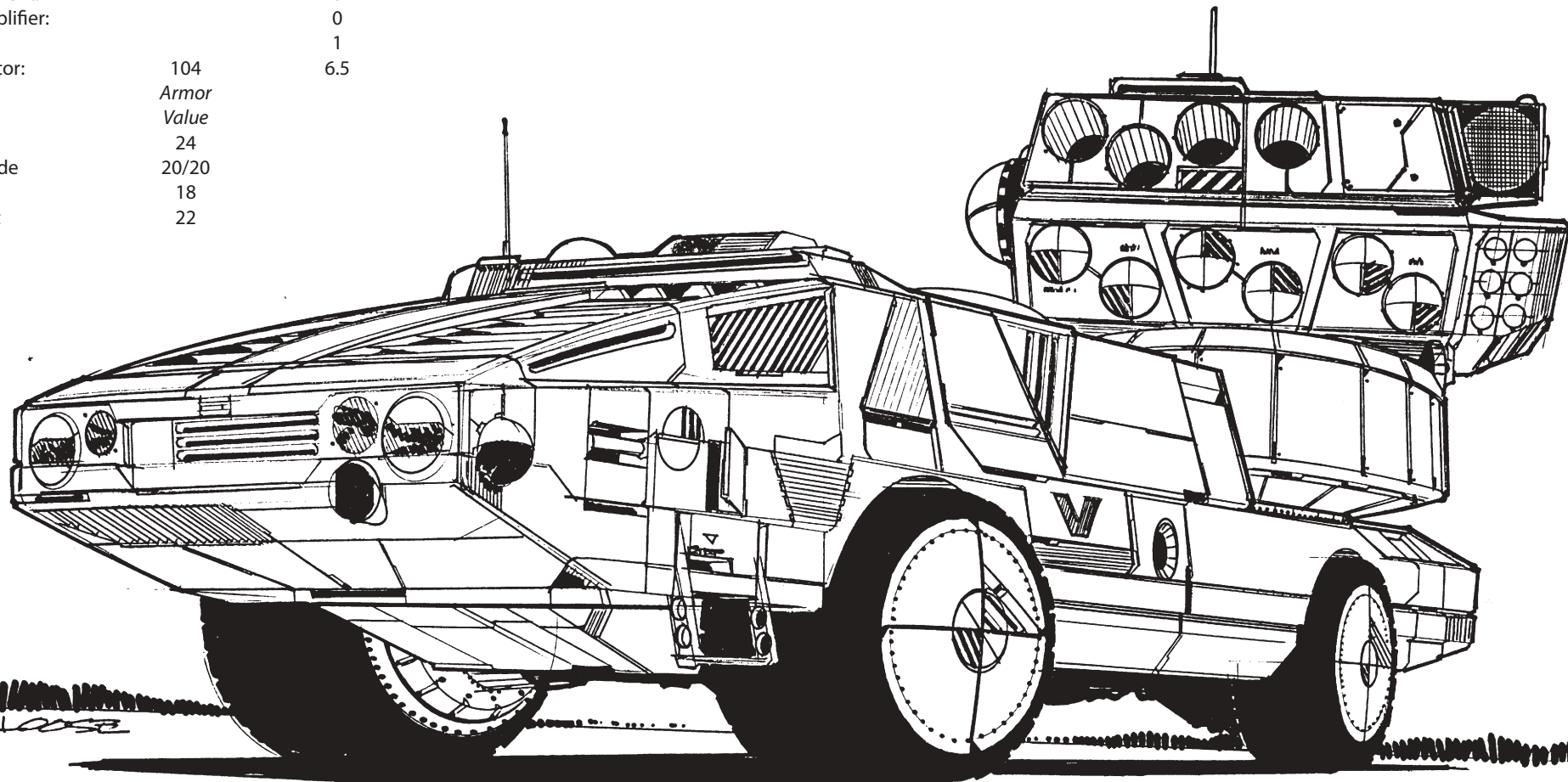

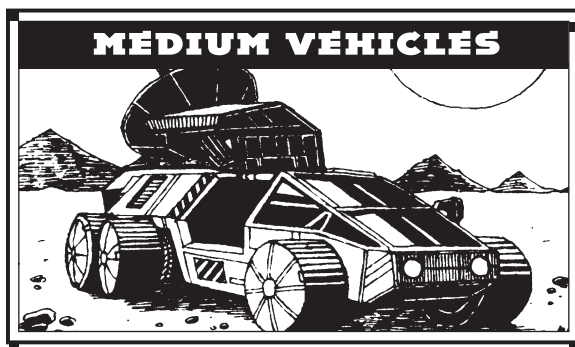

Mass: 40 tons

Movement Type: Tracked

Power Plant: WorkHorse 240 with PowerChain ICE

Cruising Speed: 64 kph

Flank Speed: 97 kph

Armor: Basic Metal Plate Standard

Armament:

None

Manufacturer: New Earth Trading Company

Primary Factory: New Earth

Communications System: TharHes Caliope HM-10

Targeting and Tracking System: None

Overview

Engineers and engineering equipment are an important part of any army. They construct the buildings, runways, and other mundane items that make up the infrastructure upon which a modern military unit depends. Engineering vehicles are also an important combat asset. They dig trenches and prepare fortifications, remove obstructions from roads, and ford rivers.

The engineering vehicles produced by the New Earth Trading Company are typical of the type of equipment employed by combat engineers across the Inner Sphere.

Capabilities

Like other engineering vehicles, the NETC version possess an oversized engine to provide the extra power needed to move heavy objects such as trees or other

vehicles. Engineering vehicles often perform the important role of removing damaged or destroyed units from the battlefield. To that end, NETC equipped their vehicle with a rear-mounted lift hoist. The sight of these workhorses hauling tanks and 'Mech limbs away to a repair facility is a common one.

NETC fitted their vehicle with a backhoe, a popular option on many engineering vehicles. Mounted on a small turret, it allows engineers to dig more efficiently without having to keep moving the vehicle.

Though never intended for heavy combat situations, engineering vehicles are lightly armored and can resist small arms fire.

Deployment

Most combat regiments can call upon a host of support units, including engineering vehicles. These are assigned to the regimental command—the administrative organization for support and technical assets—and are parcelled out for duty as the situation requires.

Engineering vehicles are also found in special combat engineer companies. These teams are often called to work while under fire, and they have a tradition of courage and skill dating back to the twentieth century. Their official motto is "Can do!"; but their unofficial one is; "First we dig them, then we die in them." Both are true.

One of the most notable uses of engineering vehicles occurred during the battle of Loric in 2978. While attempting to relieve elements of the Eridani Light Horse, the Twelfth Star Guards had broken through the main lines but were halted by some ad hoc Marik forces defending a river line. The Twelfth Star Guards sent a force of Condors to secure the other side, but the river was too swift and its banks too steep to allow 'Mechs or more conventional vehicles to cross. The Star Guards possessed four engineering vehicles and a company of engineers. The engineers immediately went to work throwing up a pontoon bridge, while the vehicles began to prepare a fording point. Marik aerospace fighters and long-range artillery kept the engineers under constant fire, destroying three pontoon bridges before they could be completed.

The engineer company was decimated, but the engineering vehicles cut down the banks to the river and prepared the river bottom for a 'Mech crossing. Though three of the vehicles were destroyed in the process, the final vehicle was able to complete the crossing point, which allowed the Star Guards to cross to relieve the beleaguered Eridani Light Horse.

Variants

There exists a plethora of different engineering vehicles. Most employ tracks, though a number of specialized hover versions can be found. In addition to the backhoe and lift hoist, common items of equipment include cutters for clearing trees, front-mounted shovels or dozer blades, drills, mine-clearing equipment, and even bridge-laying equipment. Some vehicles mount weapons such as flamers to burn away dense undergrowth or an AC/20 for destroying obstacles.

Notable Crews

El Magnifico's Engineering Company: "El Magnifico" is the codename for the Twelfth Star Guards' engineering unit, which employs some of the best engineers in the Inner Sphere. The story goes that they actually did build New Rome in a day, but didn't want to show off, so they tore part of it down and rebuilt it again.

Though the unit was decimated during the battle of Loric, the grateful Steiner government replaced all of the unit's equipment in addition to paying the normal bonus.

Eighty-first Combat Engineers Company: A crack team of Federated Suns combat engineers, the Eighty-first has served on both the Capellan and Combine fronts during the course of the Succession Wars. The unit is best known for their commander's heroic stand during the Second Succession War. Using explosives and construction equipment, Captain Wedge Donovan single-handedly halted a Capellan column in the mountains on Atlas, annihilating a company of 'Mechs before he was killed when his engineering vehicle was destroyed.

Type: Engineering Vehicle

Technology Base: Inner Sphere

Movement Type: Tracked

Tonnage: 40

Battle Value: 194

Equipment

Internal Structure:

Engine: 240

Type: ICE

Cruising MP: 6

Flank MP: 9

Heat Sinks: 0

Control Equipment: 2

Lift Equipment: 0

Power Amplifier: 0

Turret: .5

Mass

4

23

0

2

0

0

.5

Equipment

Armor Factor:

40

Armor

Value

Front 8

R/L Side 8/8

Rear 8

Turret 8

Weapons and Ammo

Backhoe

Lift Hoist

Location

Turret

Rear

Tonnage

5

3

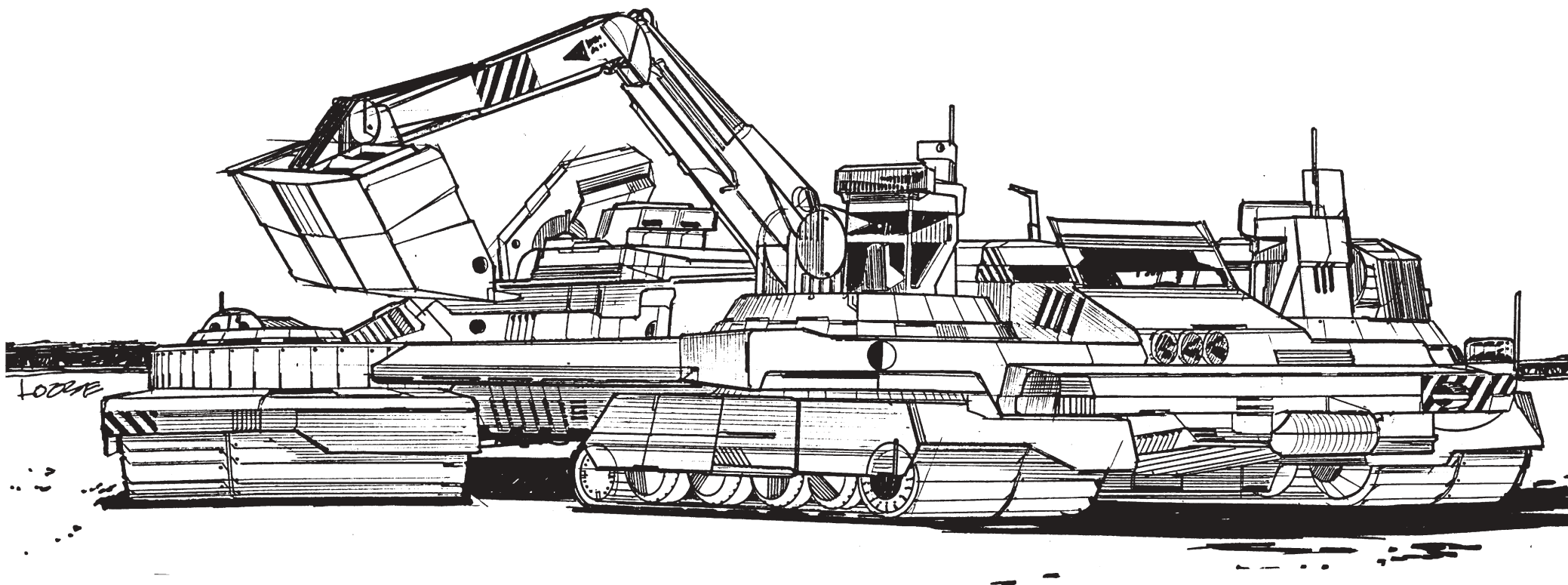

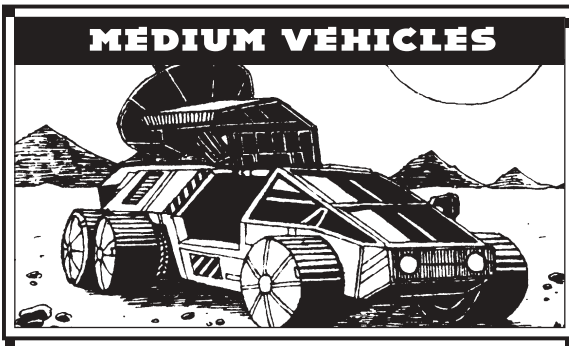

Mass: 40 tons

Movement Type: Wheeled

Power Plant: SitiCide 140 ICE

Cruising Speed: 43 kph

Flank Speed: 64 kph

Armor: StarSlab/6

Armament:

1 Crusher SH Cannon Autocannon/20

Manufacturer: Quikscell Company

Primary Factory: Indicass, Kalidasa, Alshain

Communications System: Johnston Q-Band

Targeting and Tracking System: Scantrex Dual Tac

Overview

Quikscell Corp. developed the Hetzer Wheeled Assault Gun, called the "H-WAG" by English-speaking crews, to meet the needs of poorer worlds and Periphery realms that could not afford the expense of first-tier armor assets. Quikscell mounted the powerful and reliable Crusher 20 autocannon on a frame sturdy enough to transport it, with a low cost but reliable ICE, and then they threw in a targeting system adequate to locate other vehicles and topped it off with the barest minimum of armor. To cut down on production expenses, the Hetzer was designed without a turret.

Capabilities

"Wheeled assault gun" sums up the Hetzer perfectly. It is a single gun, powerful enough pose a threat to anything on the battlefield, with wheels and little else. Maneuverable but not particularly fast and woefully under-armored, every aspect of the Hetzer causes designers and engineers to question the morality of the Quikscell accountants who are suspected of designing the Hetzer.

But tacticians, particularly those strapped for cash, understand the vehicle perfectly: it's the cheapest way to get a big gun where it needs to be. The implication that the lives of the crew are equally cheap is never lost on those assigned to the wheeled assault gun. Those manning a Hetzer usually fall into one of three groups: those being disciplined, those who lack the talent or initiative to get out, and those who take a perverse pride in going to battle with the little chance of survival.

Well aware of the lack of armor, Quikscell designed the Hetzer to dig in during battle. Entrenched Hetzers, presenting only their marginally adequate front armor and massive cannon to the enemy can be hard to hit, and they deliver enough firepower to blunt all but the most determined assault.

Deployment

True to Quikscell's marketing strategy, H-WAGs are usually found in backwater planetary militias and the Periphery. The only major House to purchase Hetzers in any quantity is Liao, where Hetzers can be found in garrison units throughout the Capellan Confederation. [EDITOR'S NOTE: This has proven to be a boon to less prestigious buyers. Hetzers were often delivered with some auxiliary systems absent or casually dropped in the tank's crew compartment. A condition of the Capellan contract is that Hetzers ship with all wiring and secondary systems installed. Quikscell determined it was more cost-effective to complete assembly on all Hetzers, not just the Capellans', than to continue paying out on warranties for minor customers.] While it is likely that every House has a few Hetzers, it is common for major military units to either strip captured Hetzers of useful equipment or simply bequeath them to the local militia.

Variants

Quikscell has invested no R&D funds in developing variants of the Hetzer, but the ubiquitous vehicle is frequently modified by local commands. Most common is the replacement of the Crusher with a smaller gun, followed by adding armor and ammo. However, this eliminates the assault gun's only advantage on the battlefield, the one-hit kill. The advantages of more, but less potent, shots and the slight upgrade in armor protection may not be worth the trade. Short- or long-range missile racks are also popular choices, but the lack of a turret limits their usefulness, and the questions of firepower reduction remain. Lasers are an option for those wishing to avoid the cost and limitations of munitions weapons, but few Hetzer users have techs trained to maintain technology as advanced as lasers.

Notable Crews

Leftenant Jean Gieschen: In 3021, the planetary militia of Inner End purchased six Hetzer Wheeled Assault Guns to augment their all-infantry militia and turned to the Kilbourne Draconis March Militia for guidance on how to best use them. Leftenant Jean Gieschen was assigned cadre duty, charged with training the militia on the fundamentals of armor tactics, when a pirate band attacked. Holding's Horrors fielded a single lance of older light and medium BattleMechs, the largest being Holding's VL-2T *Vulcan*. The Horrors simply strode through the militia infantry toward DropPort warehouses seeking plunder. With no communication from IEPM command (the Hetzers still lacked radios), Gieschen chose to attack. She ordered a broken-pattern advance covered by port buildings. Commanding a force without active targeting or communication systems, Gieschen rode "unbuttoned" to direct her force by handheld radio. Unaware of the Hetzers, Holding's lance did not realize their danger until the massed fire of six Crusher autocannons caught their leader in a withering crossfire. The *Vulcan* collapsed in fragments without firing a shot. The light 'Mechs used their speed and jump capabilities to flee the unseen enemy.

HETZER WHEELED ASSAULT GUN

Type: **Hetzer Wheeled Assault Gun**

Technology Base: Inner Sphere

Movement Type: Wheeled

Tonnage: 40

Battle Value: 574

Weapons and Ammo

AC/20

Ammo (AC) 20

Location

Front

Body

Tonnage

14

4

Equipment

Internal Structure:

Engine:

Type:

Cruising MP:

Flank MP:

Heat Sinks:

Control Equipment:

Lift Equipment:

Power Amplifier:

Turret:

Armor Factor:

Mass

4

10

ICE

4

6

0

0

2

0

0

0

6

*Armor
Value*

Front

R/L Side

Rear

30

22/22

22

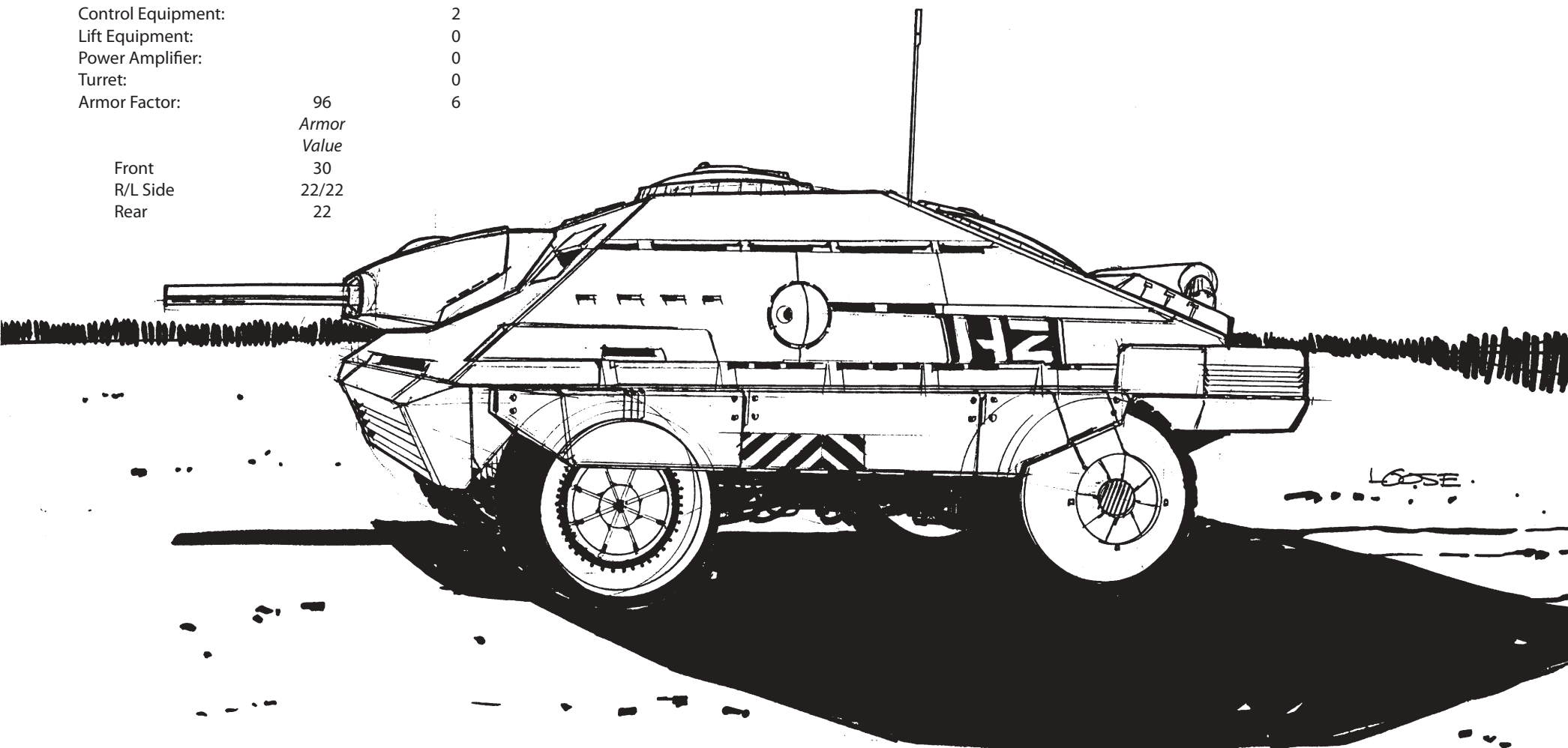

LOOSE

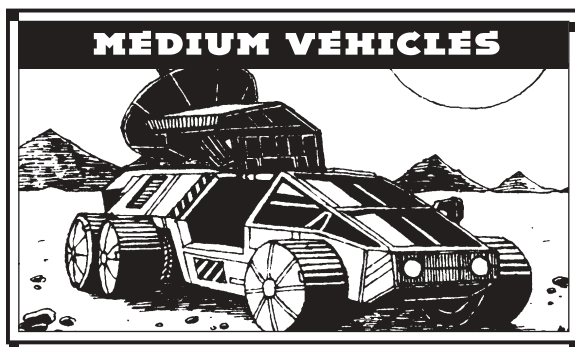

Mass: 45 tons

Movement Type: Tracked

Power Plant: LongWay 180 ICE

Cruising Speed: 43 kph

Flank Speed: 64 kph

Armor: ProtecTech 9

Armament:

1 BlazeFire Systems Large Laser

1 Johnston Minigun Machine Gun

Manufacturer: Johnston Industries

Primary Factory: New Syrtis

Communications System: CommuTech XL

Targeting and Tracking System: BlazeFire tracker with RangeCheck

Overview

No one knows where the design concept for the Goblin originated, but it appeared either during the final years of the so-called Age of War or the early first Star League. The Goblin's production was taken over by Johnston Industries towards the end of the First Succession War.

Capabilities

Instead of mounting a bulky autocannon or cumbersome missile units, the Goblin's main weapon is a large laser. The energy weapon possesses both good range and firepower without the need to carry ammunition. The BlazeFire Systems Large Laser lacks the long barrel of an autocannon, allowing for a compact turret design that is

not hindered by tight quarters. The BlazeFire targeting and tracking system has optional link-ups for the rest of the tank's three-man crew so that one of them can fire if the gunner becomes disabled, but the MiniGun can only be fired by the driver.

The Goblin's most interesting feature is the infantry compartment in the rear of the tank. Large enough to hold seven infantrymen and their equipment or one support weapons team, the compartment is surprisingly spacious and reasonably comfortable.

With organic infantry support and a turret design not hindered by a long barrel, the Goblin is an excellent urban combat vehicle.

Deployment

The Goblin is a common vehicle with Federated Suns mechanized infantry regiments and with armored battalions that can expect to work regularly with infantry. It is also very popular with the Ceti Hussar regiments. During the Second and Third Succession Wars, Kuritan and Capellan troops captured Goblins and pressed them into service.

Several Goblins were discovered amongst the cache of arms on Terra from which the Com Guards were formed. Unfortunately, detailed examination of these ancient vehicles failed to uncover the Goblin's origins.

During a raid on the Combine world of Weisau, a company of Goblins from the Third Ceti Hussars found themselves cut off from their DropShips by enemy forces. Stuck on a hostile planet with no supplies and no indications of a DropShip coming to rescue them, Captain Reginald Rosseter devised a plan to transmit their location to friendly troops still in the system, or at least to wreak havoc among the enemy.

Rosseter sent out his infantry on raiding and reconnaissance missions to locate food and equipment. The infantry's secondary mission was to raid any small towns and villages they encountered, and their tertiary objective was to hit any 'Mech- and vehicle-repair stations found.

Within a week, the infantry had discovered three small villages and a DCMS 'Mech service outpost. The outpost was the first target. Rosseter held back the infantry for a

later fight and sent the Goblins in to attack the outpost. They managed to destroy it before Kurita troops could relay a message to their commanders.

The infantry attacked the first village under cover of night. The village was only lightly defended and certainly not prepared for a sneak attack. After only a few minutes, the infantry captured a long-range communications station. Captain Rosseter decided to wait until the other villages in the area were under his control before using the transmitter.

The second and third villages fell just as quickly as the first. The last village was somewhat more prepared, however, so the fighting lasted longer. The village defenders never really had a chance against the combined forces of the infantry platoons supported by the Goblin's lasers.

After the last village fell, Rosseter used his captured comm gear and was able to contact an inbound DropShip force that had been sent to look for his command, and the Hussar detachment escaped Weisau at last.

Variants

Some Goblins have been modified by replacing the large laser with long-or short-range missile systems. [EDITOR'S NOTE: missile variant shown at right] A rare Kurita variant of the Goblins is armed with an SRM 6 rack in the turret and five extra machine guns controlled by the infantry.

Notable Crews

Nick Vigilante: Davion Goblin Commander Lieutenant Nicholas Vigilante was promoted to Captain after his daring raid against a Kuritan Long Tom howitzer train that was harassing Davion 'Mechs from its hiding place in a valley. Though the Davion defenders had sent out several search parties to locate the gun, none had been successful. It was Lieutenant Vigilante's infantry squad that finally discovered the howitzer by chance. The squad immediately called to Vigilante and his Goblin, the "Hornet's Nest", for support. As Vigilante could not move the tank into the heavily wooded area, he dismounted and personally led his infantry in destroying the howitzer and crew.

GOBLIN MEDIUM TANK

Type: **Goblin Medium Tank**
 Technology Base: Inner Sphere
 Movement Type: Tracked
 Tonnage: 45
 Battle Value: 555

Equipment		Mass
Internal Structure:		4.5
Engine:	180	14
Type:	ICE	
Cruising MP:	4	
Flank MP:	6	
Heat Sinks:	8	8
Control Equipment:		2.5
Lift Equipment:		0
Power Amplifier:		.5
Turret:		.5

Equipment		Mass
Armor Factor:	128	8
	<i>Armor</i>	
	<i>Value</i>	
Front	30	
R/L Side	24/24	
Rear	20	
Turret	30	

Weapons and Ammo	Location	Tonnage
Large Laser	Turret	5
Machine Gun	Front	.5
Ammo (MG) 100	Body	.5
Infantry Bay	Body	1

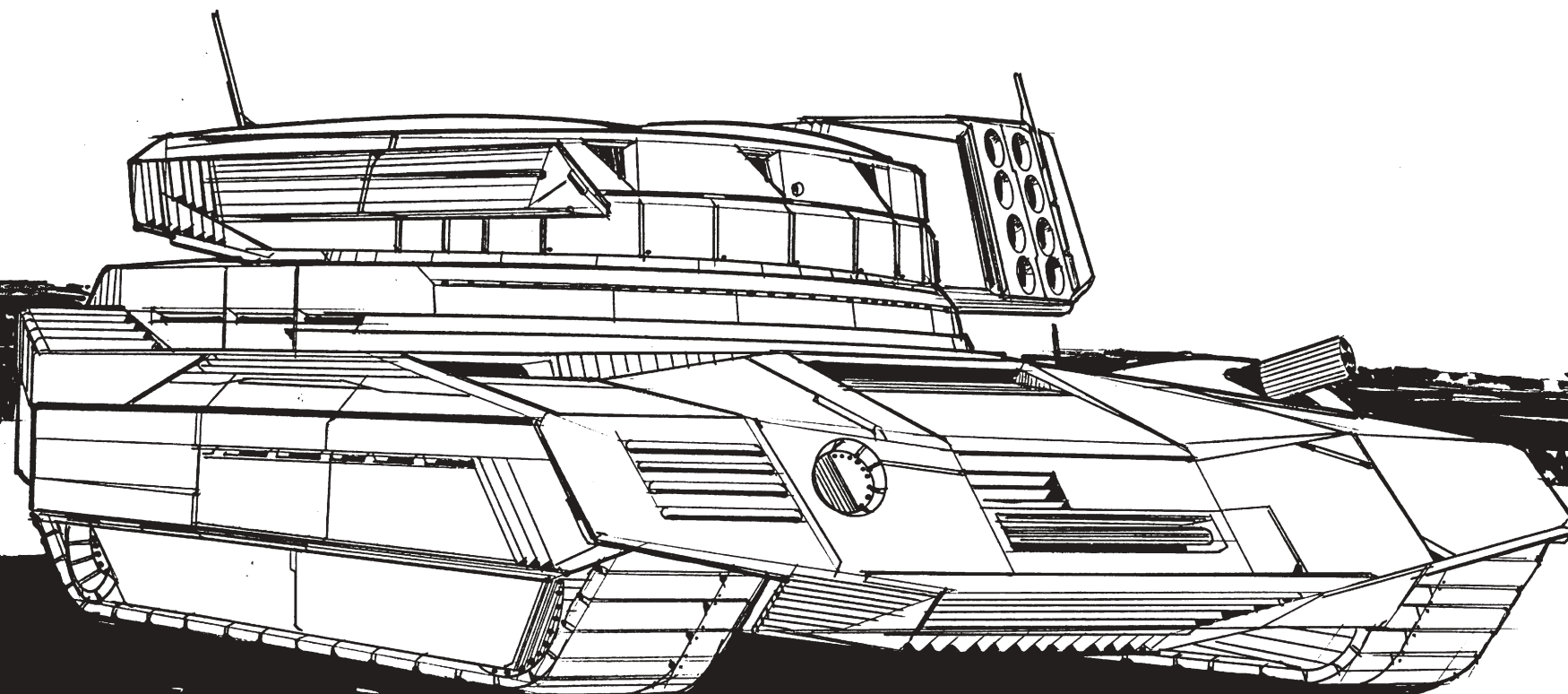

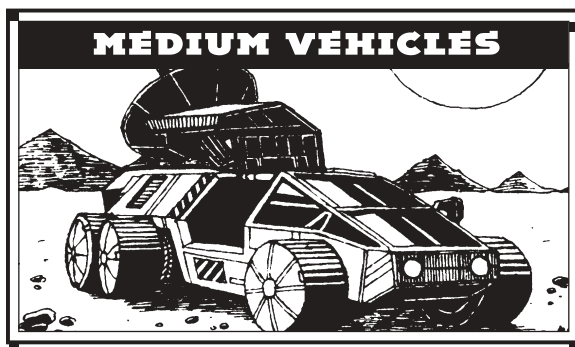

Mass: 50 tons

Movement Type: Hover

Power Plant: Jones 165 ICE

Cruising Speed: 86 kph

Flank Speed: 129 kph

Armor: StarSlab/9.5 Mk II

Armament:

1 GM Whirlwind Autocannon/5

2 Defiance B3M Medium Lasers

1 SureFire MiniGun Machine Gun

Manufacturer: Red Devil Industries

Primary Factory: Pandora

Communications System: TharHes KR-A P/Comm

Targeting and Tracking System: TharHes Mars 1

Overview

A heavy cavalry unit designed for rapid reaction to a shifting battle, the Condor was one of Red Devil's first military products, produced and sold since a few years before the formation of the Star League.

Demand for the hover tank remained steady throughout the Succession Wars due to Red Devil using their considerable influence to gain permission to sell to customers not currently hostile to the Lyran Commonwealth, namely the Capellan Confederation and the Federated Suns. Many of the Condor's critics point to the vehicle's relatively high price tag, though much of that is attributed to the heavy tariffs the mercantile Steiner Empire has levied on exports.

Capabilities

One of the fastest vehicles in its weight class, topping out at nearly 130 kph, the Condor's speed is rivaled only by much smaller vehicles and BattleMechs. Its six tons of armor are concentrated mostly on the front and turret, giving it considerable survivability on high-speed passes but leaving it critically weak on the sides and rear. Many Condors are destroyed due to this weakness, as would-be targets try to use dispersed formations to take advantage of the armor distribution.

Its weapon systems are varied but adequate. Turret-mounted medium lasers and an autocannon provide the bulk of the firepower, while a single machine gun is used to fend off infantry attacks. When Red Devil decided to mount Defiance B3M Medium lasers on the Condor, Defiance Industries refused to license the lasers, forcing Red Devil to create an odd bounty program for used or slightly damaged lasers. The program brought in lasers at the expense of Defiance-built machines like the *Zeus*, which were gaining reputations as deathtraps. Defiance moved to protect its reputation by finally licensing the laser to Red Devil (which subsequently licensed the laser to the Exeter Organization for the Pegasus).

Deployment

The formation of the Federated Commonwealth dropped the significant tariffs levied against the export to the Davion side of the alliance, allowing the former AFFS to buy in larger quantities (without an increase in price) than it would otherwise.

However, since the alliance became official, the once considerable sales to the Capellan Confederation were no longer allowed, and the overall incoming funds to Red Devil Industries have dropped sharply. With several executives already under investigation for embezzling funds and bribery, the budget for facility maintenance and upkeep has taken a huge hit, and the production infrastructure has started to show its wear and tear after the last decade of improper care.

Variants

Being such an old vehicle, the Condor saw many changes as improved internal combustion engines and better weapons and armor became available. After the proliferation of the BattleMech, however, updates stopped due to Red Devil's belief that the popularity and overall superiority of BattleMechs would make conventional military vehicles extinct within a century. Only the latest update of the Condor remains in use today.

While the Steiners traditionally use the stock model, AFFS and CCAF units often modify their Condors to suit their tastes. While the Davions utilize more autocannons on their vehicles, typically twin class-2 autocannons installed at the expense of the lasers and GM Whirlwind, the Capellans instead remove the Whirlwind for more lasers.

Notable Crews

Major Craig Stewart: During the initial battles of the Fourth Succession War on the Southern continent of Aldebaran, House Liao intercepted orders sending the Redfield's Renegades off the planet. Sensing an opportunity, Warrior House Ijori's second battalion set a trap in the Ducoal Swamp and inflicted heavy casualties on the unit. While ignoring the supporting infantry of the Fourth Deneb Light Calvary, the Ijori fighters chased the BattleMech unit to its landing zone, where a pitched battle to save the transports ensued.

While the infantry was classified as mechanized, many of its transports were tracked vehicles that got caught in the muck of the swamp. With their landing zone and DropShips a mere one hundred meters away from the enemy BattleMechs, and the defending Renegades desperate for reinforcements, Major Craig Stewart, also of the Fourth Deneb, ordered his battalion of Condor Heavy Hover tanks to allow the infantry to climb out of the mud and onto the hulls with many of their man-portable support weapons. Though the hover vehicles lost some speed due to the extra weight, the units were able to meet up with the other conventional units in time to reinforce the Renegades and destroy House Ijori.

CONDOR HEAVY HOVER TANK

Type: **Condor Heavy Hover Tank**

Technology Base: Inner Sphere

Movement Type: Hover

Tonnage: 50

Battle Value: 653

Equipment

Internal Structure:

Engine: 165

Type: ICE

Cruising MP: 8

Flank MP: 12

Heat Sinks: 6

Control Equipment: 2.5

Lift Equipment: 5

Power Amplifier: .2

Turret: 1

Mass

5

12

6

2.5

5

.2

1

Equipment

Armor Factor:

96

Armor

Value

Front

30

R/L Side

15/15

Rear

14

Turret

33

Weapons and Ammo

AC/5

Location

Turret

Ammo (AC) 20

Body

2 Medium Lasers

Turret

Machine Gun

Front

Ammo (MG) 100

Body

Cargo

Body

Mass

6

Tonnage

8

1

2

.5

.5

.3

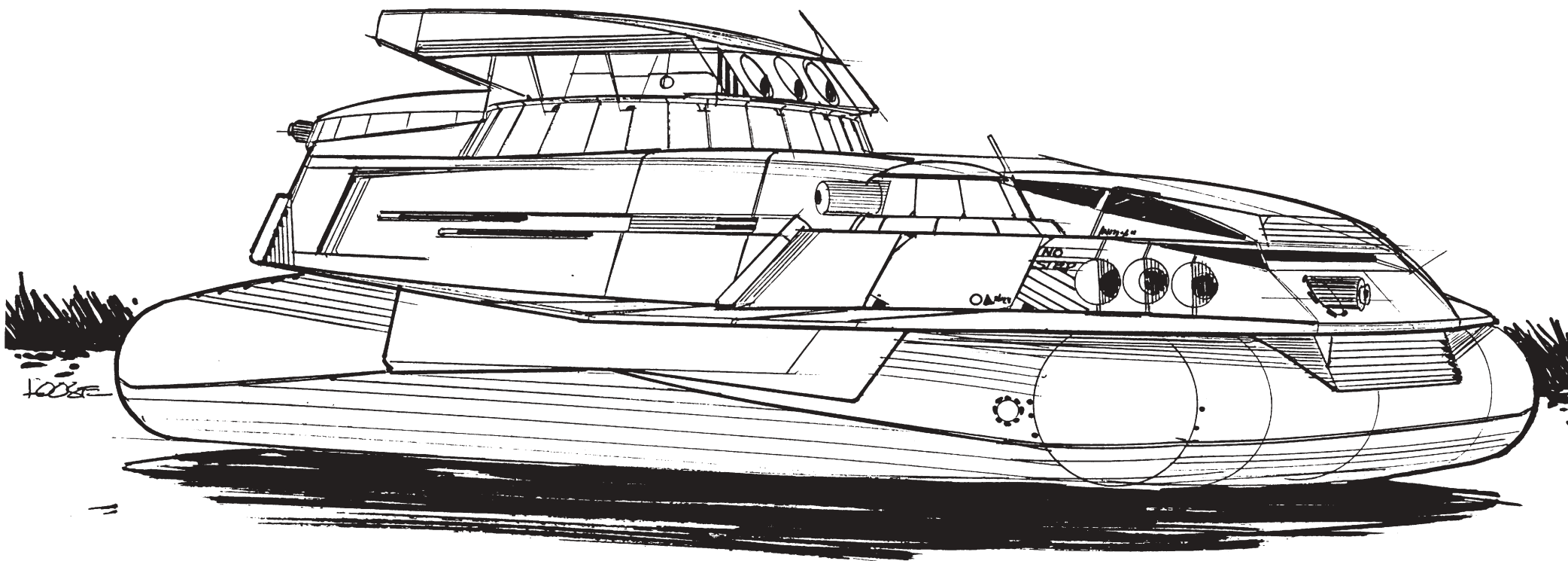

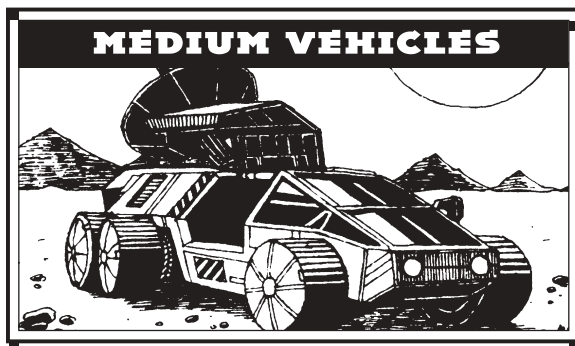

Mass: 50 tons

Movement Type: Hover

Power Plant: MaxLift 215 Fusion

Cruising Speed: 97 kph

Flank Speed: 151 kph

Armor: ArcShield Heavy

Armament:

1 Cyclops Eye Large Laser

2 Hovertec SRM 2 Packs

1 Light Crossbow LRM 10

2 Kicker Machine Guns

Manufacturer: Cyclops Incorporated

Primary Factory: New Earth

Communications System: Cyclops 1

Targeting and Tracking System: Evil Eye

Overview

In 3025 Cyclops Incorporated on New Earth released the Drillson Heavy Hover Tank to the Lyran military. Its combination of heavy armor, speed, and hitting power made it an instant favorite of even the hidebound Lyran generals, and Cyclops soon had its job cut out for it meeting the deluge of orders from across the Inner Sphere. This was especially true in the wake of the Fourth Succession War.

The slaughter of that war meant that the LCAF had many holes in its ranks to fill with new vehicles, and the new alliance with the Federated Suns opened that realm's military to Lyran markets as well. Davion officers,

impressed with the Drillson's showing during the Fourth War, convinced the AFFS Department of the Quartermaster to procure as many Drillsons as possible. To meet demand, Cyclops opened six new lines on New Earth by 3035.

Capabilities

The centerpiece of the Drillson is its electronics. The Evil Eye targeting and tracking system, a revolutionary 360-degree vision system similar to the heads-up display in BattleMech targeting systems, proved itself during the Fourth Succession War as one of the finest conventional electronics systems in use.

The Drillson's main gun is the Cyclops Eye large laser system. The Cyclops Eye is unique among large lasers in that it doesn't use the long and vulnerable focusing "barrel" common to other lasers. Instead, the weapon fires from a slit on the turret, giving the Drillson a more sleek and aerodynamic aesthetic. While the engineering is dissimilar from standard laser weaponry, the performance of the Cyclops Eye is indistinguishable from comparable laser models from manufacturers like Diverse Optics or Martell.

A bow-mounted Crossbow LRM system gives the Drillson sting at range, while a pair of Hovertec SRM 2 systems and twin Kicker machine guns provide the Drillson's close-in firepower. A top speed of over 150 kilometers per hour is, however, the Drillson's best defense.

What truly endears the Drillson to Lyran commanders is its impressive armor. With almost seven tons of ArcShield armor on the chassis, the Drillson can take more punishment than most suspect a hovercraft can absorb.

Deployment

The rapid expansion of production in the early 3030s allowed the Drillson to spread across the Inner Sphere, although the lion's share remains in the allied nations of the Lyran Commonwealth and the Federated Suns. The Capellans have lumped most of theirs into the battalions of the Home Guard and several prominent Liao-sponsored mercenary units such as McCarron's Armored Cavalry.

There were persistent rumors that Cyclops had been approached by ComStar about purchasing the Drillson for

their (then) newly-revealed Com Guards. [EDITOR'S NOTE: Though Drillsons certainly entered Com Guard ranks after the loss of Terra's manufacturing centers to the Word of Blake, it remains doubtful that the Com Guards of the 3030s, equipped with Star League-vintage units, would purchase a vehicle as primitive as the Drillson.]

Variants

The only factory-authorized variant of the standard Drillson is a model that removes the long-range missiles for more Hovertec launchers. This model is most often used in urban garrisons, where the long-range LRM rack is almost never used. The majority of the Capellan Drillsons are this model, but examples of it appear anywhere Drillsons are found. [EDITOR'S NOTE: In 3039, the hot rumors were of a Drillson mounting a longer-ranged version of the Cyclops Eye large laser, technology now known to be an extended-range large laser. However, as the Inner Sphere also now knows, Cyclops' primary updated production model of the Drillson incorporated Streak missile packs and a large pulse laser when it was introduced in the 3050s.]

Notable Crews

Force Commander Henry Cannon: Force Commander Cannon is the commander of two companies of Free Worlds League Military armor that routinely practice as the opposing force (OpFor) in training exercises all across the League. As of 3039 he is stationed on Tamarind, operating against elements of the Marik Militia from nearby worlds. His unit is currently configured as a Lyran raiding party, which means a lot of Drillsons. After having spent more than fifteen years in near-constant mock combat, Major Cannon is considered one of the few true experts in armored warfare in the FWLM. His specialty is a tactic he calls the hide-and-seek. He uses small units of swift vehicles like the Drillson or Saracen to draw the enemy into terrain of his choosing, where he's hidden his heavier elements. Many armor crews have chased a lone Drillson around a copse of trees and met the pair of waiting Ontos tanks.

DRILLSON HEAVY HOVER TANK

Type: **Drillson Heavy Hover Tank**

Technology Base: Inner Sphere

Movement Type: Hover

Tonnage: 50

Battle Value: 950

Equipment

Internal Structure:

Engine: 215 Mass 14.5

Type: Fusion

Cruising MP: 9

Flank MP: 14

Heat Sinks: 10

Control Equipment: 2.5

Lift Equipment: 5

Power Amplifier: 0

Turret: 1

Equipment

Armor Factor: 104 Mass 6.5

Armor

Value

Front 24

R/L Side 19/19

Rear 18

Turret 24

Weapons and Ammo

Large Laser Turret 5

2 SRM 2 Turret 2

Ammo (SRM) 50 Body 1

LRM 10 Front 5

Ammo (LRM) 12 Body 1

2 Machine Guns Front 1

Ammo (MG) 100 Body .5

Location

Tonnage

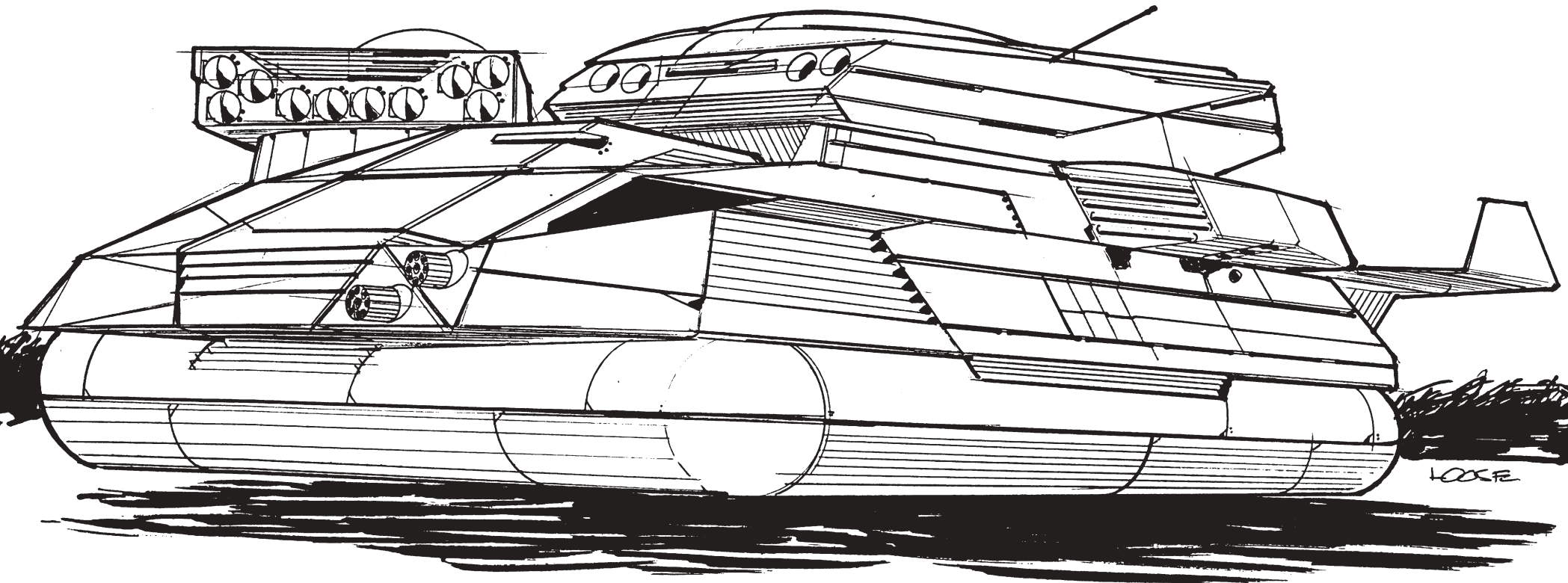

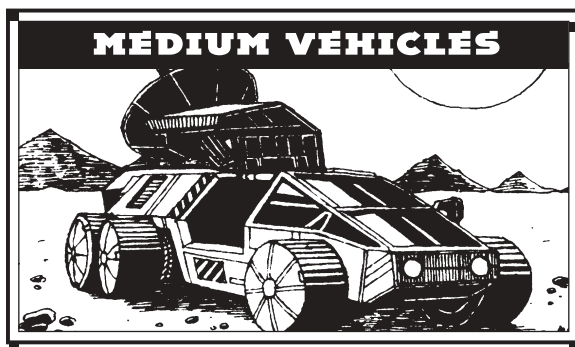

Mass: 50 tons

Movement Type: Hover

Power Plant: PowerTech 165 Highlift ICE

Cruising Speed: 86 kph

Flank Speed: 129 kph

Armor: ArcShield V

Armament:

1 SureShot VI SRM 6

3 Heavy Machine Guns

3 LongFire V LRM 5

2 SureShot II SRM 2

Manufacturer: Scarborough Manufacturers,
Cyclops Incorporated, Hellespont Industrials

Primary Factory: Al Na'ir (Scarborough),
Skye (Cyclops), Sian (Hellespont)

Communications System: Maxim New Standard I/O

Targeting and Tracking System: Maxim New
Standard TargetTrack

Overview

While many infantry transports have been popular, none have reached the iconic status of the Maxim. Designed and produced initially by Maxim Transport Industries, a start-up company on Al Na'ir led by a retired infantry general, nobody expected just how quickly the Maxim would become a success. Now considered the meterstick for troop transports, the Maxim has proliferated to every corner of

the Inner Sphere. Many units were overjoyed at being able to transport their infantry platoons with a single vehicle, as opposed to three or four separate vehicles. The company flourished and subsequently opened plants on Skye, Sian and along with plans to open plants on Atreus and Kathil once several more vehicles could be produced.

However, while the Maxim was a huge success, many of MTI's other forays into the military market proved to be dismal failures, and the company barely scraped by in its existence. A huge scandal erupted throughout the company during the start of 3037, sealing its demise. Accusations of inappropriate activity between coworkers, embezzlement, and rumors of bizarre hazing rituals led to the downfall and dissolution of the company. Prominent corporations, sensing an opportunity, procured nearby Maxim facilities at low rates, and in the case of the facility on Sian, with armed force.

Capabilities

The Maxim transport proved to be an infantryman's dream come true. Its single infantry bay is configured so an entire foot platoon can be carried with enough space to check their weapons and move around comfortably. The seats are all padded and face toward the center of the vehicle, enabling infantry to talk to each other and boost morale. When debarking or mounting up, the Maxim's crew can deflate the rear portion of the hover skirt, unlike other craft that need to shut down the engine.

When inside a combat situation, the Maxim receives high marks as well. The vehicle can provide covering fire in any direction for a debarking infantry platoon with the hovercraft's short- and long-range missiles, thanks to the fore-and-aft LongFire V racks and brace of SureShot short-ranged missile launchers. The turret mounts a trio of rapid-firing machine guns to deal with hostile infantry.

Deployment

While hovercraft are popular choices for the transporting of troops, the vulnerable hover skirts are often seen as a drawback when in combat conditions. As a result

Maxims, despite their potent fire support for the infantry units they deliver to the battlefield, are often sent away before combat to prevent any unnecessary casualties. Only when the infantry need more fire support do they call the transports back.

During a raid into Free Worlds League space, Capellan soldiers were keen on getting payback for a raid on their home system of Sirius months prior. As the Goblins and infantrymen bogged down the company of BattleMechs, the balance of the infantry's transports, a group of Maxims, made their way around the force and attacked the BattleMechs from behind. Though only a few casualties were inflicted initially, the massed LRM fire spooked the raiders into retreating. The retreat turned into a rout, with the concentrated SRM fire crippling one BattleMech at a time as the panicked raiders left the system.

Variants

Like many other Infantry transports, Maxim variants often just rearrange the weapons for the unit's preference. Some replace the LongFire LRMs with more short-range missile packs, while others re-organize the SRMs, moving the small racks onto the turret.

Notable Crews

Commander Max Cooper: The commander of the guard at MTI's main plant on Sian, Cooper also held significant stock in the company and felt betrayed when news of the scandals broke. He attempted to hold onto the facility as his own during the first few days of the company's dissolution, feeling his stock share was justification enough. His troops, composed of various infantrymen and their Maxim transports, held onto the facility for twelve hours as Hellespont's own corporate militia assaulted him in a "hostile takeover" operation. His forces would later retreat and come back several hours later in an attempt to retake the area, but the swift hovercrafts were no match for the now-entrenched defenders, and Commander Cooper lost his life during the battle.

MAXIM HOVER TRANSPORT

Type: **Maxim Heavy Hover Transport**

Technology Base: Inner Sphere

Movement Type: Hover

Tonnage: 50

Battle Value: 764

Equipment

Internal Structure:

Engine: 165

Type: ICE

Cruising MP: 8

Flank MP: 12

Heat Sinks: 0

Control Equipment:

Mass

5

12

0

2.5

Equipment

Lift Equipment:

Power Amplifier:

Turret:

Armor Factor:

Front

R/L Side

Rear

Turret

88

Armor Value

20

20/20

12

16

Mass

5

0

.5

5.5

Weapons and Ammo

SRM 6

Ammo (SRM) 15

3 Machine Guns

Ammo (MG) 200

2 LRM 5

LRM 5

Ammo (LRM) 24

SRM 2

SRM 2

Ammo (SRM) 50

Infantry Bay

Location

Turret

Body

Turret

Body

Front

Rear

Body

Left

Right

Body

Body

Tonnage

3

1

1.5

1

4

2

1

1

1

1

3

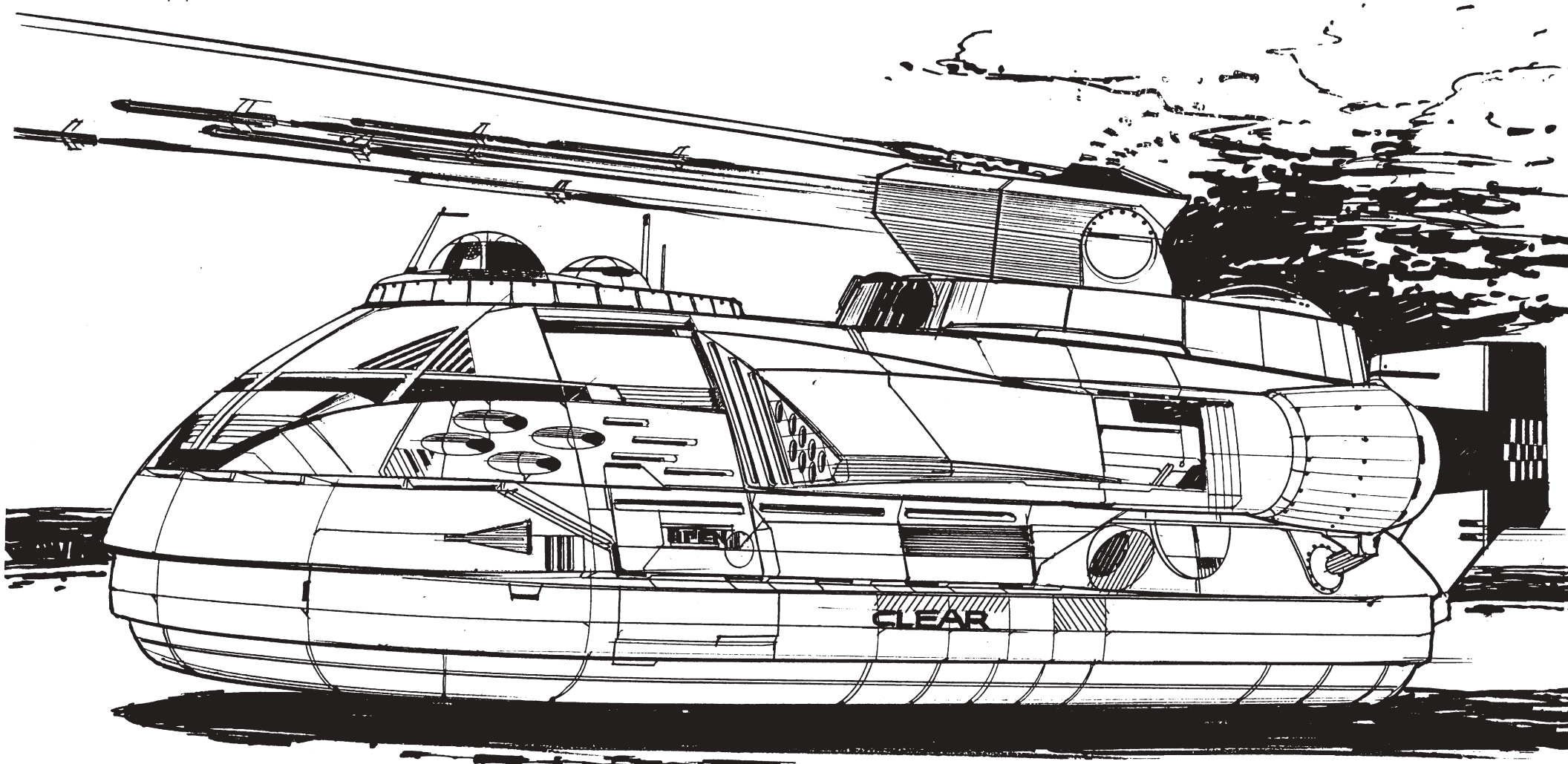

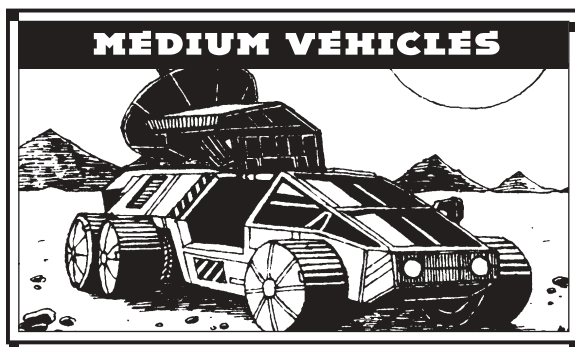

Mass: 50 tons

Movement Type: Tracked

Power Plant: Locom-Pack 250 InterComBust ICE

Cruising Speed: 54 kph

Flank Speed: 86 kph

Armor: ProtecTech 6

Armament:

1 Armstrong J11 Autocannon/5

1 Scatter Gun Light Machine Gun

Manufacturer: New Earth Trading Company

Primary Factory: New Earth

Communications System: ComStar Rover

Targeting and Tracking System: ComStar Test-2

Overview

The Vedette is easily the most popular tank in every Successor State. A solid design, this 50-ton fighting vehicle is often the meterstick against which all other combat vehicles are measured. First produced by the New Earth Trading Company and incorporating specially licensed ComStar electronics, the Vedette has spread to every realm and is in standard production in several factories while also being a common special-license item.

Capabilities

The Vedette is a modern implementation of an ancient medium-tank architecture: a single main cannon and supporting machine gun matched to good speed and armor. The turret-mounted Armstrong J11 Autocannon/5 provides respectable firepower, while a machine gun provides

close-in defense. Both weapons are provided with a satisfactory amount of ammunition.

Six tons of ProtecTech 6 armor clad the Vedette, giving the crew a reasonable amount of protection, but the Vedette's true defense is its impressive 86 kph maximum speed. This speed makes Vedette formations highly mobile, which when combined with the all-terrain nature of its tracked drive system, gives the tank the ability to appear almost at will across the battlefield.

The ComStar-designed electronics are some of the few declassified systems the shadowy organization produces, and they are only found in Vedettes manufactured in the mammoth New Earth Trading Company production facilities on New Earth. Although there are more than a dozen facilities producing Vedettes around the Inner Sphere and local Periphery, those vehicles are forced to rely on locally produced electronics, giving the New Earth vehicles an edge in prestige, if not capabilities.

Deployment

Wherever there are armored vehicles, there will be at least one Vedette. It is not unreasonable to assume there might be an example of this tank on every world in the Inner Sphere. It appears in almost every House armored unit and many mercenary armor battalions. The recent technological renaissance from the memory core recovered on Helm has only helped make the Vedette more popular, allowing more and more manufacturers to begin production. [EDITOR'S NOTE: As of 3055, the Vedette was also being built by Quikscell on Layover, Benson and Bjorn on Ghost Bear-occupied Spittal, Hellestont Industries on Sian, United Outworlders Corporation on Mitchella, Pinard Protectorates Limited on Perdition, and Vandenberg Mechanized Industries on Pinard.]

During the fighting on Drozan in 3030 during the abortive invasion of the Capellan Confederation by the Magistracy of Canopus and the renegade Duchy of Andurien, a large unit of Capellan Vedettes was caught away from prepared defenses. This unit, a short battalion of two reinforced companies, was being pursued by a Canopian 'Mech company. Using their superior mobility, the Vedettes managed to stay ahead of the 'Mech unit by running at flank speed with their turrets cranked around to

face rearward. The Vedettes kept the 'Mechs under a near-constant barrage of cannon fire and managed to disable or destroy three heavy Canopian 'Mechs. Unfortunately, they weren't able to disengage before they ran out of ammunition and were later routed, but the damage they inflicted kept the Canopian 'Mech company out of action for three months.

Variants

Two main variants have emerged over the years. The first variant is meant to extend the Vedette's range. The Armstrong autocannon is replaced with a lighter cannon and adds a supplementary short-range missile rack. The second, popular in Liao space, removes the Armstrong and replaces it with two medium lasers and six heat sinks. With the Vedette being so common, the variants that might be encountered on battlefields are nearly endless.

Notable Crews

Leftenant Karl Noonan: Leftenant Noonan and his Vedette crew were last seen in the Fire Rift area of Quentin during the War of 3039. Noonan and his crew were forced to retreat alone after the Fortieth Dieron Regulars overran their vehicle company. Captured reports seem to indicate that the Vedette was still operational and using the high IR and magnetic anomaly content of the Fire Rift to keep ahead of their Kuritan pursuers at least into mid-3040. How they held out so long without military resupply of fuel and ammunition is credited to the Davion citizens, who fought the Kurita invasion with a lively and effective underground resistance.

Subcommander Liu Soon: Commander of a small urban defense unit, Subcommander Liu has equipped his entire company with the medium-laser variant Vedette. This unit exercises constantly, training to ambush enemy 'Mechs and vehicles in the close confines of an urban landscape. A veteran of both the Fourth Succession War and the Andurien-Magistracy invasion, Subcommander Liu is fervent believer in using all available cover to make an invader pay.

VEDETTE MEDIUM TANK

Type: **Vedette Medium Tank**
 Technology Base: Inner Sphere
 Movement Type: Tracked
 Tonnage: 50
 Battle Value: 475

Equipment	Mass
Internal Structure:	5
Engine:	250
Type:	ICE
Cruising MP:	5
Flank MP:	8
Heat Sinks:	0
Control Equipment:	2.5
Lift Equipment:	0
Power Amplifier:	0

Equipment	Mass
Turret:	1
Armor Factor:	96
	<i>Armor Value</i>
Front	20
R/L Side	18/18
Rear	20
Turret	20

Weapons and Ammo	Location	Tonnage
AC/5	Turret	8
Ammo (AC) 20	Body	1
Machine Gun	Turret	.5
Ammo (MG) 100	Body	.5

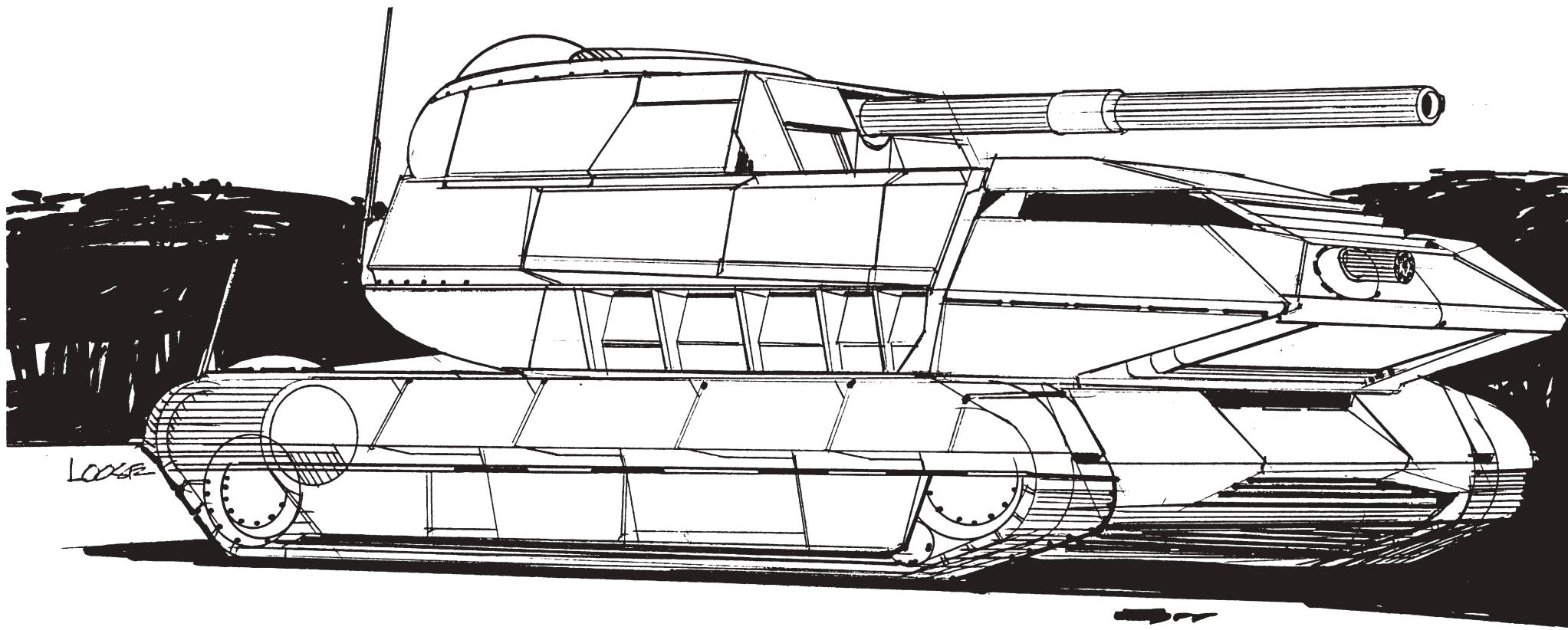

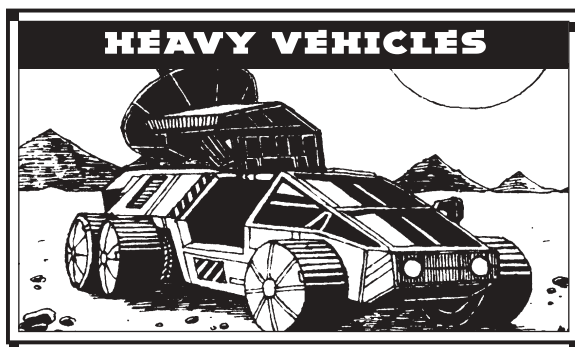

Mass: 60 tons

Movement Type: Tracked

Power Plant: Bulldog 240 ICE

Cruising Speed: 43 kph

Flank Speed: 64 kph

Armor: Bulldog Standard

Armament:

1 Bulldog Large Laser

2 Hovertec Quad SRM 4 Systems

1 Bulldog Minigun Machine Gun

Manufacturer: Bulldog Enterprises, Quikscell Company

Primary Factory: Proserpina (Bulldog),
Ares (Quikscell)

Communications System: Xilex-2000

Targeting and Tracking System: Xilex-2000

Overview

A successful producer of civilian vehicles, Bulldog Enterprises attempted to expand into a new market when the Star League Defense Force ramped up. Its first attempt, the Bulldog Medium Tank, was meant to be a relatively low-cost, mass-produced design, able to be fielded in battalion and regimental formations in campaigns without straining the logistical chain. Unfortunately, its reception was not as good as anticipated, and in 2700 Bulldog Enterprises licensed the tank to Quikscell in hopes the royalties from sales on the other side of the Inner Sphere could fund the design of more popular military vehicles.

Capabilities

Though effective, the Bulldog's armament and armor are both uninspired. A single large laser backed by a pair of Hovertec SRM 4s gives the tank considerable throw-weight at short range, especially against other vehicles. Like most other vehicles, a single front-mounted machine gun is the standard anti-infantry defense, though some may augment this by making half of the SRM ammunition infernos.

The advantage of such an average design is that Bulldogs rarely go without spare parts, allowing technicians to repair and rebuild the machine. Many Bulldogs abandoned on the battlefield as unsalvageable reappear within the ranks of the opposing force a few days later.

Deployment

Despite the vehicle's slow start, hundreds of thousands of Bulldogs have been produced since its introduction, and they have spread to all corners of the Inner Sphere. Though this may sound impressive, many other conventional vehicles in its class have had double or triple the Bulldog's production numbers, demonstrating the lukewarm reception it has had.

Much of the Bulldog's sales were attributed to its low cost. For example, House Davion selected the Bulldog for its war stockpiles in anticipation of the Succession Wars simply because the tank was inexpensive. With sales from the Draconis Combine and Capellan Confederation blocked during the Succession Wars, the AFFS had to draw from that stockpile to replace its combat losses, sometimes battalions at a time. This supply was exhausted by the middle of the Third Succession War, but the remaining Bulldogs were readily maintained due to their ability to accept a wide range of replacement components.

After the Fourth Succession War, Davion raiders struck Ares periodically. By this time, most of the Capellan Confederation's defenders had become so demoralized that shipments of assembled Bulldogs and other conventional vehicles were easy pickings, allowing raiders to come away with several battalions of military vehicles, especially Bulldogs. As long as the raiders stayed away from the BattleMech and DropShip facilities in the system, the only resistance expected was the small corporate militia defending the Quikscell site.

In 3035, Hansen's Roughriders jumped through the Free Rasalhague Republic to attack the Combine world Sternwerde in a campaign that would inspire the Killer Bees' operation during the War of 3039. Defending the system were the Fifth Benjamin Regulars and a battalion of the Elite Second Sword of Light. The Kurita defenders attempted a delaying action, while several other regiments with armor and infantry support jumped in system to trap and destroy the unit. However, the Roughriders were able to keep the defenders at bay until the Kuritan reinforcements arrived. Instead of retreating in the face of such overwhelming odds, the Roughriders ambushed the landing zone and caught the three DCMS regiments as they were unloading. The Combine regiments were slaughtered, often caught in the DropShips being destroyed around them. With this victory in their hat, the exhausted Roughriders retreated to Lyran space.

The unit that would earn the most kills in that final battle was not any BattleMech, but a lone Bulldog tank named Little Softy, which garnered five BattleMech kills, almost forty vehicle kills, and several hundred infantrymen killed or wounded. Most of these kills were credited to Little Softy's use of infernos, which were fired into the exposed cargo bay of an unloading DropShip. The ammunition stockpiled there detonated, destroying the DropShip and numerous units unable to descend the packed loading ramps.

Variants

Since large Bulldog units are common, some have been modified to provide organic fire support. Common variants either replace the large laser with an LRM 20 or a pair of AC/2s for those who prefer more direct forms of fire support.

Notable Crews

Major Jake Blanchard: Commander of the Second Armored Battalion within the mercenary unit Hansen's Roughriders, Major Blanchard often keeps his Bulldog, Little Softy, and his battalion near the main formation of Roughrider BattleMechs, where they can provide stalwart support for the 'Mechs.

BULLDOG MEDIUM TANK

Type: **Bulldog Medium Tank**
 Technology Base: Inner Sphere
 Movement Type: Tracked
 Tonnage: 60
 Battle Value: 605

Equipment	Mass
Internal Structure:	6
Engine:	23
Type:	ICE
Cruising MP:	4
Flank MP:	6
Heat Sinks:	8
Control Equipment:	3
Lift Equipment:	0
Power Amplifier:	.5
Turret:	1

Equipment	Armor Value	Mass
Armor Factor:	104	6.5
Front	24	
R/L Side	20/20	
Rear	20	
Turret	20	

Weapons and Ammo	Location	Tonnage
Large Laser	Turret	5
2 SRM 4	Turret	4
Ammo (SRM) 50	Body	2
Machine Gun	Front	.5
Ammo (MG) 100	Body	.5

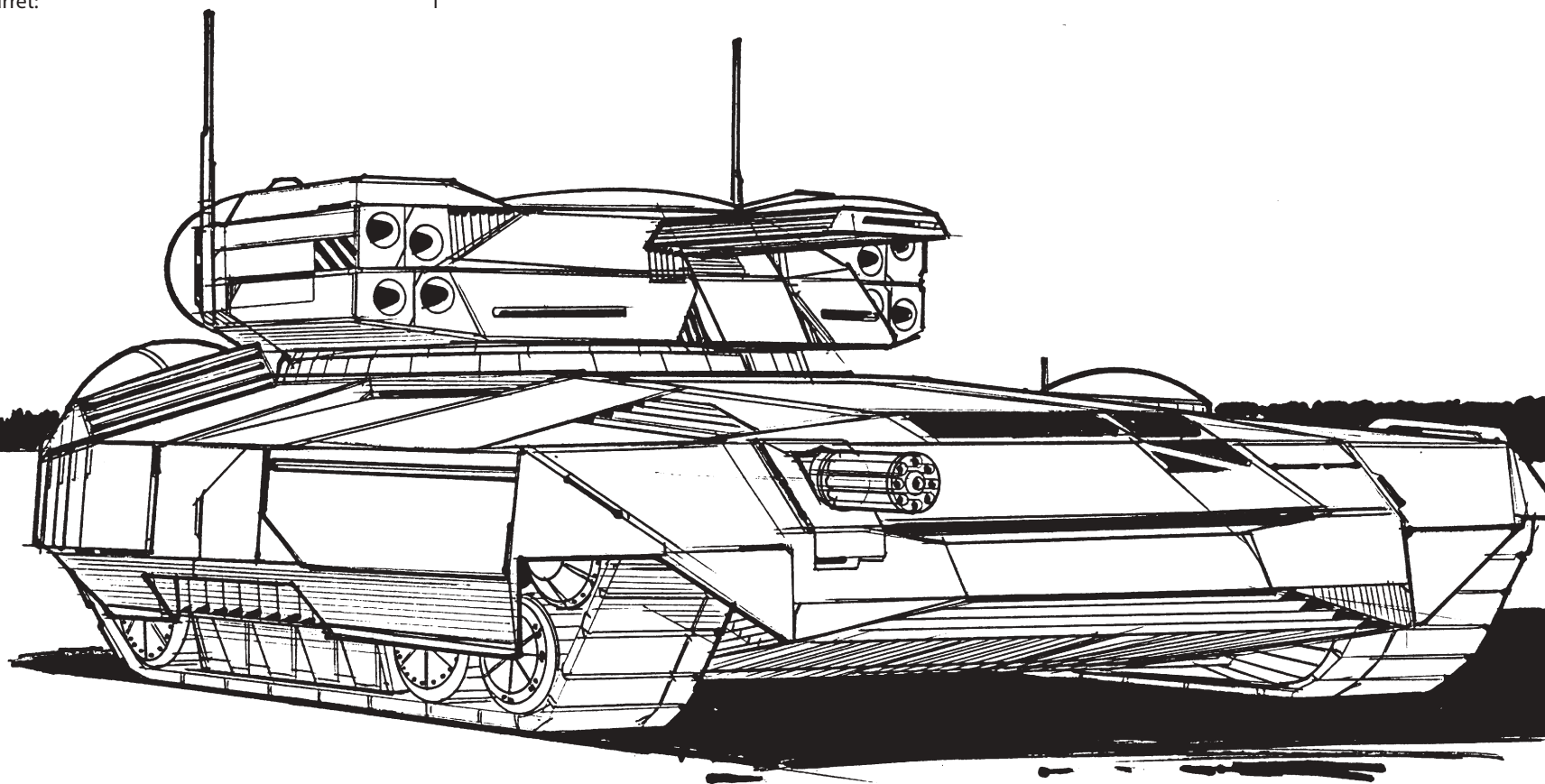

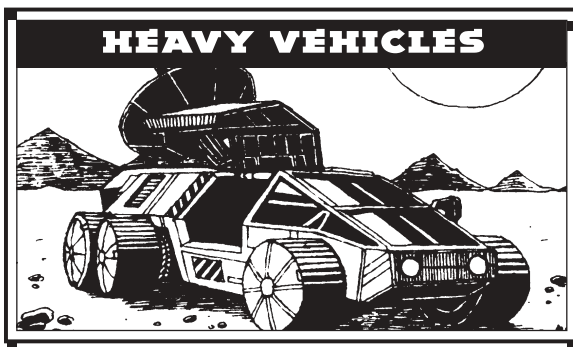

Mass: 60 tons

Movement Type: Tracked

Power Plant: Vlar 240 ICE

Cruising Speed: 43 kph

Flank Speed: 64 kph

Armor: ArcShield V

Armament:

1 SureShot II SRM 2

Manufacturer: ScolTek Associates

Primary Factory: Inarcs

Communications System: StealthMat-Q with Multitrack

Targeting and Tracking System: Tar Tec Mini-Find

Overview

A Succession Wars-era low-cost answer to the increasing need for dedicated reconnaissance units, the Hi-Scout Drone Carrier debuted in the year 3000, produced for the Lyrans Commonwealth by ScolTek Associates of Inarcs. Though lacking the sophisticated electronics found during the Star League era, the effectiveness of the Hi-Scout and its remote-controlled drones nevertheless offered a better solution to the hazards of sending fast, light 'Mechs into suspect territory during an age when BattleMechs were growing frighteningly rare. In short order, the other

Successor States came to copy ScolTek's design, leading to a widespread use of these vehicles among the Inner Sphere's more well-equipped regiments.

Capabilities

In the scavenger tech age of the late Third Succession War, the Hi-Scout quickly earned the reputation as the best detection unit available. The Hi-Scout's own sensor suite includes infrared, seismic, audio, motion, radio (including hyperpulse signals), and radar. With its StealthMat-Q Communications System, the drone carrier could coordinate with its unmanned probes to find and identify enemy units without being detected itself. Its communications radius (without satellite assistance) to its drones is twenty-five kilometers, which could be daisy-chained through a series of drones acting as relays to more distant siblings. Its standard NapFind and PathTrack Sensor Drones—essentially remote-controlled mini-vehicles designed to relay signals back to the command unit—used some of the most complex communications equipment available to the Inner Sphere militaries of the day. Only the enhanced electronics of the Star League-era, such as the Beagle Active Probe and the Guardian ECM Suite, could improve on the reconnaissance capabilities of the Hi-Scout and its drones.

The NapFind drone, a 2,500-kilogram remote-controlled hovercraft, employed an advanced "venturi-disk" skirtless hover system for mobility and could attain speeds nearing 250 kilometers per hour using its fuel cell-based engine. Armed only with a pair of manipulators (used most often in demolitions work or for military scientific analysis and hazmat handling situations), the NapFind could cruise away from its parent unit—often as far away as 30 to 50 kilometers—and gather a host of data through its standard sensor array, relaying its findings through the remote connection.

The PathTrack, a slightly heavier tracked drone similar in basic design to the NapFind, boasted a longer operating range and somewhat more powerful detection systems, as

well as a modicum of armor protection useful against collisions and small-arms fire. The PathTrack has all the detection capabilities of the NapFind while also being adept at intercepting radio transmissions, which it then could relay back to the Hi-Scout through the drone command system.

The Hi-Scout itself formed the centerpiece of the network and thus was built with a sturdier design and armed to discourage hostile infantry and light vehicles. Its communications network could transmit over numerous different channels at once and coordinate the activities of all five of its drones at the same time.

Deployment

A broad range of copycat vehicles emerged after the first LCAF Hi-Scouts were captured in a Kurita raid, and scores of company-made Hi-Scouts were smuggled out through various intermediaries posing as mercenary buyers. As a result, within less than twenty years, nearly all five of the Great Houses possessed Hi-Scout drone networks or effective knock-offs using a similar design. Though the LIC was eventually able to plug the security breaches that made this proliferation possible, by 3025 any strategic advantage ScolTek's innovation provided House Steiner had long since evaporated.

Variants

No significant variants of the Hi-Scout or its drones emerged in the years prior to the War of 3039, though the recovery of Star League technology placed the design on the table for numerous experimental modifications. By far the most promising were those of the Capellan Confederation, which sought to implement Beagle Active Probes and Guardian ECM technology in the ScolTek designs. Unfortunately, engineering limitations—not the least of which included the sheer weight of the advanced sensors—forced the Confederation's engineers to reinvest their efforts in the design of heavier, dedicated scout units like the *Raven*.

PATHTRACK

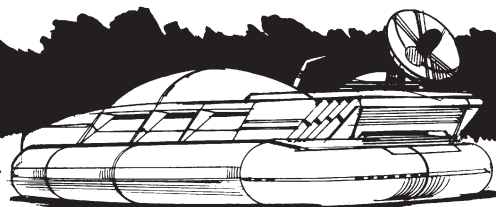
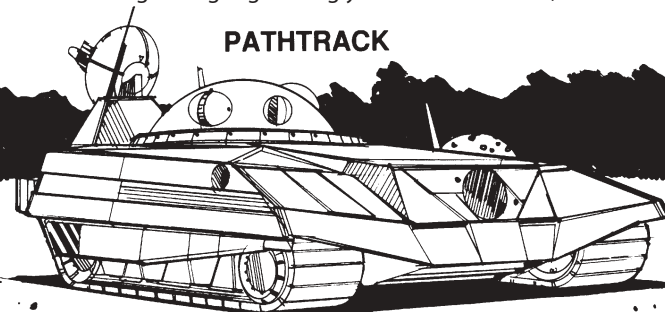

NAPFIND

HI-SCOUT DRONE CARRIER

Type: **Hi-Scout Drone Carrier**
 Technology Base: Inner Sphere
 Movement Type: Tracked
 Tonnage: 60
 Battle Value: N/A

Equipment		Mass
Internal Structure:		6
Engine:	240	23
Type:	ICE	
Cruising MP:	4	
Flank MP:	6	
Heat Sinks:	0	0
Control Equipment:		3
Lift Equipment:		0
Power Amplifier:		0
Turret:		.5
Armor Factor:	88	5.5
	<i>Armor Value</i>	
Front	18	
R/L Side	18/18	
Rear	16	
Turret	18	

Weapons and Ammo	Location	Tonnage
SRM 2	Turret	1
Ammo (SRM) 50	Body	1
Drone Carrier Control System	Body	4.5
3 Tracked Drones	Body	9
2 Hover Drones	Body	5
Cargo	Body	1.5

Type: **Tracked Drone (PathTrack)**
 Chassis Type: Tracked (Small Remote Drone)
 Mass: 3,000 kg
 Technology Base: Inner Sphere (D/X-F-D/C)
 Battle Value: N/A

Equipment		Mass
Chassis/Controls:		195 kg
Engine:	ICE	1,836 kg
Cruising MP:	8	
Flank MP:	12	
Fuel:	354 km (Petrochemical)	65 kg
Control Systems:	Drone	800 kg
Power Amplifier:		0
Turret:		0
Armor Factor (BAR 2):	8	104 kg
	<i>Armor Value</i>	
Front	2	
R/L Side	2/2	
Rear	2	

Weapons and Ammo	Location	Mass
None	—	—

Crew: 0
Note: Features Ultra-Light Chassis Modification and Drone (Remote) Operating System

Type: **Hover Drone (NapFind)**
 Chassis Type: Hover (Small Remote Drone)
 Mass: 2,500 kg
 Technology Base: Inner Sphere (D/X-F-D/C)
 Battle Value: N/A

Equipment		Mass
Chassis/Controls:		250 kg
Engine:	Fuel Cell	1,432 kg
Cruising MP:	15	
Flank MP:	23	
Fuel:	153 km	33 kg
Control Systems:	Drone	750 kg
Power Amplifier:		0
Turret:		0
Armor Factor (BAR 2):	0	0
	<i>Armor Value</i>	
Front	0	
R/L Side	0/0	
Rear	0	

Weapons and Ammo	Location	Mass
2 Manipulators	Front	20 kg

Crew: 0
Cargo: 15 kg (Front)
Note: Features Ultra-Light Chassis Modification and Drone (Remote) Operating System

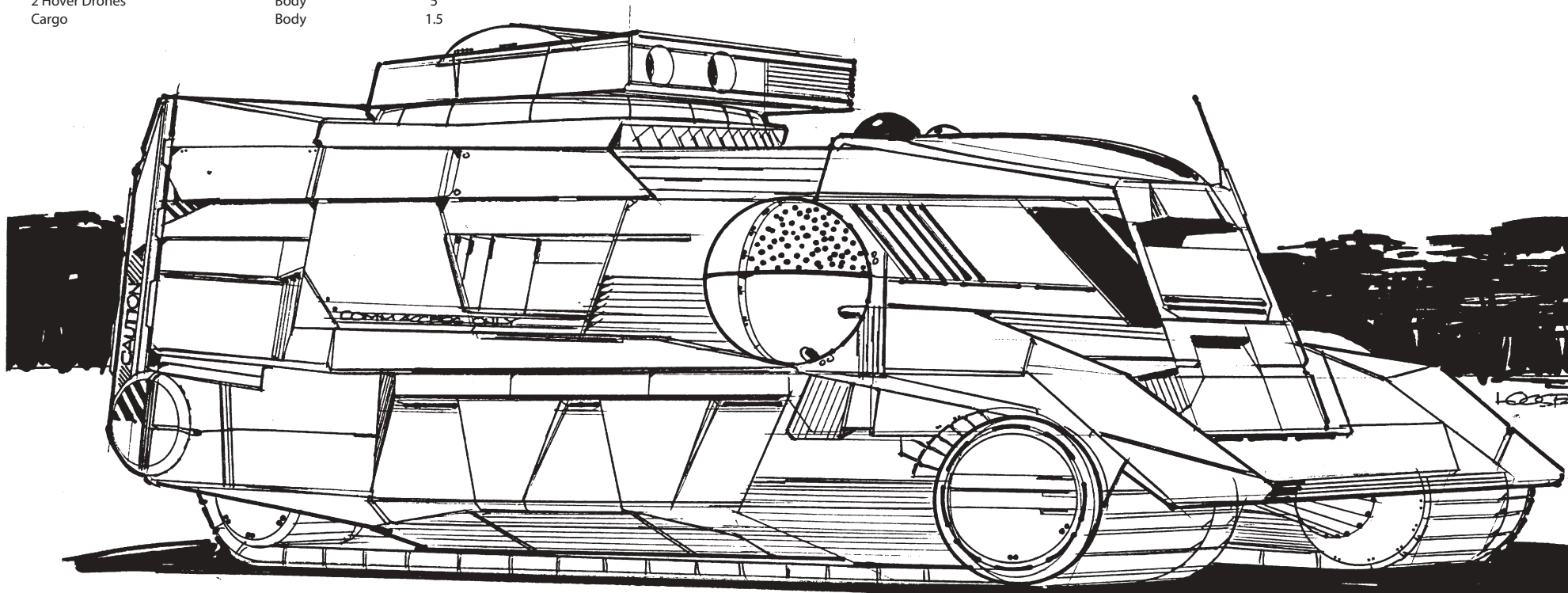

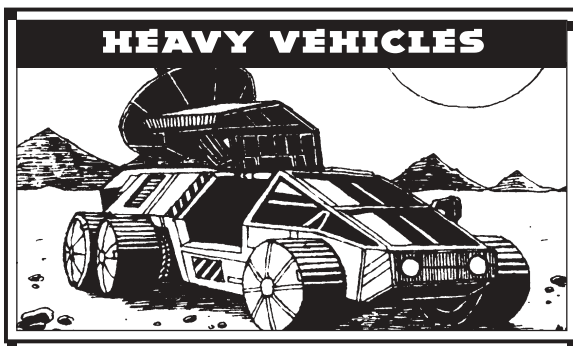

Mass: 60 tons
Movement Type: Tracked
Power Plant: InterComBust 180 ICE
Cruising Speed: 32 kph
Flank Speed: 54 kph
Armor: Simple Armor Plate Standard
Armament:

- 3 FarFire LRM 20 (LRM Carrier)
- 10 Holly SRM 6 (SRM Carrier)

Manufacturer: Aldis Industries, Joint Equipment Systems, Quikscell Company
Primary Factory: Terra (Aldis), Alshain (JES), various (Quikscell)

Communications System: Communicator
Targeting and Tracking System: FireScan with IndirecTrack

SRM CARRIER

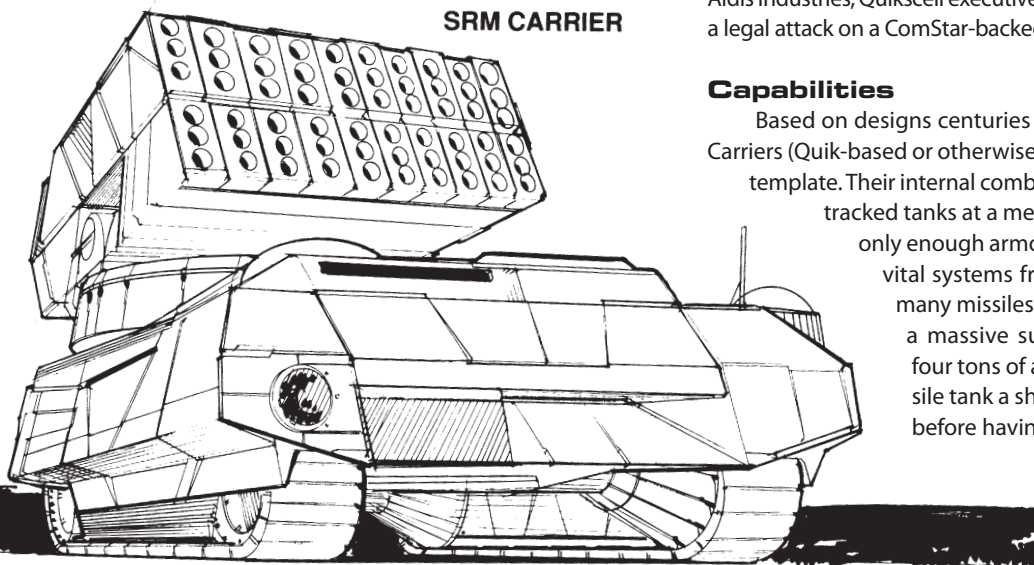

Overview

Unveiled during the Age of War by Quik Products Inc. (the predecessor of Quikscell), the generically named Missile Carriers quickly became highly coveted due to their massive firepower. Many other companies released poorly built clones of Quik's design, leading to bad publicity for the growing company as these copies often broke down or did not work in the first place (even more so than Quik's products).

Shortly before the Fourth Succession War, Quikscell launched a series of lawsuits against the various other manufacturers who copied their missile carriers. The lawsuits were considered almost frivolous by industry watchers, who did not understand that Quikscell was not targeting every model of missile support vehicle, but rather the Missile Carriers closely based on the original design of Quik Products, Inc. There were, in fact, many manufacturers that had been frightened by the Succession Wars' technological regression into religiously adhering to the Quik Products design in most details, which made the unusual intellectual property case feasible.

Many of these producers' sole products were these cheap Missile Carriers, and the high legal costs forced them to either cease production or to go out of business (usually both). One company not targeted by the legal attacks was Joint Equipment Systems, which was the only company to negotiate in good faith with Quik Products Inc. centuries before. When faced with the emergence of the Com Guards and another manufacturer of the Quik-designed Missile Carrier, Aldis Industries, Quikscell executives refrained from launching a legal attack on a ComStar-backed, Terran-based company.

Capabilities

Based on designs centuries older, the current Missile Carriers (Quik-based or otherwise) follow roughly the same template. Their internal combustion engines propel the tracked tanks at a mediocre 54 kph and mount only enough armor to protect the crew and vital systems from the back blasts of so many missiles. Sixty missile tubes make a massive support battery, but only four tons of ammunition give the missile tank a short battlefield endurance before having to retire for re-supply.

To make the missile carriers more attractive to a wide variety of customers, the launching systems are designed to easily use a wide variety of other manufacturer's missile ammunition. For example, Davion troops may load an LRM carrier with DeltaDart munitions, while their Kuritian counterparts use Shigunga versions. The sole caveat to this trend is that Quikscell does not warranty vehicles that malfunction when loaded with missile munitions other than their FarFire/Holly launchers.

Deployment

Due to Quikscell's multiple plants scattered across the Inner Sphere, every majority military fields LRM/SRM Carriers in significant numbers. Quikscell wisely offered a trade-in program to all using LRM/SRM Carriers not produced by them with some free spare parts tossed in for good measure, and by the end of the War of 3039 only a handful of the non-Quikscell-designed carriers remained, mainly in the hands of pirate groups or periphery planets too poor to pay the shipping expenses.

Variants

Though a few units attempted to replace the missile systems with other weapon systems such as lasers or AC/2s, none were popular or as effective as the original. Most of these changes were simply to streamline logistics for the unit or to take advantage of large stockpiles of otherwise unused munitions.

Notable Crews

Jerry Rogers: A member of a pirate band known for raiding the Outback systems of the Federated Suns, Rogers' last known action was on the system of Estuan in 3029. A food raid turned bad, leaving much of Rogers' group wiped out. Rogers and his lone SRM Carrier were pursued by a group of equally slow BattleMechs and infantrymen into the middle of Estuan's capital city. When the pursuit finally caught up to the carrier, it was seemingly abandoned. They encircled the vehicle only to be caught by the blast of small explosive device that set off the remaining missile munitions, leveling the surrounding civilian buildings and killing the pursuing force. Despite having a huge bounty on his head after that, Jerry Rogers has never been seen again.

LRM/SRM CARRIER

Type: LRM Carrier

Technology Base: Inner Sphere
 Movement Type: Tracked
 Tonnage: 60
 Battle Value: 833

Equipment

Internal Structure:		6
Engine:	180	14
Type:	ICE	
Cruising MP:	3	
Flank MP:	5	
Heat Sinks:	0	0
Control Equipment:		3
Lift Equipment:		0
Power Amplifier:		0
Turret:		0
Armor Factor:	48	3
	<i>Armor Value</i>	
Front	12	
R/L Side	12/12	
Rear	12	

Weapons and Ammo

	Location	Tonnage
3 LRM 20	Front	30
Ammo (LRM) 24	Body	4

Type: SRM Carrier

Technology Base: Inner Sphere
 Movement Type: Tracked
 Tonnage: 60
 Battle Value: 816

Equipment

Internal Structure:		6
Engine:	180	24
Type:	ICE	
Cruising MP:	3	
Flank MP:	5	
Heat Sinks:	0	0
Control Equipment:		3
Lift Equipment:		0
Power Amplifier:		0
Turret:		0

Equipment

Armor Factor:	48	Mass	3
	<i>Armor Value</i>		
Front	12		
R/L Side	12/12		
Rear	12		

Weapons and Ammo

	Location	Tonnage
10 SRM 6	Front	30
Ammo (SRM) 60	Body	4

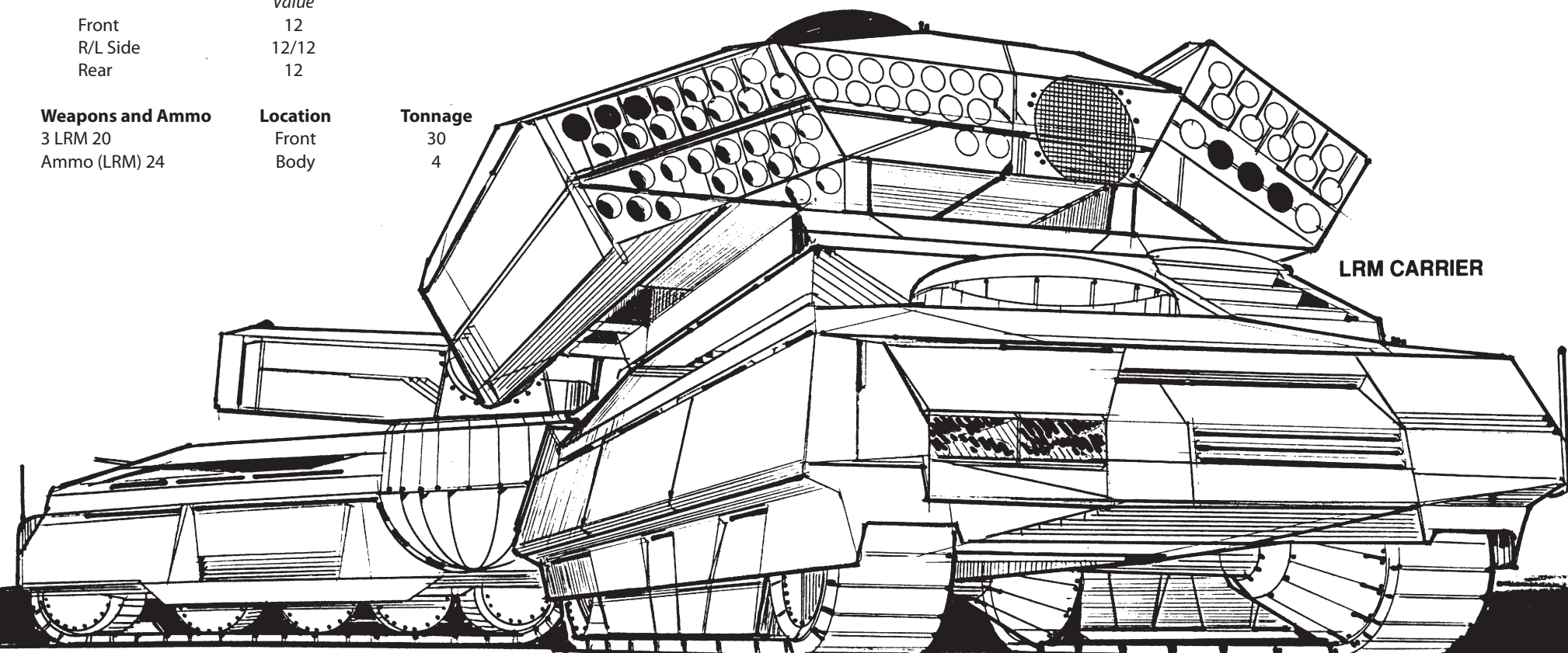

LRM CARRIER

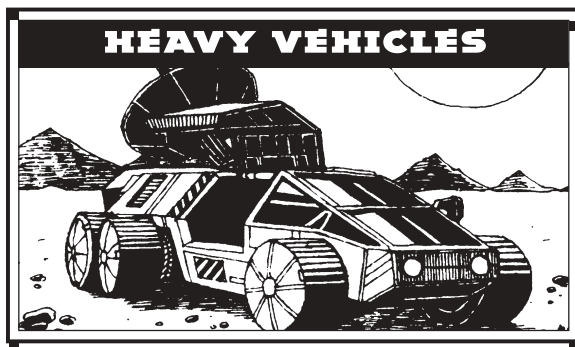

Mass: 60 tons

Movement Type: Tracked

Power Plant: Pitban 240 Fusion

Cruising Speed: 43 kph

Flank Speed: 65 kph

Armor: ArcShield Maxi II

Armament:

1 Parti-Kill Heavy Cannon PPC

1 SureShot Mk VI SRM 6

1 FarFire LRM 10

1 OMI HighBurn Medium Laser

Manufacturer: Defiance Industries, Jalastar Aerospace

Primary Factory: Hesperus II (Defiance),
Panpour (Jalastar)

Communications System: O/P R Janxiir

Targeting and Tracking System: TargiTrack 717

Overview

For its time, the Manticore was a state-of-the-art frontline heavy tank, originally intended to be a one-on-one match for BattleMechs of equal size. It was designed by TechniCorp for the Star League member states and earned a reputation as a powerful infantry-support weapon during the Reunification War. With the destruction of TechniCorp's head offices on Terra during the Amaris Coup, other weapon manufacturers absorbed TechniCorp's production plants across the Inner Sphere. It is a testament to TechniCorp's solid design that the Manticore is presently produced by no less than six manufacturers, nearly five centuries after its inception.

Capabilities

The Manticore was designed similarly to BattleMechs of the time, with a wide variety of weapons to give it the ability to fight at several range brackets. The Parti-Kill PPC and FarFire LRM do considerable damage to units at long range, while the short-ranged missiles and a front-mounted OMI medium laser protects the tank at close quarters. Many Manticore crews will attempt to close within 300 meters of a target, allowing a Manticore to unleash all its weapons.

The key to the Manticore's superior capabilities is its 240-rated Pitban Fusion engine. Fusion engines were typically the province of BattleMechs during the Succession Wars, which left most combat vehicles with heavier and more traditional internal combustion engine. The advantages of fusion engines are evident on the Manticore, allowing the tank to move at a respectable cruise speed of 43 kph and keep its internals protected with eleven tons of armor. While sounding average when compared to BattleMechs, it is considerably better than other vehicles in its weight class.

Unlike other PPCs, the Parti-Kill uses a series of magnetic collection bottles that collect a charge of plasma. These energies are then released as an energy "shell" that is unstable at ranges of less than ninety meters and loses cohesion and disintegrates at 540 meters.

However, despite (or because of) its wide range of weapons, Manticore crews are taught to avoid the heavy brawlers such as the Behemoth and Ontos, as the Manticore does not have the same raw firepower as those super-heavy tanks.

Deployment

The distinguished, high profile of the Manticore, selected to give it good angles of fire against towering BattleMechs, makes it easily spotted on the battlefield, for better or for worse. Though more expensive than other frontline tanks such as the Bulldog, it is very common to see entire companies and battalions composed of Manticores. Many wealthy nobles who are just shy of being able to afford a BattleMech formation will often pay for

Manticores rather than any other conventional ground vehicle. Licensing the vehicle to other companies has spread the Manticore's reputation to the farthest corners in the Inner Sphere and parts of the Periphery.

Many have questioned Defiance Industries' decision to aid the Commonwealth's ancient enemy, the Draconis Combine, in starting Manticore production on Proserpina. However, Defiance Industries has defended itself by showing that the Combine weapons manufacturer, Bulldog Enterprises, was attempting to clone the vehicle for House Kurita anyway, so it was better for the Commonwealth to squeeze every penny out of the design and keep the proceeds local.

Variants

Defiance Industries decided to continue TechniCorp's policy of refusing repairs on modified Manticore tanks. One leniency in this policy is that customers are allowed to use different brands of the mounted weapons if necessary due to combat damage. The extensive discount on the repairs has most customers willingly complying. Other Manticore manufacturers followed similar policies, at least until the technological recovery of the 3030s and 3040s encouraged experimentation.

Notable Vehicles

BlackWater: The Manticore tank nicknamed BlackWater was crewed by a group of Dispossessed Davion MechWarriors who pooled their funds to buy the tank so as to not be transferred to desk jobs or drummed out of the military. During the lopsided fighting in the Fourth Succession War, each crewmember was able to salvage a new BattleMech. As the last 'Mech was captured, the crew decided to scrap the Manticore for various weapons, armor, and engine parts to bring their 'Mechs up to fighting condition. By the end, all that was left was the chassis, motive system, and some incompatible circuit boards. However, during the War of 3039, these same former crewmen (assigned to the same lance) all lost their new 'Mechs. The few salvageable parts of their 'Mechs were, coincidentally, mostly from BlackWater.

MANTICORE HEAVY TANK

Type: **Manticore Heavy Tank**
 Technology Base: Inner Sphere
 Movement Type: Tracked
 Tonnage: 60
 Battle Value: 933

Equipment		Mass
Internal Structure:		6
Engine:	240	17.5
Type:	Fusion	
Cruising MP:	4	
Flank MP:	6	
Heat Sinks:	13	3
Control Equipment:		3
Lift Equipment:		0
Power Amplifier:		0
Turret:		1.5

Equipment		Mass
Armor Factor:	176	11
	<i>Armor Value</i>	
Front	42	
R/L Side	33/33	
Rear	26	
Turret	42	

Weapons and Ammo	Location	Tonnage
PPC	Turret	7
SRM 6	Turret	3
Ammo (SRM) 15	Body	1
LRM 10	Turret	5
Ammo (LRM) 12	Body	1
Medium Laser	Front	1

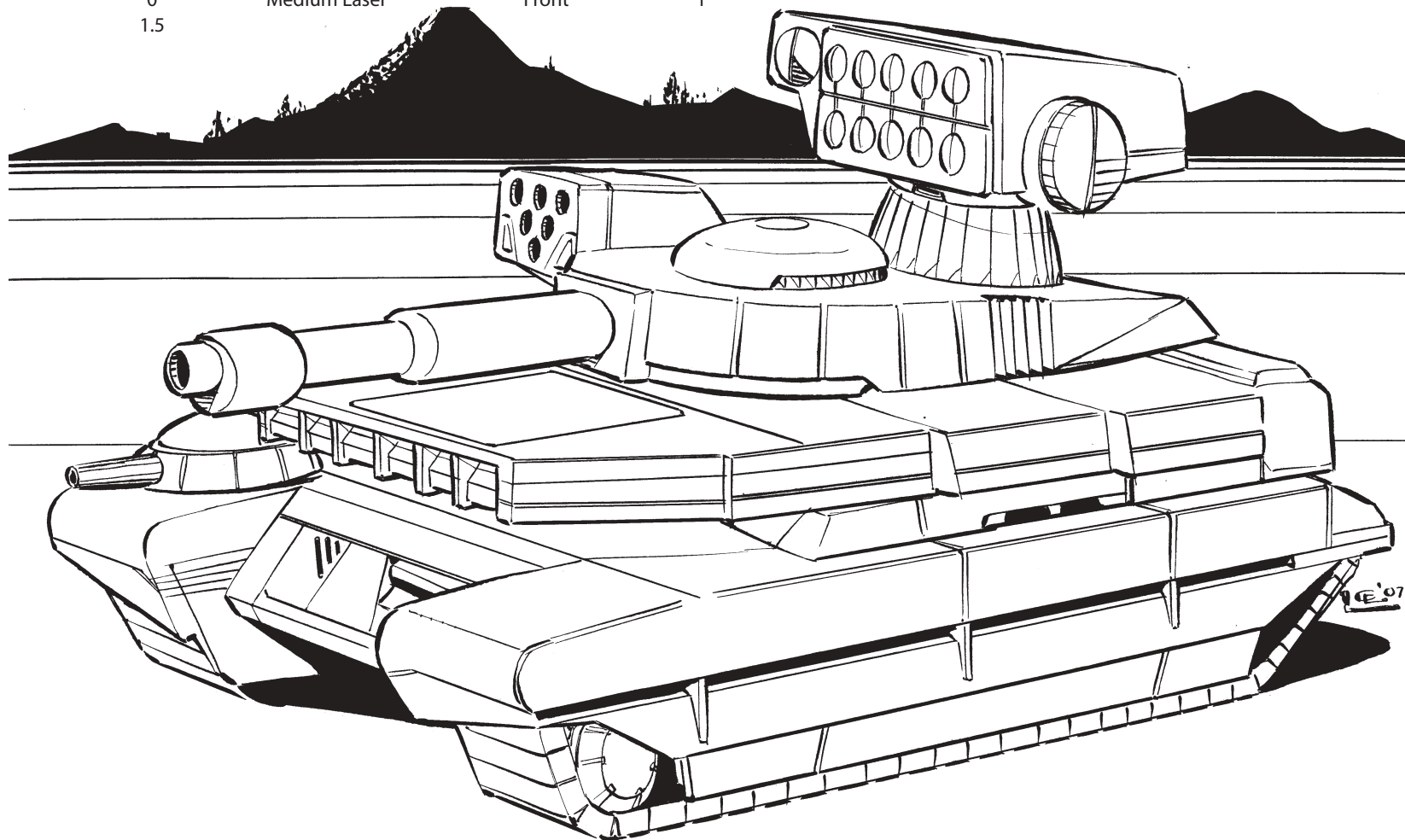

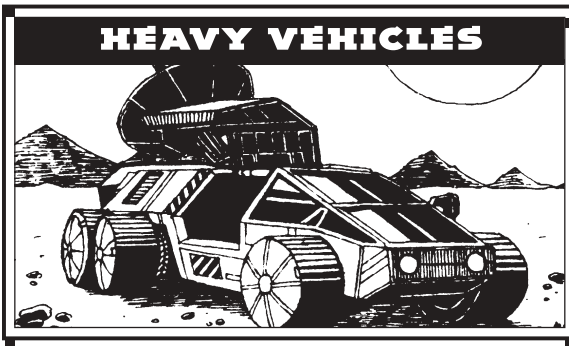

Mass: 60 tons

Movement Type: Tracked

Power Plant: Jones 180 with EmissionKill ICE

Cruising Speed: 32 kph

Flank Speed: 54 kph

Armor: StarSlab/9

Armament:

3 ZeusBolt Autocannon/2s

2 Marklin Mini Missile SRM 2 Packs

Manufacturer: Canopus Industries Alpha

Primary Factory: Canopus

Communications System: Magestrix Alpha

Targeting and Tracking System: Magestrix Gamma

Overview

The Pike Support Vehicle was an attempt by Magestrix Kyalla Centrella to take advantage of the endless battles of the Third Succession War—and the endless attrition in 'Mechs those battles caused—by marketing an inexpensive combat vehicle to the Successor States to replace the shrinking BattleMech forces. Her hope was that by continuing to support military conflict in the Inner Sphere, the Successor Lords would wear themselves down while the Magistracy preserved its own BattleMechs. The Magestrix underestimated the logistics of shipping useful quantities of military vehicles to the Inner Sphere to achieve that end, overlooking the success the House Lords had achieved in wearing down their JumpShip fleets. Despite slow sales caused by the poor shipping situation, the legacy of the

Pike is one that transcends its origins and earns it a place in the annals of combat vehicles.

Capabilities

The Pike is not a fast tank, nor a particularly well-armed or -armored tank. It doesn't have a flashy profile or come from a famous factory. In fact, most consider its Periphery origins a liability. It's not powered by a high-tech fusion engine and it doesn't use state-of-the-art ComStar electronics. What the Pike has is reliability.

Considering its origins, the Pike is actually a rather innovative vehicle. The EmissionKill system attached to the Jones 180 ICE attempts to mask the tank's infrared signature with limited success, and the Magestrix Gamma targeting and tracking system uses an innovative radar system to correct the fire of the trio of ZeusBolt Autocannon/2s. And while the cannons don't cause a catastrophic amount of damage per round, there are three of them. A pair of short-range missile racks protects the Pike from enemies that close within the minimum range of the ZeusBolts.

Deployment

To date the largest purchaser of the Pike has been ComStar, who uses the tank to reinforce the garrisons of a number of smaller hyperpulse facilities around the Inner Sphere and nearby Periphery. After a spectacular engagement against Helmar Valasek's pirates near Santander V, ComStar ordered the next four years of production from the Pike lines and spread them around the Inner Sphere.

Because of the weak firepower of a single Pike, ComStar takes advantage of its unique organizational scheme, which uses a base six rather than base four, to group five Pikes with a single Demolisher Heavy Tank. Three ZeusBolt cannons are just an annoyance to a BattleMech, but fifteen of them firing at one target can quickly destroy even the largest BattleMech. Since the simplest tactic when faced with light autocannon fire is to charge in beneath the guns' minimum range, ComStar planners place a short-ranged Demolisher tank with the group to protect it at ranges less than 120 meters.

Variants

Canopus Industries Alpha produces no variants of the basic Pike chassis. With the frame in continuous production for almost eighty years, however, a number of one-of-kind field modifications are sure to exist. Various configurations of missiles or larger-bore cannons are most common.

Notable Crews

Commander Theo Lykins: Commander Lykins is a member of one of the domestic Pike units in the Magistracy Armed Forces. As one of the primary defensive formations for the factories that produce the Pike—and a number of other critical vehicles—both for the MAF and for export, Lykins' unit is intimately familiar with the Pike's strengths and flaws. Lykins' double-strength company of twenty-four Pikes is the first line of defense against any attacker approaching the factory complex. A series of specially built revetments allow the Pikes to go hull-down, hiding all except their turrets, and fire into specially cleared lanes that any attacker is forced to travel down. The rest of his battalion—a dozen Hetzer Wheeled Assault Guns—remain in cover, ready to attack at close range any invader who manages to breach the Pikes' "Wall of Fire."

Adept IV Carla Rush: Adept Rush commands a special detachment—two Level II formations—of Pikes and Demolishers stationed at one of ComStar's Periphery HPGs. Deployed on the capital world of the Oberon Confederation near the court of Bandit King Hendrik Grimm, Adept Rush and her vehicles were a highly visible reminder of ComStar's military might. During exercises with the local Oberon Guards, Adept Rush's command proved highly adept at spotting the opposing commander's machine and bringing it down with concentrated cannon fire. The Com Guard unit refused to participate in Operation Scorpion and thus was not destroyed by the Clan garrison, but it was forced to leave shortly thereafter.

PIKE SUPPORT VEHICLE

Type: **Pike Support Vehicle**
 Technology Base: Inner Sphere
 Movement Type: Tracked
 Tonnage: 60
 Battle Value: 648

Equipment	Mass
Internal Structure:	6
Engine:	14
Type:	ICE
Cruising MP:	3
Flank MP:	5
Heat Sinks:	0
Control Equipment:	3
Lift Equipment:	0
Power Amplifier:	0
Turret:	2

Equipment	Mass
Armor Factor:	144
	<i>Armor</i>
	<i>Value</i>
Front	33
R/L Side	25/25
Rear	25
Turret	36

Weapons and Ammo	Location	Tonnage
3 AC/2	Turret	18
Ammo (AC) 225	Body	5
2 SRM 2	Front	2
Ammo (SRM) 50	Body	1

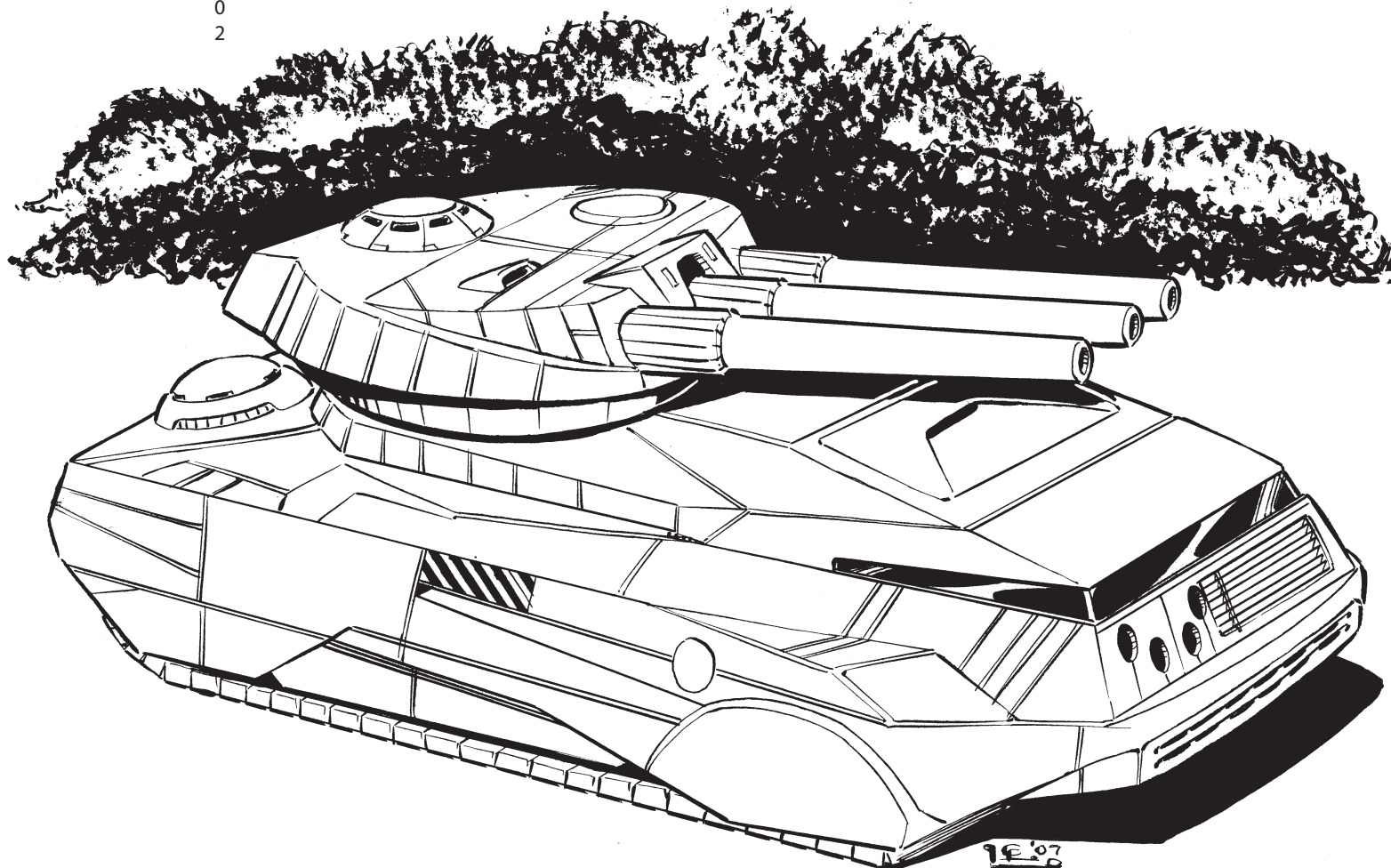

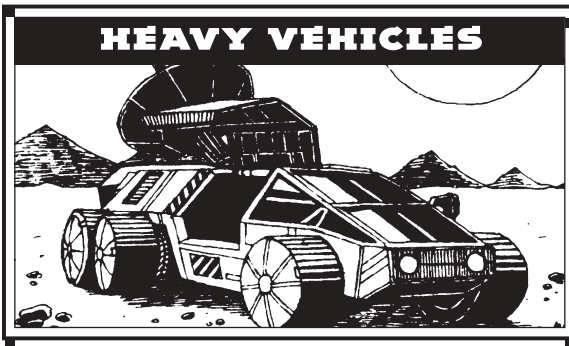

Mass: 55 tons

Movement Type: Tracked

Power Plant: Robel 110 ICE

Cruising Speed: 21 kph

Flank Speed: 32 kph

Armor: Star Slab/1

Armament:

- 1 Armstrong Industries Long Tom Rifle
- Mobile Chassis System

- 4 SperryBrowning Machine Guns

Manufacturer: Rebel Industrial Technologies, Inc.

Primary Factory: Mars

Communications System: ROMTECH 100

Targeting and Tracking System: O/P 10-40 LTR

Overview

The Mobile Long Tom (or MLT) is actually a series of tracked vehicles working together to move and position the artillery piece for firing. Manufactured originally for the SLDF, many fell into the hand of Successor States troops when the League collapsed after the Amaris Coup.

The history of the MLT is filled with stories of how its awesome firepower saved entire cities.

Capabilities

The MLT system operates as a train of six tracked transports. The tractor unit carries the artillery piece itself; towed behind it are two support (from which weapon fire is directed), and three ammunition carriages capable of carrying seventy-five rounds of ammunition. This combined vehicle travels slowly, and its endurance is limited by the ICE power plant and the requirement for frequent refueling. The sheer weight of the unit can damage regular roads and an MLT rarely travels across unpaved terrain, as there is a good chance it will get stuck.

The Long Tom is strong in long-range battles but is relatively weak at close quarters. Thus, units such as tanks, infantry, and BattleMechs often defend the unit. Though it carries four side-mounted machine guns for close defense, these are hardly enough to take on an armed 'Mech. However, the greatest threat to the mobile Long Tom is not ground forces but aerospace fighters. Therefore, units known for their anti-aircraft capability are sometimes stationed with this unit.

Deployment

It is common for Mobile Long Toms to be grouped into batteries of up to six units. The Inner Sphere militaries attach these batteries to the regimental battle group of select regiments or use them as the core for independent artillery battalions. Garrison units stationed in and near key cities usually possess one or two of these weapons.

In 2888, House Kurita launched yet another raid on the storehouses in the city of Trent on the Davion-held world of Errai. Two MLTs used Trent's massive city square as a firing platform while the local 'Mechs fought to hold back the Kurita raiders. By the time the raiders withdrew, the MLTs had destroyed more 'Mechs than all of the Davion ground forces combined.

While Houses Marik and Liao were fighting for the city of Garth on the planet Berenson, the Long Tom once again proved that it could play both a defensive and an

offensive role. The Marik attackers set themselves up in the city of Tromoth. From there, they moved up a Long Tom to bombard the city of Garth. At the same time, House Liao relocated one of their own MLTs to attack the Marik raiders. The two guns attempted to destroy each other for nearly a week. Finally, spies within Garth sabotaged and disabled the Liao gun, giving the Marik weapon free rein to bombard the rest of the city, breaking the stalemate and allowing Marik troops to capture Garth.

In 3002, House Marik raided the city of Treth on the planet Loric in the Lyran Commonwealth. By moving and firing their only MLT, the Steiner defenders fooled the Marik forces into thinking there were three MLTs in and around the city. The Free Worlds League withdrew quickly without imparting any serious damage to the Steiner forces.

Variants

A rare variant of the Mobile Long Tom is the LT-MOB-50 rail version. Although lacking the tracked version's freedom of movement (and, in fact, its use of rails can be a tactical liability), it can travel faster via rail.

Notable Crews

Captain John Cassion: John commands the Long Tom battery assigned to the New Battle Creek Defense League on the Davion world of Kestrel. He has served on a Mobile Long Tom crew since he was fifteen and has earned a reputation for being an excellent artilleryman.

Lieutenant Wendy Polanski: Wendy is a firing officer for House Marik, currently assigned to the 3000th Rifleman Corps. She earned fame during a series of raids against the world of Pollux, when she personally accounted for the destruction of over ten 'Mechs in a four-day period. Rumor has it that spies from House Davion have offered her a tempting job offer, but she is still a member of the 3000th.

LT-MOB-25 MOBILE LONG TOM ARTILLERY

Type: **LT-MOB-25 Mobile Long Tom Artillery**

Technology Base: Inner Sphere

Movement Type: Tracked

Tonnage: 55

Battle Value: N/A

Equipment		Mass
Internal Structure:		5.5
Engine:	110	7
Type:	ICE	
Cruising MP:	2	
Flank MP:	3	
Heat Sinks:	0	0
Control Equipment:		3
Lift Equipment:		0
Power Amplifier:		0
Turret:		0
Armor Factor:	64	4
	<i>Armor Value</i>	
Front	16	
R/L Side	16/16	
Rear	16	

Weapons and Ammo	Location	Tonnage
Long Tom	Front	30
2 Machine Guns	Right	1
2 Machine Guns	Left	1
Ammo (MG) 300	Body	1.5
Communications Equipment	Body	2
Trailer Hitch	Rear	0

Type: **LT-MOB-25 Mobile Long Tom Artillery Support Carriage**

Technology Base: Inner Sphere

Movement Type: Tracked

Tonnage: 5

Battle Value: N/A

Equipment		Mass
Internal Structure:		.5
Engine:		0
Type:	N/A	
Cruising MP:	N/A	
Flank MP:	N/A	
Heat Sinks:	0	0
Control Equipment:		0
Lift Equipment:		0
Power Amplifier:		0
Turret:		0
Armor Factor:	64	4
	<i>Armor Value</i>	
Front	16	
R/L Side	16/16	
Rear	16	

Weapons and Ammo	Location	Tonnage
Cargo Body	.5	
Trailer Hitch	Front	0
Trailer Hitch	Rear	0

Type: **LT-MOB-25 Long Tom Artillery Ammunition Carriage**

Technology Base: Inner Sphere

Movement Type: Tracked

Tonnage: 10

Battle Value: N/A

Equipment		Mass
Internal Structure:		1
Engine:		0
Type:	N/A	
Cruising MP:	N/A	
Flank MP:	N/A	
Heat Sinks:	0	0
Control Equipment:		0
Lift Equipment:		0
Power Amplifier:		0
Turret:		0
Armor Factor:	64	4
	<i>Armor Value</i>	
Front	16	
R/L Side	16/16	
Rear	16	
Turret	16	

Weapons and Ammo	Location	Tonnage
Ammo (Long Tom) 25	Body	5
Trailer Hitch	Front	0
Trailer Hitch	Rear	0

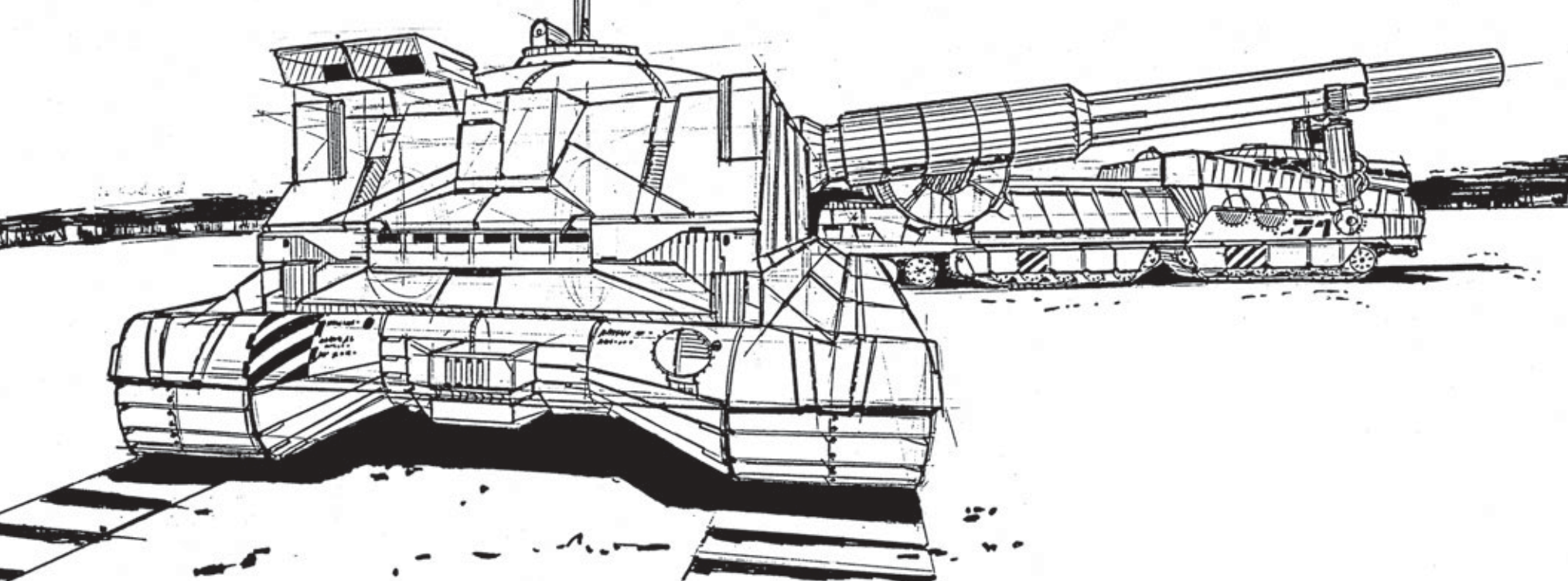

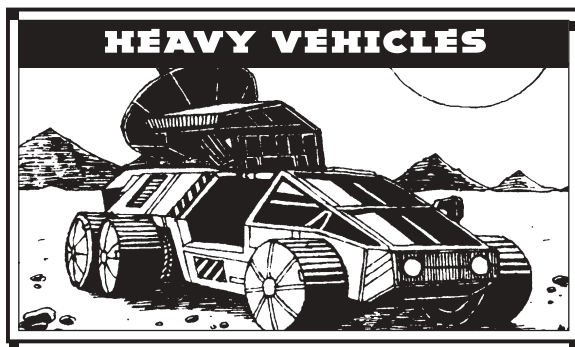

Mass: 65 tons

Movement Type: Tracked

Power Plant: Magna 260 Fusion

Cruising Speed: 43 kph

Flank Speed: 65 kph

Armor: Durallex Heavy

Armament:

Patton Tank

- 1 Defiance Killer Autocannon Type T
- 1 Coventry Five-Tube Missile System
- 1 Hotshot Flamer
- 1 A5L Small Laser

Rommel Tank

- 1 Defiance 'Mech Hunter Autocannon
- 1 Coventry Five-Tube Missile System
- 1 A5L Small Laser

Manufacturer: Defiance Industries

Primary Factory: Hesperus II

Communications System: TharHes Muse 54-58K

Targeting and Tracking System: TharHes Mars5

Overview

The Patton and Rommel are the fruits of Defiance Industries' attempt to create a new vehicle from scratch rather than rework an old Star League design. Designed to take on the burden of protecting Lyran territory, the vehicle helped to free up BattleMech forces for offensive operations against the Draconis Combine during the Fourth Succession War.

The two tanks share many components, including the chassis, fusion power plant, and electronics. It is the Magna

260 fusion engine that sets the Rommel/Patton apart from the ICE powered vehicles usually deployed by the armies of the Inner Sphere. The fusion engine also proved to be the biggest stumbling block the Lyrans had to overcome before the tank could be manufactured in the numbers required. The supply of fusion engines was limited, and what was being produced was earmarked for BattleMechs and aerospace fighters. The Lyran Commonwealth had to build new factories to produce those engines. As the Helm Memory Core had yet to be recovered, this was both an ambitious and daunting undertaking.

Capabilities

Compared to classic Age of War and Star League designs, the Rommel/Patton presents a very low silhouette. This enables it to negotiate the streets of Commonwealth cities easily while offering a small target to the enemy. Armored vehicles typically use the same weapon systems as BattleMechs. Though effective, these systems are bulky, which contributed to the height of older armored vehicle designs. However, Defiance Industries redesigned the Killer Type T autocannon on the Patton and the 'Mech Hunter on the Rommel (both formerly stock autocannons) to fit the low-profile turret.

Both tanks carry a five-tube Coventry Weapons Works long-range missile system as auxiliary armament mounted in the turret next to the autocannon. Early models allowed smoke to get into the crew compartment when the missiles were fired, but this issue has since been rectified. A bow-mounted small laser provides additional close-in firepower, and the Patton is also outfitted with a rear-mounted flamer to deal with enemy infantry.

The Patton is the most heavily armored of the two tanks, with over fourteen tons of armor. The Rommel carries a similarly respectable eleven tons of Durallex Heavy armor.

Deployment

Security surrounding the first six prototypes was especially tight. Hermann Steiner, a successful tank commander (and Archon Katrina Steiner's uncle) and project chief, chose the armor battalions of Hansen's Roughriders to test the new tanks. With their reputation for employing their armor aggressively, they were an ideal choice to find any flaws in the design.

After surviving everything the Roughriders could throw at them, the new tanks entered full production in 3027. Though originally intended to bolster planetary militias (with priority going to those stationed on heavily populated border worlds), the tank was soon being requested by frontline units too. When closer ties formed between the LCAF and AFFS, the Rommel/Patton design also appeared in Davion colors. The Civil War ended those sales.

Richard's Panzer Brigade, like Hansen's Roughriders, was granted access to the Rommel/Patton. Later, nearly a company of troops left the mercenary command when Richard "Big Daddy" Whitman died. Those troops ultimately wound up in the Taurian Concordat, where the appearance of their Lyran-built equipment on the other side of the Inner Sphere sparked wild rumors that the Concordat was building the new *Hatchetman* 'Mech as well as the Rommel tank.

In an attempt to curry favor with the newly formed Free Rasalhague Republic, Katrina Steiner provided the new state with military assistance in the form of weapons and equipment. During the Ronin War it became a common sight to see Rommel and Patton tanks fighting alongside Combine-built Manticores and Scorpions.

Variants

The newly formed Free Rasalhague Republic reverse-engineered the Rommel and Patton tanks. Unable to secure a reliable supply of fusion engines for over a decade, the Republic created a slower ICE-powered version. Known as the Axel Mk.1 and Mk. 2, these vehicles mount machine guns in place of lasers, but the LRM system is upgraded to a 10-rack. The Mk.1 carries 240 missiles and adds a second machine gun to the turret, while the Mk. 2 carries only 120 but is also armed with a vehicle flamer.

Notable Crews

Captain Dexter Finchly, Sergeant Ito Montoya, and Corporal Peter Foyle: Members of Hansen's Roughriders, Finchly and his crew were the first to take a Patton into combat on Solaris VII. Facing a raid by House Marik's Thirty-Third Marik Militia, the prototype acquitted itself admirably.

ROMMEL/PATTON TANKS

Type: **Patton Tank**
 Technology Base: Inner Sphere
 Movement Type: Tracked
 Tonnage: 65
 Battle Value: 961

Equipment		Mass
Internal Structure:		6.5
Engine:	260	20.5
Type:	Fusion	
Cruising MP:	4	
Flank MP:	6	
Heat Sinks:	10	0
Control Equipment:		3.5
Lift Equipment:		0
Power Amplifier:		0
Turret:		1.5
Armor Factor:	232	14.5

Front	51
R/L Side	46/46
Rear	38
Turret	51

Weapons and Ammo
 AC/10
 Ammo (AC) 20
 LRM 5
 Ammo (LRM) 24
 Small Laser
 Flamer

Location	Tonnage
Turret	12
Body	2
Turret	2
Body	1
Front	.5
Rear	1

Equipment	Mass
Heat Sinks:	10
Control Equipment:	3.5
Lift Equipment:	0
Power Amplifier:	0
Turret:	2
Armor Factor:	176

<i>Armor Value</i>	38
Front	38/38
R/L Side	24
Rear	38
Turret	

Type: **Rommel Tank**
 Technology Base: Inner Sphere
 Movement Type: Tracked
 Tonnage: 65
 Battle Value: 933

Equipment		Mass
Internal Structure:		6.5
Engine:	260	20.5
Type:	Fusion	
Cruising MP:	4	
Flank MP:	6	

Weapons and Ammo	Location	Tonnage
AC/20	Turret	14
Ammo (AC) 20	Body	4
LRM 5	Turret	2
Ammo (LRM) 24	Body	1
Small Laser	Front	.5

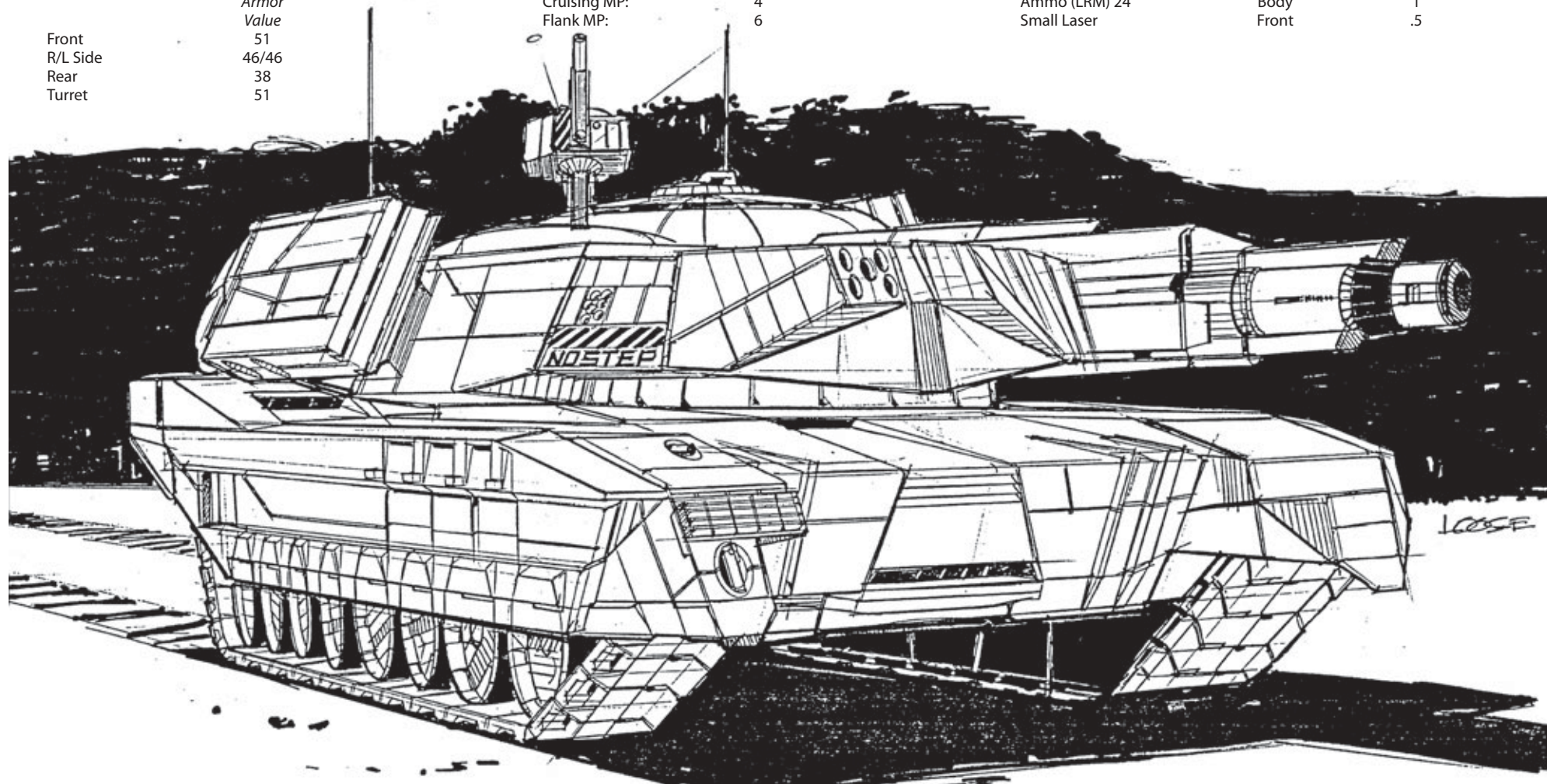

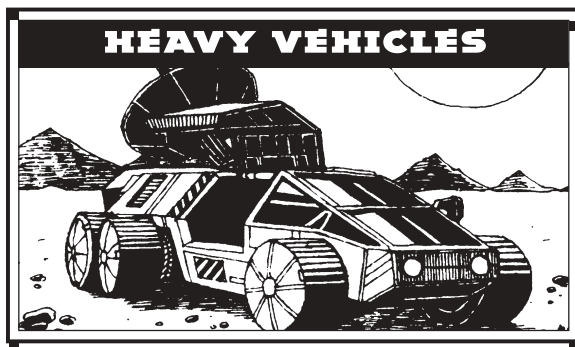

Mass: 75 tons

Movement Type: Surface Naval

Power Plant: 195 ICE (various brands)

Cruising Speed: 32 kph

Flank Speed: 54 kph

Armor: ArcShield Maxi II

Armament:

2 185mm ChemJet Gun Autocannon/20s

3 Harvester 2k SRM 2s

Manufacturer: Nav Hull

Primary Factory: None (Assembly kits produced on New Samarkand)

Communications System: Various

Targeting and Tracking System: Various

Overview

Touring the Inner Sphere, entrepreneur Robert Habeas saw on many water rich worlds a wide variety of makeshift patrol craft, often wooden barges with a few armor plates bolted on and little weaponry. Though the open oceans had formal military patrol boats, there were few designed for riverine and littoral operations, which often hosted safe havens for guerrilla. However, while relatively wealthy, Habeas lacked the resources to build and operate a dedicated production facility (not to mention ship the final product to customers). Looking at how light-industrial worlds could import pieces and assemble the final product in system, Habeas realized a way to avoid all the overhead and quickly formed Nav Hull.

Unlike other vehicles, which are shipped completely assembled and ready for use, the Monitor is shipped in an un-assembled kit. Customers, usually planetary governments, need only supply the hull, power system, and internal combustion engine, all of which are available on most planets, and certainly all easily available to the target customers.

Capabilities

The Monitor carries a devastating armament, geared for the often point-blank situations of patrolling river deltas. The two ChemJet autocannons are not only the same as those mounted on the popular Demolisher, but the entire turret is taken from the Demolisher, with Nav Hull merely navalizing the turret for the rigors of aquatic operations. Small SRM launchers dot the sides and rear to prevent it from being effectively surrounded by ambushing infantry, and the vehicle's commanders are fond of using inferno rounds to raze the shores during an ambush. The flammable inferno gel will even float and burn on the surface of a body of water for a short period of time.

The Monitor carries a light but adequate eight tons of armor, some of which is already installed on the Demolisher turret. The rest are flat plates, since Nav Hull wanted to decrease manufacturing and shipping costs as much as possible. This complicates adopting the armor to certain hull forms that customers might supply but generally provides enough armored volume for the engine, a squad of jump infantry, and sufficient displacement so that the Monitor only had a half meter draft, allowing it access to the shallowest locations.

Deployment

Nav Hull had shipped out various brands of armor, electronics suites, and weapons to the customers over the years, depending on the availability and costs of the parts. However, the Fourth Succession War led to commerce lines being disrupted, and the company found themselves unable to gather the proper materials to put together the complete kits, leading to large back orders. After the war, Nav Hull entered into a deal with the local New Samarkand Metals to provide discounted parts and materials to the small company.

Most crews find Monitor duty boring and dull, as the threat of riverine piracy and guerrillas are far more common in trid entertainment than reality. Though Monitor duty on worlds with fresh water has the potential for entertainment that is so famous in the origins of the Sea Skimmer, most planets of the Inner Sphere only have naturally contaminated waters to patrol. Not only that, but on the few occasions that they actually see action, it often is against makeshift wooden barges with recoilless rifles and small SRM tubes as armament, which are no match for a "floating Demolisher."

Variants

Though no official variants exist, Nav Hull sends along schematics to arrange the armor and electronics suite on a variety of ways, depending on the hulls available for the purchasing government or militia. Also dependent on the customer is the internal combustion engine, leaving some Monitors moving faster with a single main gun, or slower than the typical model with a trio of smaller autocannons (if available) or more armor plating.

Notable Crews

Sho-ko Hiro Bunta: A Monitor commander in the militia on Athenry, *Sho-ko* Bunta found himself caught up in the action during the hard-fought defense of its Larsen Island Chain during the War of 3039. Replacing the missiles for greater cargo capacity, the *Sho-ko* ferried hundreds of Kuritan infantrymen onto the shore on every island, using his pair of autocannons to shatter the beach emplacements at every opportunity. On several occasions he deliberately beached his vessel, nicknamed "No Regrets," in order to provide cover and a rally point for the infantrymen who found themselves scattered with little cover and under fire from the well-protected allied defenders.

MONITOR NAVAL VESSEL

Type: **Monitor Naval Vessel**
 Technology Base: Inner Sphere
 Movement Type: Surface Naval
 Tonnage: 75
 Battle Value: 789

Equipment	Mass
Internal Structure:	7.5
Engine:	195
Type:	ICE
Cruising MP:	3
Flank MP:	5
Heat Sinks:	0
Control Equipment:	4
Lift Equipment:	0
Power Amplifier:	0
Turret:	3

Equipment	Mass
Armor Factor:	128
	<i>Armor</i>
	<i>Value</i>
Front	22
R/L Side	22/22
Rear	22
Turret	40

Weapons and Ammo	Location	Tonnage
2 AC/20	Turret	28
Ammo (AC) 15	Body	3
SRM 2	Right	1
SRM 2	Left	1
SRM 2	Rear	1
Ammo (SRM) 50	Body	1
Cargo (Jump Infantry)	Body	1.5

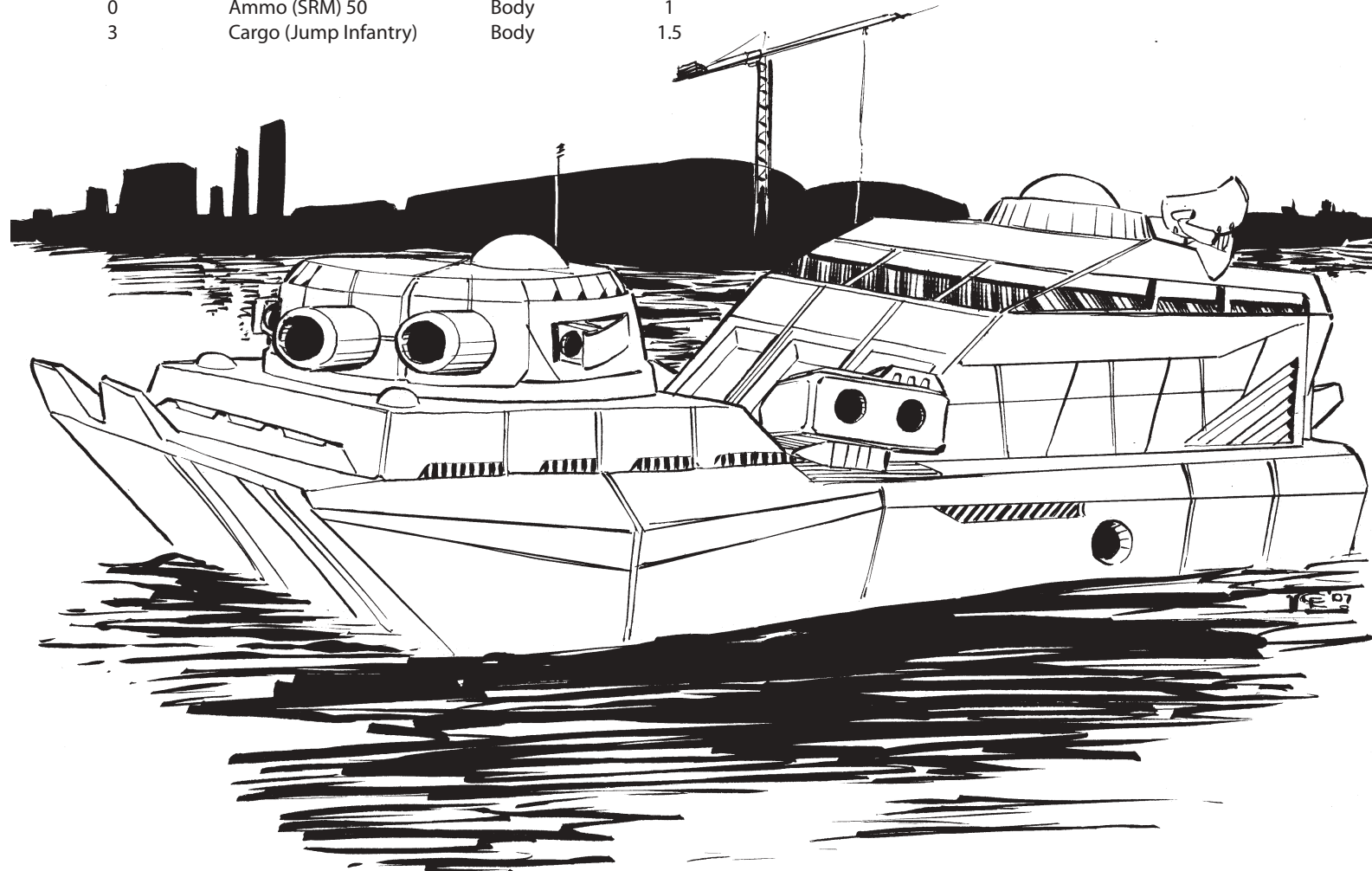

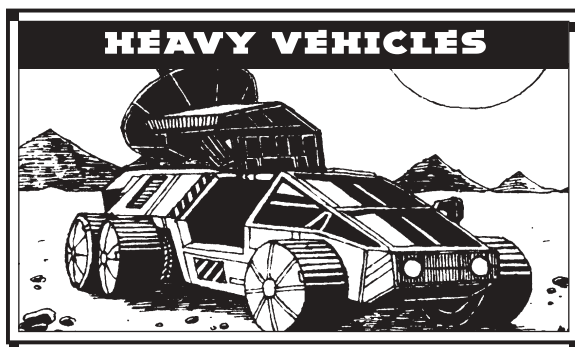

Mass: 75 tons

Movement Type: Tracked

Power Plant: VOX 225 Fusion

Cruising Speed: 32 kph

Flank Speed: 54 kph

Armor: StarSlab/4

Armament:

- 1 Armstrong Autocannon 20
- 2 Holly Short-Range Missile 6 Racks
- 1 Dannel Short-Range Missile 4 Rack
- 1 Holly Long-Range Missile 10 Rack
- 1 Ramsey Machine Gun
- 1 Firestorm Flamer System

Manufacturer: HartfordCo Industries

Primary Factory: Bryant (destroyed 2840)

Communications System: O/P 300

Targeting and Tracking System: O/P GRNDSTAT 50A

Overview

HartfordCo Industries of Bryant produced the VNL-K65N Von Luckner Heavy Tank after the Reunification War. Named after famous twentieth-century Terran raider Count Felix von Luckner, this massively armored and armed vehicle was designed as a BattleMech without legs, powered by a fusion reactor and mounting enough weaponry to endanger 'Mechs up to its own weight. The strength and resiliency of this design made the Von Luckner an ideal choice for beefing up critical defensive positions from the Terran Hegemony homeworlds to the distant reaches of the Star League's newly won Periphery territories.

Capabilities

With the job of carrying a heavy, track-based vehicles design, the Von Luckner's fusion power plant provide it with the same level of efficiency and mobility as a BattleMech of comparable weight with the unlimited operating range only fusion can provide.

The Von Luckner's primary armament consists of a single Armstrong assault autocannon, backed by twin Holly SRM 6 packs and a Dannel SRM 4 rack—all of which are turret-mounted for a maximum firing arc. A Holly LRM 10 rack, mounted high on the tank's rear, adds to the Von Luckner's ability as a fire support unit, though the unusual placement requires that the vehicle use this weapon while exposing its lighter rear armor to enemy fire. (This placement was a deliberate choice by HartfordCo's design team, who saw the primary use of the LRMs as a means of covering the retreat of other units.)

In regards to close-in weapons, the Von Luckner was designed with a Ramsey machine gun affixed to the front of the turret and backed by a fusion-based Firestorm flamer in the tank's forward section. As the Ramsey has long been known for a tendency to jam—even in the Star League's heyday—the Firestorm often fills in for its loss in battle, delivering a powerful deterrent attack against enemy infantry.

Deployment

Though the Von Luckner became a mainstay of Terran and Star League defensive forces in the time of the Star League, the loss of the HartfordCo factories on Bryant in 2840—coming as a result of the worsening global storms caused by the destruction of Bryant's Storm Inhibitors—instantly placed the vehicle on the endangered list. This was a common fate for many advanced vehicles of the Star League during the Amaris Coup and the First Succession War. With many more cannibalized for BattleMech spare parts—an ironic twist on the design standards that birthed the vehicle—only a few Von Luckners remained in service as of 3030. Once seen across the Inner Sphere, by 3039 only Houses Davion, Steiner, Marik, and Kurita still fielded Von Luckners in any appreciable quantities.

Variants

The most notable variant on the Von Luckner prior to the War of 3039 was the Federated Suns' experimental VNL-K100 model. This version carried fewer missile delivery systems than the standard and dropped both the anti-infantry weapons and some armor. In their place, they added an additional Armstrong Autocannon/20 to the turret, giving the K100 a crippling punch at close range.

The Draconis Combine, meanwhile, experimented with its own variant, dubbed the VNL-K70 model. This version downgrades the Armstrong to a SarLon MaxiCannon AC/10 and trades the Holly SRM 6 racks for a HellStar PPC, taking full advantage of the Von Luckner's fusion-based power source to mount longer-reaching firepower and reducing the vehicle's dependency on ammunition.

Notable Crews

Leutenant Raven van Hauten and Crew: During a 3017 raid on Icar by the infamous pirate Redjack Ryan, Leutenant Raven van Hauten of the Icar militia and his four-man crew led a vehicle company—including a lance of Von Luckners—against the raiders. Commanding the battle from his own Von Luckner, the "Thug Duster," van Hauten staged a devastating ambush that drove a lance of pirate 'Mechs into the path of his hidden tanks. At knife-fighting ranges, the tanks' Armstrongs and SRM racks tore apart the bandits in seconds. As the surviving raiders moved in to pursue, van Hauten's forces scattered. Using his now-retreating Von Luckners as bait for the vengeful pirates, he employed the vehicles' rear-facing LRMs to maintain a steady barrage of missile fire against the pursuers, while the rest of the company harried Ryan's forces from the flanks. The pirate forces ultimately withdrew with heavy damage, having gained nothing from their attack.

VON LUCKNER HEAVY TANK

Type: Von Luckner Heavy Tank (VNL-K65N Variant)

Technology Base: Inner Sphere

Movement Type: Tracked

Tonnage: 75

Battle Value: 1058

Equipment

Internal Structure:

Engine:

Type:

Cruising MP:

Flank MP:

Heat Sinks:

Control Equipment:

Lift Equipment:

Power Amplifier:

Turret:

225

Fusion

3

5

10

Mass

7.5

15

0

4

0

0

2.5

Equipment

Armor Factor:

Front

R/L Side

Rear

Turret

176

Armor

Value

41

30/30

30

45

Mass

11

Weapons and Ammo

AC/20

Ammo (AC) 15

2 SRM 6

Ammo (SRM) 15

SRM 4

Ammo (SRM) 25

LRM 10

Ammo (LRM) 12

Machine Gun

Ammo (MG) 100

Flamer

Location

Turret

Body

Turret

Body

Turret

Body

Rear

Body

Turret

Body

Front

Tonnage

14

3

6

1

2

1

5

1

.5

.5

1

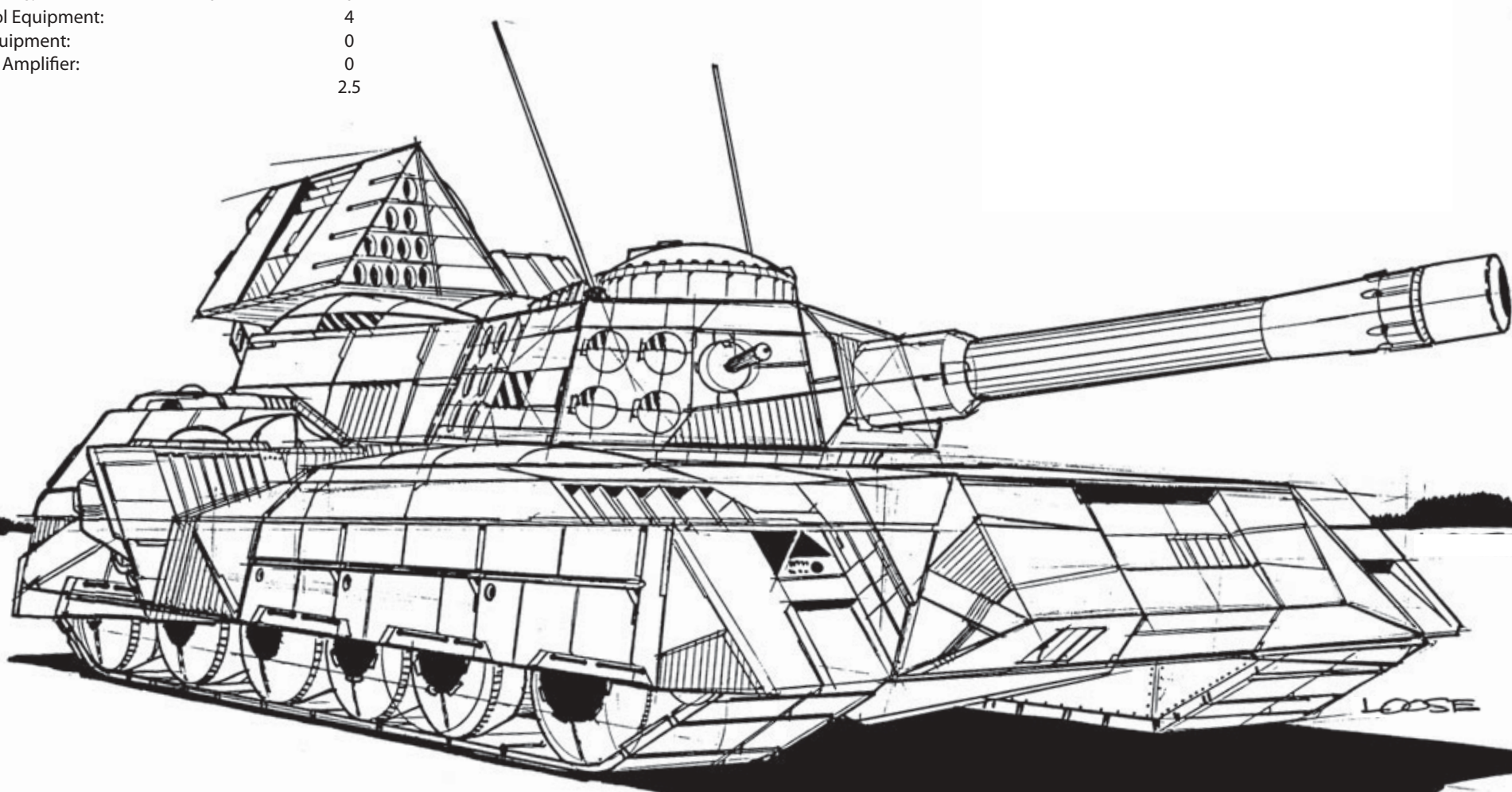

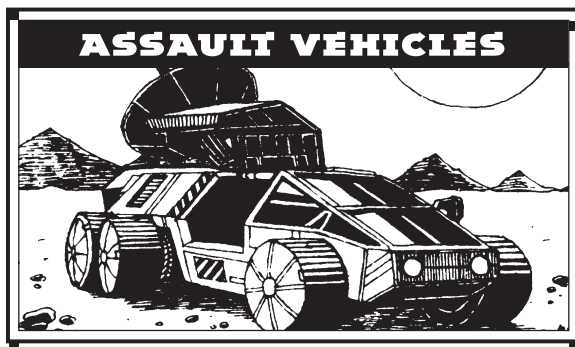

Mass: 80 tons

Movement Type: Tracked

Power Plant: GM 240 Superload ICE

Cruising Speed: 33 kph

Flank Speed: 54 kph

Armor: Durandal 160 Standard

Armament:

2 185mm ChemJet Gun Autocannon/20

Manufacturer: Aldis Industries, New Samarkand Metals

Primary Factory: Terra, Betelgeuse (Aldis),
New Samarkand (NSM)

Communications System: Omicron 5000

Targeting and Tracking System: Omicron VII

Overview

Seized by Rim Worlds Republic troops in 2767, Aldis Industries was all but destroyed during Aleksandr Kerensky's liberation of Terra. Rebuilt under the auspices of Jerome Blake's Terran reconstruction program, Aldis has operated under the protection of the neutrality ComStar crafted for Terra.

In the early days of the First Succession War, Aldis Industries engineers conceived a solution to the 'Mech technology problem. Their plan was to create a vehicle powerful enough to destroy any 'Mech, but which was attractive to worlds unable to afford 'Mech forces. Christened the Demolisher, the tank debuted in 2803 and has earned a reputation as one of the deadliest vehicles on the battlefield.

Capabilities

With two turret-mounted 185mm guns, the Demolisher is an intimidating machine. The titanic weapons use a popular propellant system that mixes two chemicals in suspension to propel a stream of huge shells at the luckless target. In older models, this produced an enormous amount of heat. As a result, crew members had to wear special coolant suits because it can get unbearably hot inside the tank during a sustained fire-fight. The current model solved the problem by channelling most of the ejection gases out through the barrels.

Designed as a defensive unit, the Demolisher is most effective in urban environments. Striking from hiding, the two massive autocannons can fell even an assault 'Mech with ease. However, the vehicle's lack of secondary weapons makes it dependent on friendly infantry to screen against enemy light armor and infantry.

Deployment

The first Demolishers were an amazing success. Many worlds lacking a standing 'Mech force bought the vehicle in quantity. Often they neglected to acquire other heavy vehicles, so the tank became known for its ability to destroy anything on the battlefield, earning its title as the "Mech Slayer." As the Succession Wars wore down the Inner Sphere's industrial base, many of these militia-operated Demolishers were drafted into frontline combat units.

Former Rim Worlds Republic troops raided the Kurita world of Kessel in 2825. Acting on information that the normal defensive force had been redeployed to the Steiner front, the attackers believed that their two BattleMech lances would be sufficient to deal with the lance of Demolishers guarding the Kessel storehouses. Overconfident, the renegades moved up one of their *Rampage* assault 'Mechs to scare the defenders into surrender. Unfortunately, this plan backfired. All four Demolishers fired at the huge 'Mech, destroying it outright. The other invaders then attacked in staggered waves, hoping to wear down the Kurita armor. But this worked no better than the previous plan, and the survivors decided it was wiser to depart empty-handed after a lucky shot decapitated their second *Rampage*.

During the Fifth Sword of Light's abortive attempt to seize the Davion world of Conroe in late 3025, the Pursuit Lance of Sorenson's Sabres was ambushed as it entered the town of Thessia. A local resistance group known as Red Thunder possessed an ancient Devastator, and they used the fusion-powered variant of the Demolisher to terrorize the elite Combine BattleMech lance. Savaged by the heavy autocannon, the Kurita troops made a hasty withdrawal.

Variants

The original Mk. I Demolisher utilized a four-tread suspension system, and this is the model that is most often thought of as a Demolisher to this day, as many remain in service across the Inner Sphere. The current production version, introduced in 2823 as the Mk. II, sports an improved suspension system and has only two tread units. Some troops remove armor to install defensive weapons to deal with infantry and small vehicles.

In an attempt to target sales at wealthy worlds, Aldis engineers installed a fusion engine in the Demolisher. Re-christened the Devastator, this vehicle carries an additional three Intek small lasers, a Zippo flamer, and a Holly SRM 6 launcher.

Notable Crews

Hildegard: "Hildegard" is the name of a Marik Militia Demolisher that has survived more than fifty engagements. In almost every battle, Hildegard's crew has been killed. Betting on the current crew's chances of survival is a popular form of wagering among the troops of House Marik.

Not surprisingly, assignment to the vehicle is seen as punishment duty. Personnel serving as crew strive to rate reassignment before Hildegard is called into battle again.

Captain Theodore Jacobs: A member of the Mobile Fire mercenary armor regiment, Jacobs has established a reputation for fearlessness and daring. Invariably found leading his assault company into battle from his Demolisher's turret, Jacobs is believed by many to be on his way to receiving a battalion command.

DEMOLISHER HEAVY TANK

Type: **Demolisher Heavy Tank**

Technology Base: Inner Sphere

Movement Type: Tracked

Tonnage: 80

Battle Value: 1069

Equipment

Internal Structure:

Engine: 240

Type: ICE

Cruising MP: 3

Flank MP: 5

Heat Sinks: 0

Mass

8

23

0

Equipment

Control Equipment:

Lift Equipment:

Power Amplifier:

Turret:

Armor Factor:

160

Armor

Value

Front

40

R/L Side

30/30

Rear

20

Turret

40

Mass

4

0

0

3

10

Weapons and Ammo

2 AC/20

Ammo (AC) 20

Location

Turret

Body

Tonnage

28

4

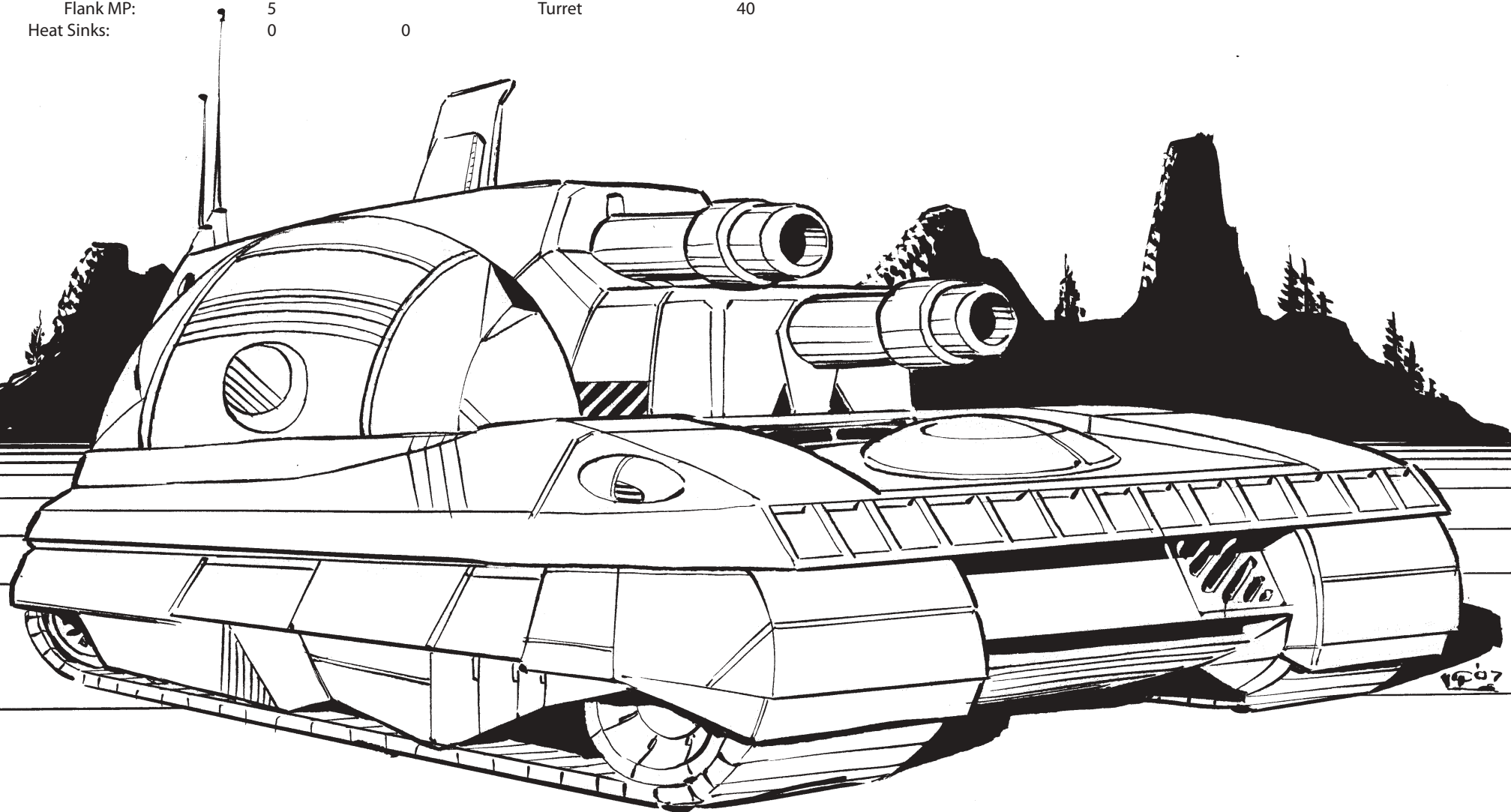

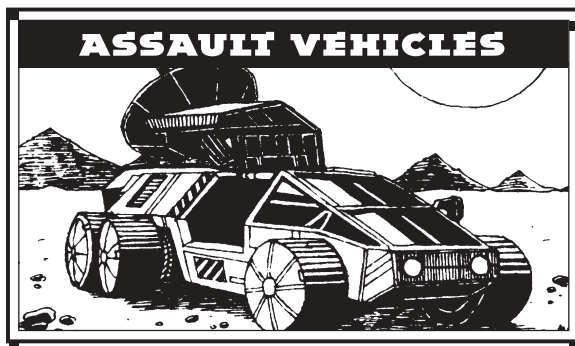

Mass: 80 tons

Movement Type: Tracked

Power Plant: GM SuperLoad 240 ICE

Cruising Speed: 32 kph

Flank Speed: 54 kph

Armor: StarSlab/7

Armament:

4 Flak Autocannon/5s

2 Auto Guns Machine Guns

Manufacturer: Kallon Industries

Primary Factory: Loyalty, Kirklin, Nanking

Communications System: JoLex Systems

Targeting and Tracking System: AntiAir Flak Systems-1

Overview

In some ways, the Partisan has been in design since the age of the airplane. As aircraft get more powerful, corresponding weapons to shoot them down keep pace. Kallon was famous for their BattleMech designs that let ground forces have a fighting chance against aircraft, but with the destruction of the Succession Wars, Kallon was unable to maintain their 'Mech output to match demand. The Partisan was the solution to this shortage.

Capabilities

The shining jewel of the Partisan is not the armor, speed, or guns but rather the targeting system. The Anti-

Air Flak Systems-1 is as capable as any other system against ground-based targets but has no equal when firing upon enemy aircraft. Capable of tracking up to two hundred targets simultaneously, it nearly instantaneously evaluates which targets are optimal for the gunner, who can fire on the computer's selection or override it and choose one of her own. The input for the system is even removable from the tank and can be used at a distance of up to twenty meters. Another unique feature of the Partisan is that the computers can be linked to one another. This network is more powerful than any individual computer and can find either the single greatest threat or the most vulnerable opponents.

Of course, the quad-mounted Flak Autocannons are fearsome at long range, while the dual machine guns provide anti-infantry defense. At short range, the Partisan is advised to withdraw, with only six tons of armor to protect it from enemy fire. With a maximum speed of 54 kph, the Partisan is more of a defensive unit than an offensive one. A common complaint is the lack of ammunition, which can be expended within minutes during intense combat. For this reason, Partisans are usually deployed near ammo resupply facilities or vehicles.

During an attack on Dobson, the Partisan was showcased against Kurita fighters. A lack of Davion aerospace assets allowed the Combine forces to land unopposed nearly ten kilometers away from Dobbiville, where FedCom forces established defensive fortifications. With their supply lines in jeopardy if they went around Dobbiville, Kurita troops were forced to assault the defenders. Nearly a wing of fighters, mainly made up of smaller *Sholagars*, attacked first, attempted to pin down and isolate the defenders. A company of Partisans was spread around the edges of the city and engaged the fighters, killing three on the initial engagement. Kuritan forces changed tactics to remove the anti-air threat and engaged the Partisans rather than the other targets. The smaller fighters used their speed to move in and out of range quickly and taxed even the Partisan's targeting abilities, but they kept the air forces occupied. When the Combine ground forces moved in, they were stopped and repulsed within a day. By the time they left Dobson, half the enemy fighters had been destroyed.

Deployment

While concentrated more in the Federated Suns and Free Worlds League where it is manufactured, the Partisan is by no means rare in any major military. The only exception to this is the Outworlds Alliance, where they generally hold air superiority and have little use for the Partisan. Sales to the Capellan Confederation and Draconis Combine fluctuate depending on the level of hostility between the realms.

Variants

Many different attempts to modify the Partisan have taken place over the several decades of its existence. However, few have improved upon the design. Lighter weight autocannons have been used, but the savings in weight is often wasted by the decreased firepower. Using missiles as the primary weapon has been tried, but the targeting computer often has problems as it tries to track every missile.

Notable Crews

Sergeant Major Steve Steiner: Steiner has commanded the same Partisan, "Xerxes," for nearly four decades as part of the Galisteo Militia. Not related to the Lyran ruling family, he brushes off any association with them and will get violent if anyone persists in talking about it. His first action was actually against a Lyran raid in 3001, where Xerxes shot down a pair of *Lucifers*. Since the Galisteo Militia doesn't have a mandatory retirement age, a long-running pool has been established to bet on when he'll retire. Rumor has it that Steiner himself has money on 3067.

Richard Hall: A talented gunner, Hall was one of the heroes of a recent raid against the city of Halstead on Cimeron. When enemy forces broke through the Davion lines, his Partisan moved forward to fill the gap, destroying five enemy tanks that had not been expecting an anti-aircraft unit to function so capably on the battlefield.

PARTISAN HEAVY TANK

Type: **Partisan Heavy Tank**

Technology Base: Inner Sphere

Movement Type: Tracked

Tonnage: 80

Battle Value: 673

Weapons and Ammo

4 AC/5

Ammo (AC) 40

2 Machine Guns

Ammo (MG) 100

Location

Turret

Body

Front

Body

Tonnage

32

2

1

.5

Equipment

Internal Structure:

Engine:

Type:

Cruising MP:

Flank MP:

Heat Sinks:

Control Equipment:

Lift Equipment:

Power Amplifier:

Turret:

Armor Factor:

Mass

8

23

ICE

3

5

0

4

0

0

3.5

6

Armor Value

Front

R/L Side

Rear

Turret

22

18/18

16

22

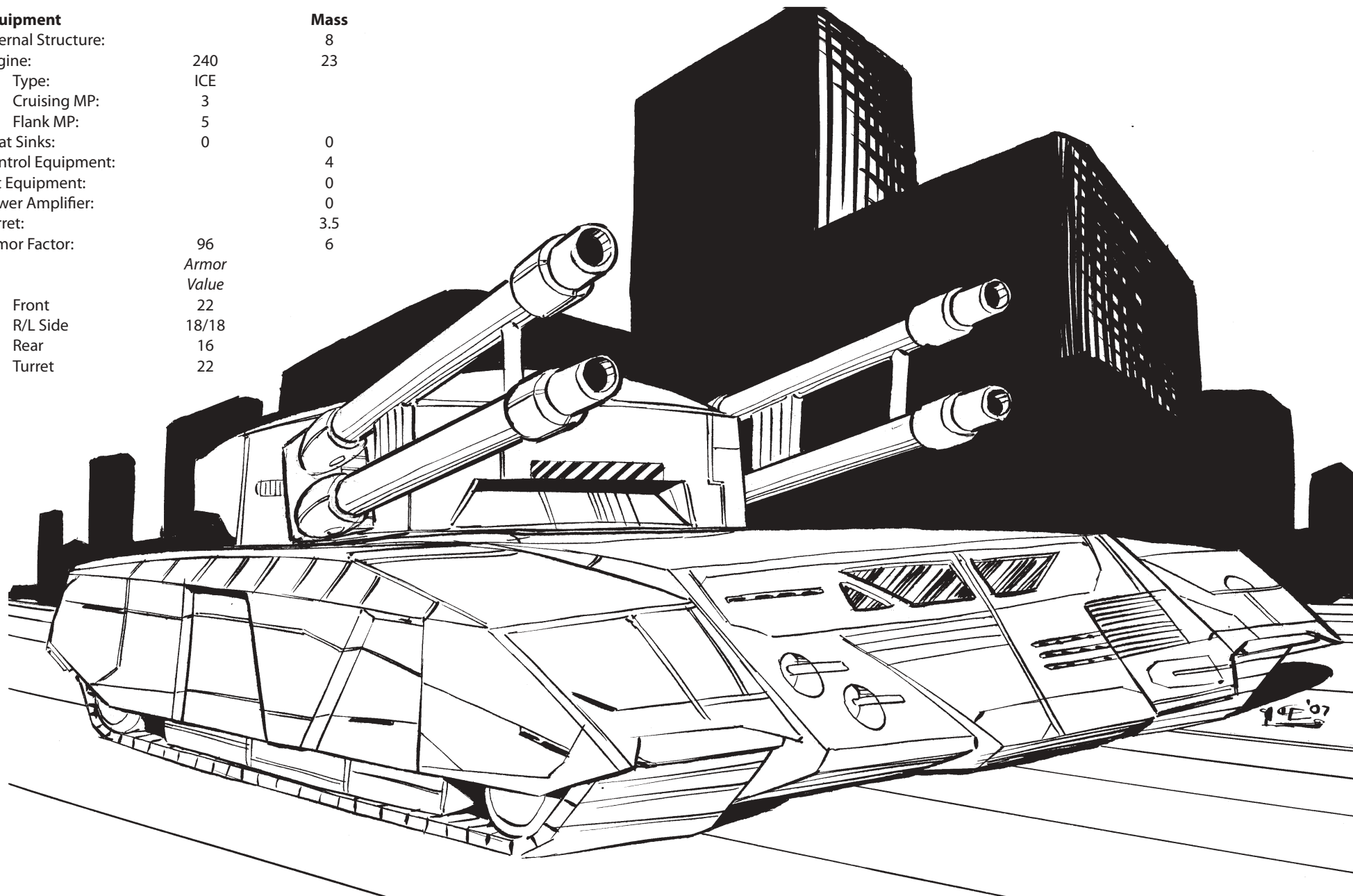

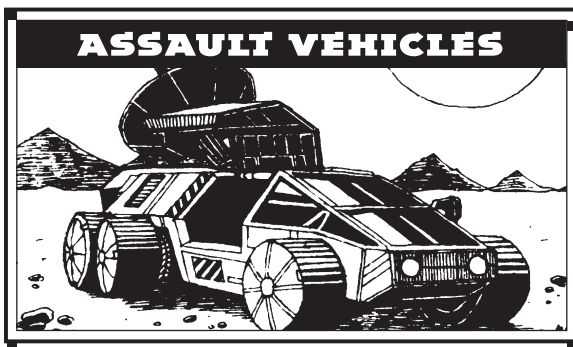

Mass: 80 tons

Movement Type: Tracked

Power Plant: GoreTex 240 Fusion

Cruising Speed: 32 kph

Flank Speed: 54 kph

Armor: ArcShield VII Mk 5

Armament:

3 HellStar PPCs

Manufacturer: Aldis Industries, New Samarkand Metals

Primary Factory: Terra, Betelgeuse (Aldis),
New Samarkand (NSM)

Communications System: Olmstead 3000

Targeting and Tracking System: Omicron IX

Overview

Aldis Industries was immensely successful with its Demolisher Heavy Tank, although the heat problems of that vehicle proved a considerable hurdle. Taking an entirely different tack, Aldis released the Schrek ten years later in 2813, which did not have the same heat issues. Created by Aldis to outperform the Demolisher, it is likely that the ancient Alacorn Heavy Tank and the AWS-8Q *Awesome* also served as an inspiration for the design. The Schrek's three particle cannons employ some of the most advanced technologies available to Aldis, including magnetic lenses at the muzzle of the cannons that adjust the course of the particle stream by a few degrees. These lenses can further be rotated along their axis, allowing the

Schrek to engage targets beyond the limits of its turret's current facing. The extremely long barrels include a larger acceleration array, allowing the HellStar to expel particles at higher energies than normal. The Schrek uses less particle mass per shot, which reduces maintenance on the particle injection system. The larger acceleration array does consume some of the advantage, but it tends to be a less sensitive component.

Capabilities

Designed for extended, long-range bombardments, Aldis optimized the vehicle's ability to be used in prepared positions by lowering its profile, if at the expense of crew comfort. Employed from this hull-down position, the Schrek can inflict substantial damage on hostile units as they approach while minimizing the damage it suffers in return. And while it has the firepower to place considerable stress on enemy formations and fortifications, its weak armor compared to other heavy tanks combined with its limited mobility prevent the Schrek PPC Carrier from functioning as a main battle tank. Forces confronted by the Schrek tend to be aware of this, targeting the vehicles to swiftly reduce the firepower of their enemy's arsenal. Schreks are therefore rarely deployed without escorts. It is no accident that the Demolisher is almost perfect for this task. The Schrek likewise compensates for the Demolisher's lack of ranged firepower, making mixed companies of the two tanks difficult to engage.

The Schrek mounts the Olmstead 3000 communications package, which does not suffer from the same power supply issues as previous Olmsteads thanks to the Schrek's power plant. The Omicron IX targeting and tracking suite, along with its distinctive sensor blister above the right tread, similarly benefits from the Schrek's GoreTex fusion power plant. Even more demanding of power than the old Omicron suite, the Mk. IX facilitates the Schrek's ability to strike its target at range.

Deployment

While not problematic in the era it was created, the Schrek's advanced weaponry and fusion engine presented

additional challenges for units that fielded the tank in the thirtieth and early thirty-first centuries. In the late Succession Wars era, most techs with competence in the fields of fusion engines and particle cannons were often assigned to BattleMech units, decreasing the number of qualified staff assigned to the Schrek. Aldis invested some funds to provide training to the maintenance personnel of prospective buyers, but the issue has become an increasingly widespread problem, reducing the Schrek's potential market. By the 3030s, it was rare to find the vehicle outside well-equipped units. For example, Schreks were not uncommon in units which have already solved this logistics problem for their Manticore Heavy Tanks. [EDITOR'S NOTE: The resurgence in technology that began in that decade eventually saved the design from extinction, though it was not until the late 3040s that sales picked up.]

Variants

Few variants of the Schrek exist, although several units have sacrificed some of the Schrek's already unimpressive armor to mount anti-infantry weaponry. This is done to compensate for the tank's significant vulnerability to infantry attacks.

Schreks are often cannibalized to replace the PPCs or fusion engines of BattleMechs. Some owners have installed ICE engines and autocannons to make use of the expensive tank, creating a potent vehicle with a similar mission profile. Without the heat sink tonnage of the original Schrek, these "autocannon carriers" also benefit from additional armor.

Notable Crews

Lt. Colonel Samuel Garibaldi: Second-in-command in the First Marik Militia, Garibaldi has used his family's funds to purchase a lance of Schreks. They are attached to his command lance, and the Colonel has publicly announced he acquired them to act as a mobile re-supply of PPCs and fusion engines for his *Awesome* that can also shoot back. Fortunately for the unit's morale, the First Marik's sizable armor corps appreciates the joke.

SCHREK PPC CARRIER

Type: **Schrek PPC Carrier**

Technology Base: Inner Sphere

Movement Type: Tracked

Tonnage: 80

Battle Value: 935

Equipment

Internal Structure:

Engine: 240

Type: Fusion

Cruising MP: 3

Flank MP: 5

Mass

8

17.5

Equipment

Heat Sinks: 30

Control Equipment:

Lift Equipment:

Power Amplifier:

Turret:

Mass

20

4

0

0

2.5

Equipment

Armor Factor:

Front

R/L Side

Rear

Turret

112

Armor

Value

24

20/20

20

28

Mass

7

Weapons and Ammo

3 PPC

Location

Turret

Tonnage

21

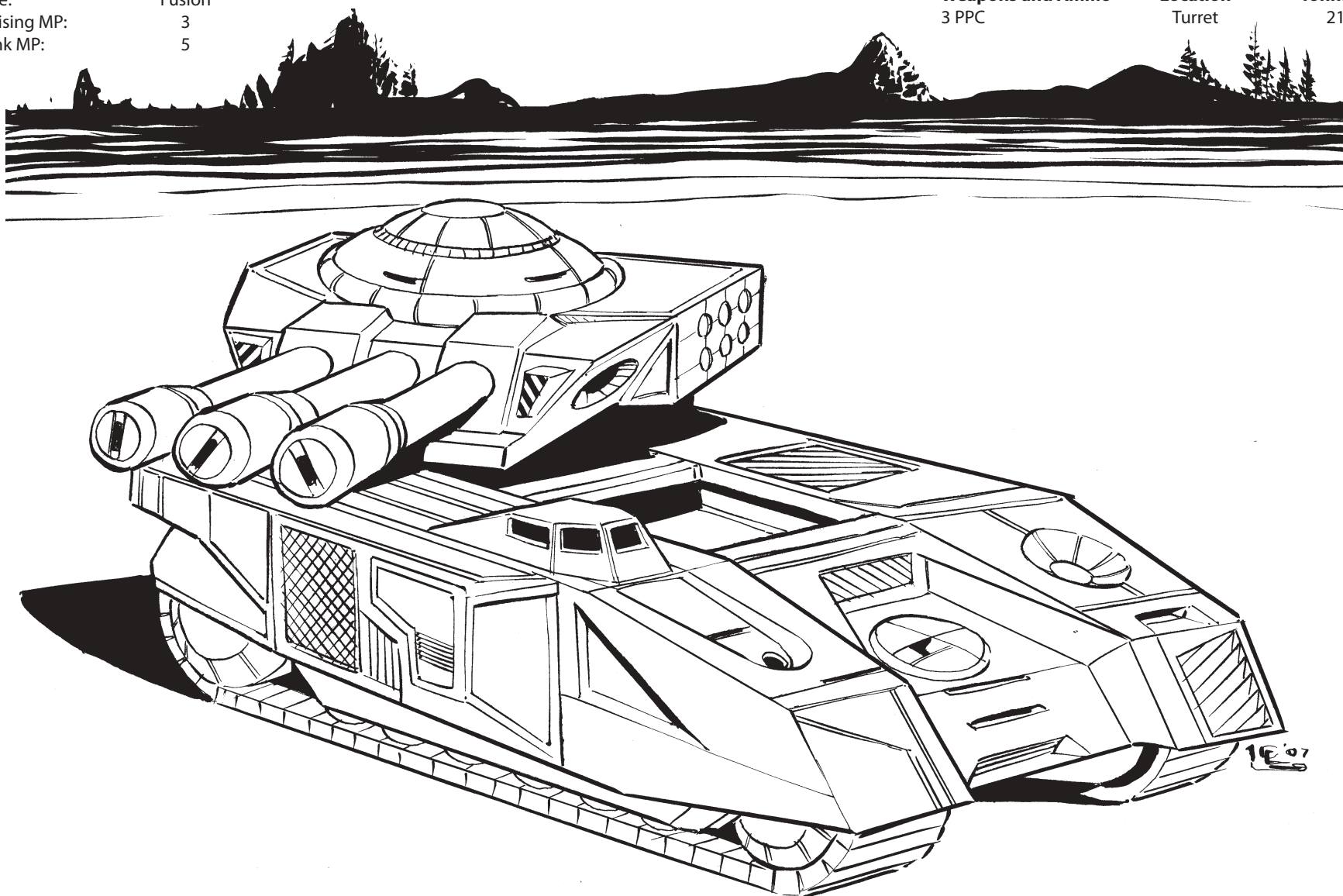

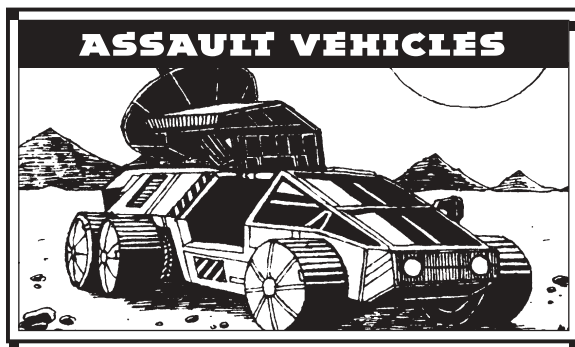

Mass: 85 tons
Movement Type: Tracked
Power Plant: InterComBust 255 ICE
Cruising Speed: 32 kph
Flank Speed: 54 kph
Armor: ProtecTech 7
Armament:
2 SturmFeur LRM 20 Launchers
2 MiniGuns Machine Guns
Manufacturer: Trelshire Heavy Industries
Primary Factory: Sudeten
Communications System: Angst 2100-b
Targeting and Tracking System: SturmFeur
Highlight with BlindFire Radar

Overview

In the early 31st Century, the Lyran Commonwealth sought a fire-support design that could survive several counterstrikes before having to withdraw. The result was the SturmFeur, which debuted in 3018. Using a low-profile design, it also was designed to support friendly forces via indirect means and exploit cover more effectively than the typical, high-profile tanks of the era. [EDITOR'S NOTE: The low profile concept was later incorporated into Defiance Industries' Rommel and Patton tanks.]

Capabilities

The SturmFeur carries a pair of massive LRM 20 racks backed by two machine guns for point blank anti-infantry

defense. To prevent fratricide in the dense missile volleys, the SturmFeur prototypes went through a large number of launcher configurations, including rotary and vertical launchers. Eventually, the launchers were split up, with one conventionally mounted on a turret and the other mounted counter-intuitively on the rear deck of the hull in a near-vertical facing. A brand new terminal guidance system was created to handle the unusual launcher arrangement. The volleys were thus spared collisions during launch, since the turret launcher fired in a traditional line-of-sight to the target while the body-mounted tubes fired forward on a high arc.

Unlike many other fire-support vehicles, the SturmFeur is armored heavily, more so than even many frontline tanks. The nineteen-and-a-half tons of armor allow the SturmFeur to withstand tremendous amount of damage, something appreciated by missile carrier crews who are used to paper-thin armor that disintegrates (as the crews will tell you) "when given a dirty look."

However, what the crews do not appreciate is the cramped crew compartment inside the tank. There is absolutely no room to move around, and while each chair can swivel to access their respective stations, the tank is so cramped that crews must seat themselves on chairs that slide outside the tank.

Deployment

The SturmFeur proved to be highly valued by conventional units in the Fourth Succession War. Its low profile proved to be the bane of many Free Worlds League and Kuritan troops, who found themselves coming under fire from these tanks who seemed to be able to hide behind even the most insignificant piece of terrain. It took several of these ambushes before these troops stopped taking seemingly deserted towns and parking complexes for granted.

It was even more popular among the units who received them while stationed on worlds bordering the Periphery. Most bandit groups contained lighter BattleMechs with little firepower or armor. When coming up against these raiders, the SturmFeurs would deploy in a staggered configuration, so when bandits would close with one tank in an attempt to get under the range of its missiles, they would

find themselves within optimal range of the rest of the defenders. Its heavy armor allowed the targeted SturmFeur to survive the attacks, much to the dismay of the raiders. Others have paired it up with Demolishers, which require covering fire as they advance into range.

However, outside the Federated Commonwealth alliance, very few units expressed interest, as they prefer the much less expensive (though fragile) LRM Carrier for support. Those that do find themselves in possession of a SturmFeur often utilize it as a command vehicle for their fire-support units, relying on its heavy armor to keep the commanders alive.

Variants

Many crews are content with the SturmFeur's original weaponry, not only due to its effectiveness, but also because the complicated guidance system is difficult to alter in the field. Only the manufacturer, Trelshire, offers a significant variant. Trelshire has produced limited numbers of a short-ranged variant that replaces the turret mounted LRM with quad SRM 4 packs, two tons of ammunition, and a third machine gun. Users with entire lances of SturmFeurs will usually have one of these variants as a bodyguard for the rest of the lance.

Notable Crews

Colonel Quinten Moore: Commander of the mercenary tank regiment Mobile Fire, Moore's long-standing history with the Lyran Commonwealth allowed him first access to the newly produced SturmFeur Heavy Tank. Moore invested heavily in the SturmFeur, which would eventually replace every LRM Carrier in Mobile Fire and become the Colonel's personal ride. More modified his tank with a pair of LRM 15 racks in the turret and mounting a fusion engine. Moore enjoyed the superior protection of the tank, which allowed him to survive several very hot combats that would have wrecked a lesser vehicle. Despite the SturmFeur's armor, Colonel Moore died in the heavy fighting on Konstance at Lazarus Bay, attempting to hold back the Twenty-Second Dieron Regulars in the War of 3039.

STURMFEUR HEAVY TANK

Type: **SturmFeur Heavy Tank**
 Technology Base: Inner Sphere
 Movement Type: Tracked
 Tonnage: 85
 Battle Value: 1,400

Equipment

Internal Structure:		8.5
Engine:	255	26
Type:	ICE	
Cruising MP:	3	
Flank MP:	5	
Heat Sinks:	0	0

Equipment

Control Equipment:		312
Lift Equipment:		
Power Amplifier:		
Turret:		
Armor Factor:		

Front	66
R/L Side	66/66
Rear	48
Turret	66

Mass

Control Equipment:	4.5
Lift Equipment:	0
Power Amplifier:	0
Turret:	1.5
Armor Factor:	19.5

Weapons and Ammo

LRM 20	
LRM 20	
Ammo (LRM) 18	
2 Machine Guns	
Ammo (MG) 200	

Location

Turret	10
Front	10
Body	3
Turret	1
Body	1

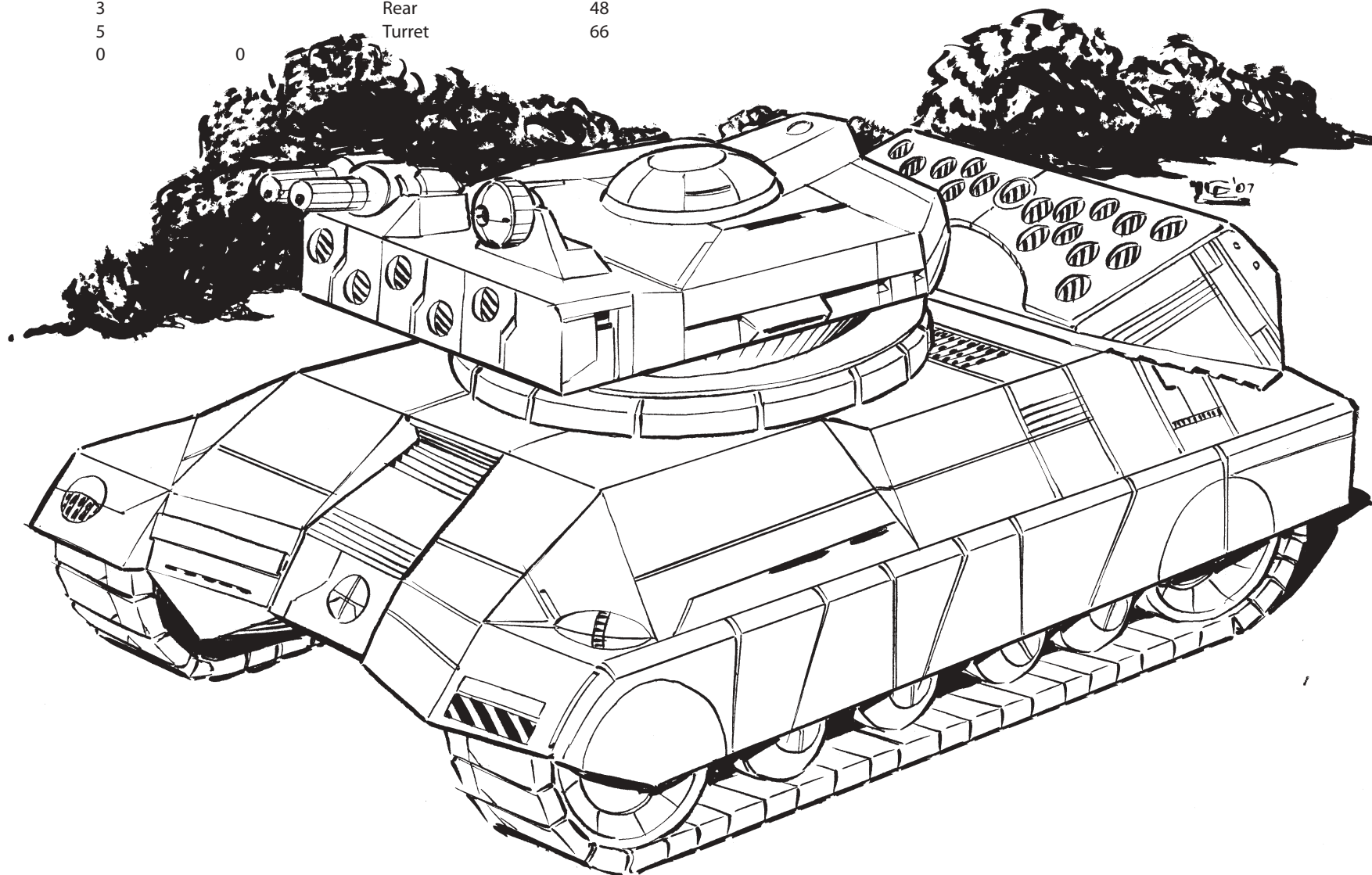

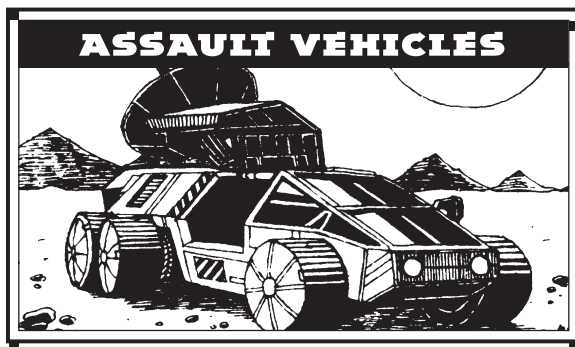

Mass: 95 tons

Movement Type: Tracked

Power Plant: HeavyLoad 285 with PowerBoost ICE

Cruising Speed: 32 kph

Flank Speed: 54 kph

Armor: SimplePlate Manufacturers Standard

Armament:

8 Martell Model 5 Medium Lasers

2 LongFire LRM 5 Racks

Manufacturer: Grumman Amalgamated, Kallon
Weapons Industries

Primary Factory: Shiro III (Grumman),
Nanking (Kallon)

Communications System: Easy Talk-2

Targeting and Tracking System: GuideRite w/Laser
Coordination Link

Overview

The old story behind the Ontos was that a designer who was a history buff designed the tank based off an ancient design, much to the chagrin of his co-workers. A second and third version were created by rival designers and put through rigorous testing at the same time. It was not superior firepower or armor or range that prompted Grumman execs to produce the Ontos, but rather the fact that after several hours of constant-fire testing, all the other vehicles had to stop to reload the exhausted ammunition bins for their main weapons at least four times, while the

Ontos only needed to reload their secondary weapons. The only thing holding the Ontos back from full production was an issue with heat build-up that could overwhelm the heat sinks and damage the power amplifier when all the lasers fired at once. Adding a system that forced the lasers to fire in a quick succession rather than at the same time eventually solved this.

Capabilities

Weighing in at an impressive 95 tons, the Ontos has a maximum speed of 54 kph. Though average for a vehicle its size, its short-ranged weapons make this speed quite a handicap. The core of the Ontos is an astounding eight turret-mounted medium lasers. More than three times the weight and space taken up by the energy weapons is devoted to their support systems such as power amplifiers and heat sinks to keep the tank from damaging its Heavy Load Internal Combustion Engine. Despite the tank's inefficiencies, it can still destroy almost three tons of armor in a single volley, and many crews admire the tank's ability to go through extended campaigns without reloading various types of ammunition.

To cover the tank's slow advance into its lasers' range, a pair of LongFire LRM 5 racks sit above the laser array. Though insignificant in comparison to many other long-range armaments on military units of similar size, the ability to fire from behind cover has proven time and time again to be invaluable, often fooling enemy units into thinking a much lighter force is present, causing them to make unadvisable advances against the Ontos.

Deployment

Though originally built in Capellan space, the Ontos was highly favored by House Marik after it captured Shiro III during the Succession Wars (and later, after the annexation of Nanking, the Federated Commonwealth), and the vehicle forms the backbone of many of the Free Worlds League's heavy tank regiments. The larger-than-average vehicle formations favored by the Marik military gave the heavy tanks plenty of support to offset their short range

Stories abound of Ontos units ambushing unsuspecting enemies from hidden emplacements and destroying their formation in moments. In one such instance, a group of Marik raiders landed on Nanking to test the defending Federated Commonwealth's strength. Both sides were equipped with a company of Ontoses. As the opponents squared off, the tanks were left in defensive positions while BattleMechs were used to draw the enemies into various traps. Neither force's BattleMechs made contact with each other, stumbling instead onto the other side's Ontoses. Both BattleMech forces were annihilated by the Ontoses, which then left their positions to seek each other out. The fight between the two tank forces left only three operational tanks to struggle off the battlefield, and the fight convinced the Marik raiders of the Federated Commonwealth's resolve to hold Nanking.

Variants

Prior to the technological renaissance, the only common variation of the Ontos came with the replacement of all the medium lasers and support equipment with a pair of LRM 20 racks and two-and-a-half tons of ammunition per launcher. A few units have been known to attempt to replace the internal combustion engine with a fusion power plant, but the modifications needed are extensive and expensive, and only a fraction have succeeded (with at times mixed results).

Notable Vehicles

Easy Ride: The crew of an Ontos stationed on Nanking found themselves and the rest of their militia defending the system from a group of Marik raiders. After ambushing and destroying the incoming BattleMech units, the tank commander and leader of the company, Captain Robert Pein, found his company of Ontoses facing a nearly identical Marik Ontos company. Though the final battle only lasted two minutes, Easy Ride was one of the two AFFC tanks able to leave the battlefield under its own power victoriously, though it had but three medium lasers and one LRM rack left functioning.

ONTOS HEAVY TANK

Type: **Ontos Heavy Tank**

Technology Base: Inner Sphere

Movement Type: Tracked

Tonnage: 95

Battle Value: 938

Equipment

Internal Structure:

Engine:

Type:

Cruising MP:

Flank MP:

Heat Sinks:

285

ICE

3

5

24

Mass

9.5

33

24

Equipment

Control Equipment:

Lift Equipment:

Power Amplifier:

Turret:

Armor Factor:

128

Armor

Value

Front

R/L Side

Rear

Turret

28

24/24

24

28

Mass

5

0

.8

1.5

8

Weapons and Ammo

8 Medium Lasers

2 LRM 5

Ammo (LRM) 24

Cargo

Location

Turret

Turret

Body

Body

Tonnage

8

4

1

.2

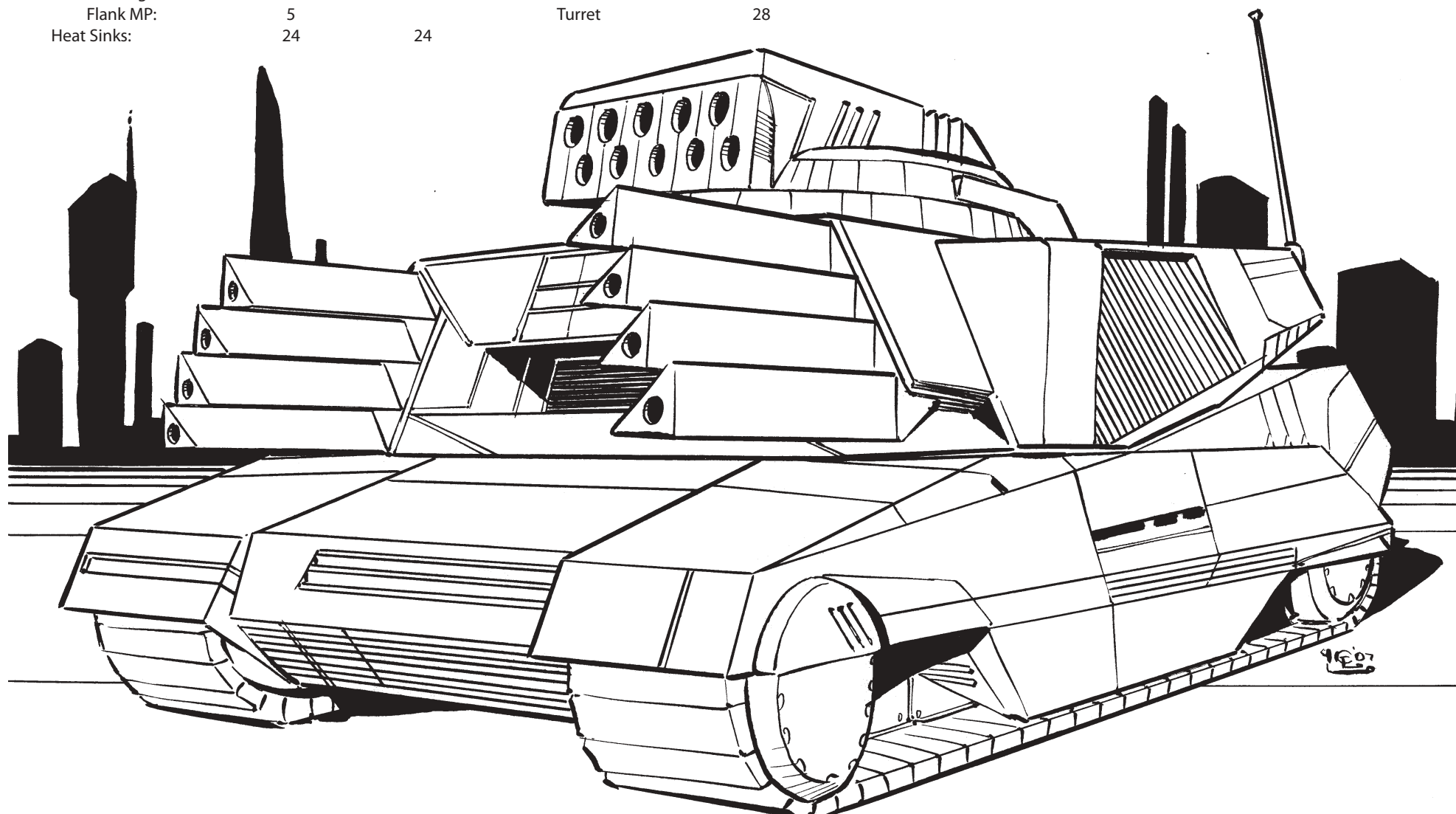

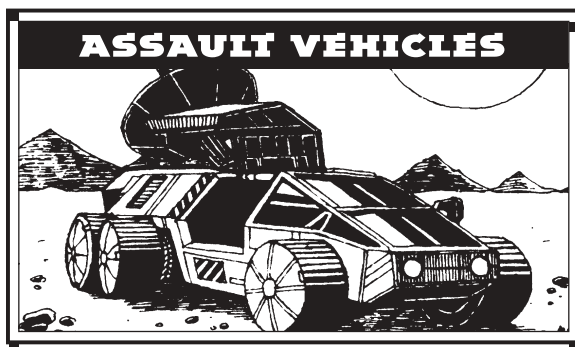

Mass: 100 tons

Movement Type: Tracked

Power Plant: GM 200 ICE

Cruising Speed: 22 kph

Flank Speed: 32 kph

Armor: ArcShield Maxi II

Armament:

2 SarLon MaxiCannon Autocannon/10s

4 LongFire Light LRM 5 Launchers

2 Harvester 20K SRM 6 Racks

2 Harvester 2K SRM 2 Racks

4 MainFire Minigun Machine Guns

Manufacturer: Aldis Industries, General Motors

Primary Factory: Terra (Aldis), Salem (GM)

Communications System: Olmstead 30

Targeting and Tracking System: Cirxese Ballista-

Check with Cirxese RockeCheck

Overview

The armies of House Davion's Federated Suns are traditionally known for their rapid deployments and swift battle plans. Enemies of the AFFS quickly learn to expect their opponents to appear anywhere, at any time. The notion of that army commissioning something as plodding and unmaneuverable as the Behemoth Heavy Tank is anathema to most Davion military planners, but Aldis Industries first premiered the vehicle to the AFFS in 2952.

At the time, the role of the conventional vehicle on the 'Mech-equipped battlefield was in doubt. It seemed a vehicle must either be fast enough to avoid the BattleMech's weaponry or carry guns of its own capable of threatening

a 'Mech's armor. The Aldis team's solution was to give the Behemoth cannons large enough to overwhelm a 'Mech while carrying enough supplementary weaponry to keep itself safe from secondary threats.

Capabilities

The centerpiece of the Behemoth's arsenal is the pair of turret-mounted SarLon MaxiCannon Autocannon/10s mounted in the turret, intended as the Behemoth's primary anti-'Mech weaponry. They are supported by a quad-mount of LongFire Light LRM 5 launchers, which provide preparatory barrage and discourage pursuit forces. Close-in protection is provided primarily by a pair of Harvester 20K SRM 6 packs, powerful weapons in use on scores of vehicles and 'Mechs. The supporting weaponry (machine guns and smaller short-range missile racks) was added almost as afterthoughts to discourage scouring attacks by infantry.

Although the original design concept called for a staggering twenty-one tons of armor, only thirteen were used to provide more weight for weaponry. Though not as thick as originally planned, the protection is more than adequate against most threats.

The only shortcoming the design team couldn't overcome was speed; with a top speed of only 32 kph, even the slowest 'Mech can easily catch up with the Behemoth if it's willing to face the firepower.

Deployment

Although the original commission came from the AFFS, Aldis has always been willing to sell to any interested buyer. To date the Behemoth has spread to nearly every Successor State military, although the largest concentrations remain in the AFFS and the Draconis Combine Mustered Soldiery. There are many stories of bravery and determination by Behemoth crews, but recent years have provided many more concrete—and documented—examples.

During the battles for Tikonov in the Fourth Succession War, several heavy armor companies of the Crucis Lancers were entering Tikograd when they came face to face with a Demolisher battalion of the Capellan Home Guard inside the city confines. The lead tanks of both sides fired, with the Behemoths taking the brunt of the damage because of the heavier caliber ChemJet guns on the Demolishers. The

Behemoths spread out, taking side streets and attempting to separate the Demolishers. A running (or perhaps, "crawling") battle ensued, with the Demolishers taking an early advantage: there were more of them, they had heavier guns, and they were faster than the Behemoths. A violent encounter between a single Behemoth and a pair of Demolishers turned the engagement around. The Behemoth crew, cornered against a demolished building, ripple-fired all of their SRMs. When the smoke cleared, both Demolishers were holed and burning. The barrage had managed to find weak points in the Demolishers' armor.

After a quick communication, the Behemoths switched from their SarLons to their Harvesters. While the Liao ChemJets still took a drastic toll on the heavy Behemoths, the Crucis companies managed to disable or drive off all of the Demolishers and secure their area of Tikograd. Standard doctrine for Davion Behemoths was changed after this engagement, giving the short-range missiles more value in anti-vehicular combat.

Variants

The sheer versatility of the basic Behemoth design makes individualizing them difficult and often redundant. Sometimes commanders in urban garrisons replace the smaller short-range missiles with flamers, but such minor variations are barely worth noting.

Notable Crews

Subcommander Ivan Karyo: Commander of a Behemoth platoon on Ares, Subcommander Karyo used to be a MechWarrior before being injured during the Andurien invasion. Relegated to conventional vehicles, Karyo chose the heaviest tank possible in order to make sure he had as many weapons as possible to keep the event from repeating. Karyo is almost constantly in his tank, which he named "Redemption." His crewmen, veterans of past combat actions, are as zealous as he is. When ordered to come off the practice field for a holiday, Subcommander Karyo challenged the duty officer—a MechWarrior—to a practice duel. Redemption destroyed the officer's *Cataphract* in two minutes of combat.

BEHEMOTH HEAVY TANK

Type: **Behemoth Heavy Tank**
 Technology Base: Inner Sphere
 Movement Type: Tracked
 Tonnage: 100
 Battle Value: 1,173

Equipment	Mass
Internal Structure:	10
Engine:	200
Type:	ICE
Cruising MP:	2
Flank MP:	3
Heat Sinks:	0

Equipment	Mass
Control Equipment:	5
Lift Equipment:	0
Power Amplifier:	0
Turret:	3
Armor Factor:	208
	<i>Armor Value</i>
Front	46
R/L Side	38/38
Rear	40
Turret	46

Weapons and Ammo	Location	Tonnage
2 AC/10	Turret	24
Ammo (AC) 20	Body	2
4 LRM 5	Front	8
Ammo (LRM) 48	Body	2
2 SRM 6	Turret	6
Ammo (SRM 6) 30	Body	2
2 SRM 2	Front	2
SRM 2	Right	1
SRM 2	Left	1
Ammo (SRM 2) 50	Body	1
2 Machine Guns	Front	1
Machine Gun	Right	.5
Machine Gun	Left	.5
Ammo (MG) 200	Body	1

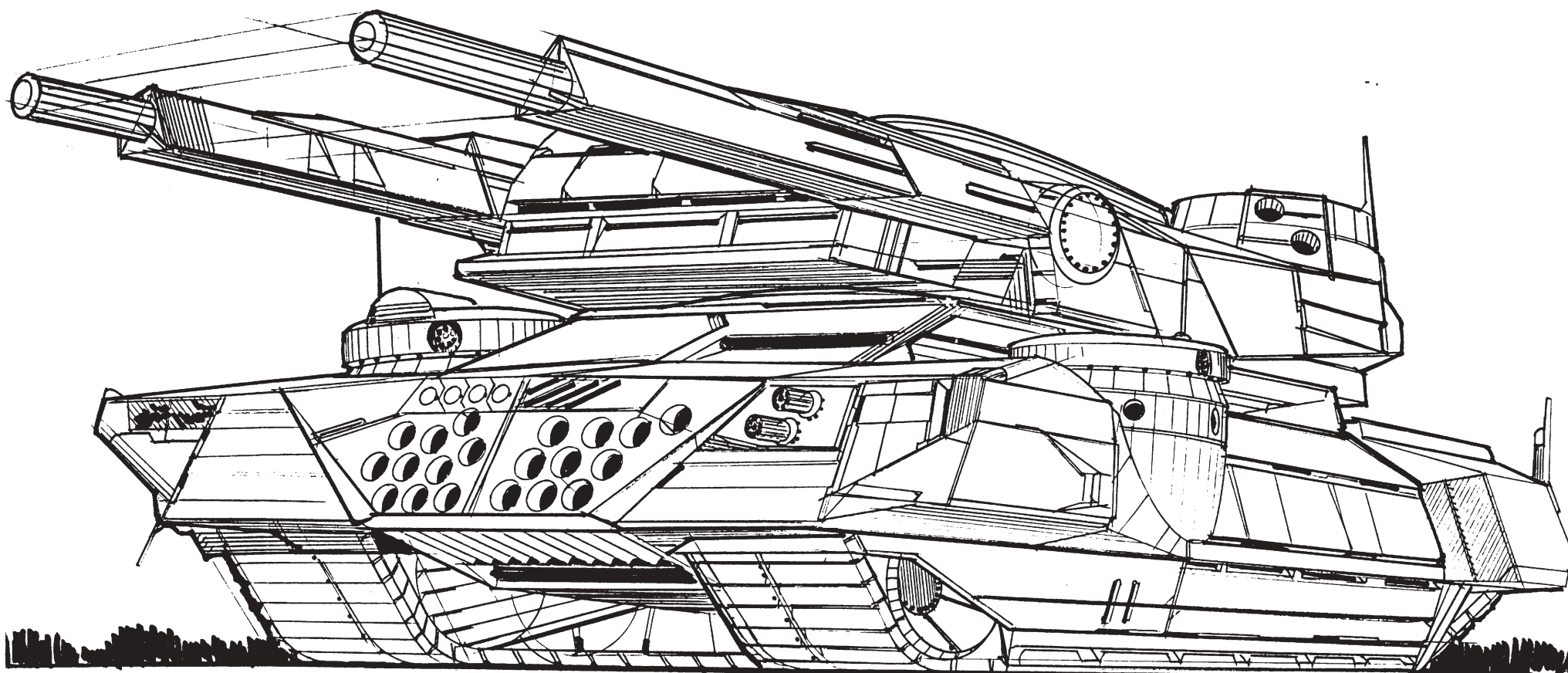

LOOSE

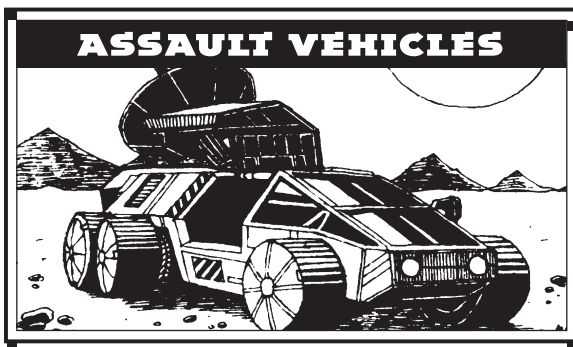

Mass: 100 tons

Movement Type: Naval

Power Plant: Doorman 270 Naval HyPerOx ICE

Cruising Speed: 32 kph

Flank Speed: 54 kph

Armor: SeaSlab/14.5

Armament:

1 Naval Sutel XII Large Laser

1 Sea Devastator 20 Rack LR Torpedo 20

2 Sea Harvester Six Rack SR Torpedos

Manufacturer: Galtor Naval Yards

Primary Factory: Exeter, Galtor

Communications System: Lynx-Shur

Targeting and Tracking System: Sonar Sync Tracker

Overview

Like many aquatic vessels, the submarine all but vanished from most military inventories. Only recently, due to a change in some House defensive tactics, have submerged military vessels made a comeback of sorts. Since attackers who disrupt or destroy enemy command centers can win a quick victory, owners of such control complexes understandably sought to guard them due to their increasing importance as targets. By the late Third Succession War, it became a cliché of war that a fixed command post could not survive the first few hours of an invasion. Yet commanders found it difficult to control a planetary battle from a mobile command post as effectively as a fixed post.

House Davion attempted to avoid this problem by placing its control facilities underwater. Using extremely low-frequency radios, buoys, and hard lines, the command posts could effectively control the land battle while remaining mostly invulnerable to aerospace fighter and DropShip attacks. With attacking forces generally limited to BattleMechs for underwater assaults—a role in which these valuable units did not perform well—it became necessary to reintroduce the submarine as a more effective defensive platform.

Capabilities

Introduced by the Galtor Naval Yards, a commercial ship builder based throughout the Draconis March, the Neptune submarine was first deployed in 2950. Though it displaces 100 tons, the six-man crew finds space cramped due to the bulk of its machinery.

The Doorman Naval 270 engine allows for a maximum speed of 54 kph, either submerged or on the surface. The engine can function in open or closed cycles. The Neptune can operate as an air-breathing diesel engine on the surface (or to a snorkel depth of twelve meters) in its open cycle, or seal the intakes and switch to hydrogen peroxide for the diesel's oxidizer at greater depths.

The Neptune has a double-hull construction, a standard for submerged vessels since the late twentieth century. The inner hull is the pressure hull, separated from outer hull's armor role for safety. The Neptune is rated for dives somewhat over a kilometer. (Early specifications leaked out via AFFS sources indicated a rather shallow dive depth of only 120 meters; AFFC officials later acknowledged the true depth of the Neptune.)

The Neptune's main armament is the Sea Devastator 20-rack torpedo system. A marinized version of the Devastator LRM, the Sea Devastator has excellent range and firepower capability. Two Sea Harvester 6-rack torpedo systems back up the Sea Devastator for overwhelming short-ranged firepower. As a secondary weapon, the Neptune mounts a Sutel XII large laser.

Deployment

By the time Hanse Davion announced the Fourth Succession War, most border planets along the Kuritan and Capellan fronts deployed at least four (and more often, twelve) Neptune-class submarines to protect their underwater command centers. With the newly formed Federated Commonwealth, Galtor Naval Yards found itself overloaded with new orders to Lyran worlds (after heavy suggestions by AFFS liaison officers) and subcontracted these out to several other Davion companies to meet the high demand. By the War of 3039, nearly every world that had a large body of water and a valuable underwater facility fielded several Neptunes in addition to any required surface vessels.

Neptunes are rarely found among House militaries other than the AFFS, LAAF, and DCMS—as GNY's newly rebuilt headquarters on Galtor were lost to the Draconis Combine during the Fourth Succession War—unless the world was formerly part of the Federated Commonwealth.

Variants

The Neptune's main failing, according to the more vocal crews, is its lack of torpedo reloads. Some Davion variants remove the underpowered Sutel XII and add another Sea Devastator system with three additional tons of ammunition. More defensive-minded crews (or those who like the close-quarters combat of a tight naval engagement) will instead swap the Sutel XII with a few more Sea Harvester tubes and additional ammo. Both of these versions may mount surface-to-surface missile systems for shore bombardment roles, if necessary.

Notable Crews

Captain Jonathan Larson and the Bowfin: The Bowfin was responsible for a successful defense of the command post on New Ivaarsen in 3021, when House Kurita's Fifth Galedon Regulars hit the world. The Bowfin defeated a lance of enemy *Dragons* during a three-hour battle in the murky water offshore. The inspired defense was led by Ensign Henry Larson, who later died during a surface retreat from a heavily defended shoreline supply base that turned out to be a decoy. Jonathan Larson was awarded the command of his father's ship when he made captain in 3033.

NEPTUNE SUBMARINE

Type: **Neptune Submarine**

Technology Base: Inner Sphere

Movement Type: Naval

Tonnage: 100

Battle Value: 963

Equipment

Internal Structure:

Engine: 270

Type: ICE

Cruising MP: 3

Flank MP: 5

Heat Sinks: 8

Control Equipment: 5

Lift Equipment: 0

Power Amplifier: .5

Diving Equipment: 10

Mass

10

29

8

5

0

.5

10

Equipment

Armor Factor:

232

Armor

Value

Front 78

R/L Side 58/58

Rear 38

Mass

14.5

Weapons and Ammo

Large Laser

LR Torpedo 20

2 SR Torpedo 6

Ammo (LR-T) 6

Ammo (SR-T) 15

Location

Front

Front

Front

Body

Body

Tonnage

5

10

6

1

1

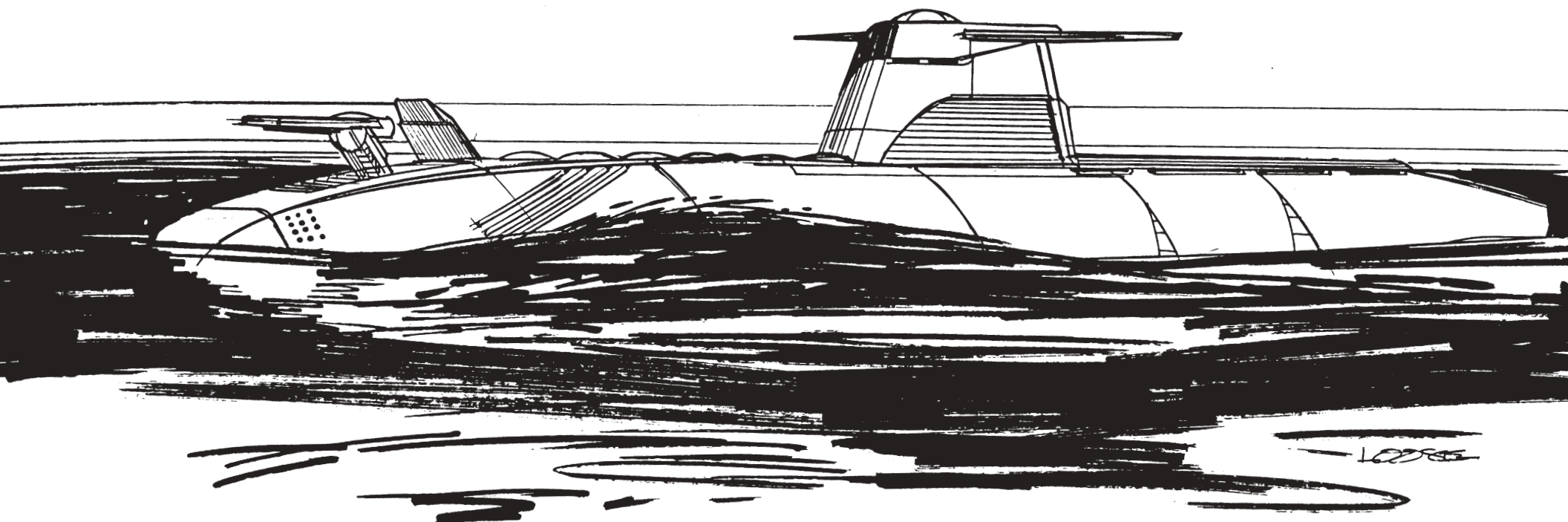

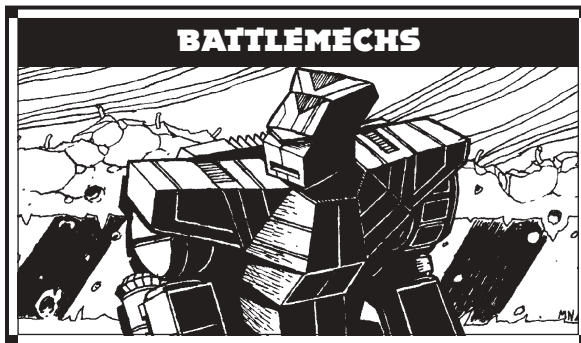

BattleMechs weigh between 20 to 100 tons, and although attempts have been made to widen this weight range, such attempts are few and unsuccessful outside of the ultra-light IndustrialMechs. Proclaimed the “Kings of the Battlefield” by every major military (and most minor ones as well), ‘Mechs are deployed in significant numbers by most forces.

‘Mechs serve in a wide variety of roles. Light ‘Mechs, weighing from 20 to 35 tons, serve as scouts and forward observers, using their superior speed to stay away from heavy fighting. Large units consisting primarily of light ‘Mechs are sometimes formed for deep penetration raids against lightly defended targets. Some light ‘Mechs are meant to support other light designs, and such support units often have significantly slower speed and are looked down upon by some as being obsolete, though they still perform admirably on the field in lieu of other options. As a flexible rear guard, protecting their force’s flank, or covering a withdrawal, a slower light ‘Mech often has enough firepower or armor to give pause to a heavier design, buying precious time for the rest of the force. Even the worst-equipped BattleMech force carries light ‘Mechs within its ranks.

Medium (40-55 tons) and heavy (60-75 tons) ‘Mechs serve as the backbone of the Inner Sphere’s military force. Mediums form the core of almost every BattleMech unit, and it is estimated that forty percent of all BattleMechs deployed are in the medium-weight class, with most of the remainder being heavy and light BattleMechs. Both medium- and heavy-weight classes have a wide variety of designs made for various roles. While other weight classes are performing supporting roles or being held back, mediums will be in the thick of the fighting slugging it out. Heavy ‘Mechs are often piloted by unit commanders or veterans in units designed to break the back of most planetary defenses in the final push of a campaign. Most commanders gauge an enemies’ approximate experience by the average weight of the opposing force; only the most skilled and experienced MechWarriors are allowed to bring their heavy BattleMechs onto the field. And when deployed, typically only another heavy- or assault-class machine can defeat them in battle.

The rarest of all, assault-class ‘Mechs (80-100 tons) are undisputedly the most fearsome sight on the battlefield. Well-designed assault ‘Mechs can often take on multiple designs of lighter weight, and one or two assault ‘Mechs are sometimes enough to turn the tide of a battle, even against heavy opposition. But having such a pivotal role has also made them targets of high importance, and the Succession Wars have taken their toll. Few units have more than ten percent of their force made up of assault ‘Mechs. This widespread destruction has left commanders fearful of deploying these valued weapons, and they will withhold them until they are absolutely necessary in a campaign.

With the deciphering of the secrets of the Helm Memory Core and the reconstruction of production lines once thought permanently lost, the replacement rate for BattleMechs has finally begun to exceed annual casualties. This has given birth to ideas of filling the ranks of regiments with heavier designs as heavy- and assault-class BattleMechs become the new workhorse designs, and lighter machines provide support. As seen with the gifting of a entire regiment of assault BattleMechs from Melissa to Hanse Davion during their wedding on the eve of the Fourth Succession War, many have begun to wonder if the medium and light ‘Mechs will become obsolete, much like conventional vehicles became with the proliferation of the BattleMech.

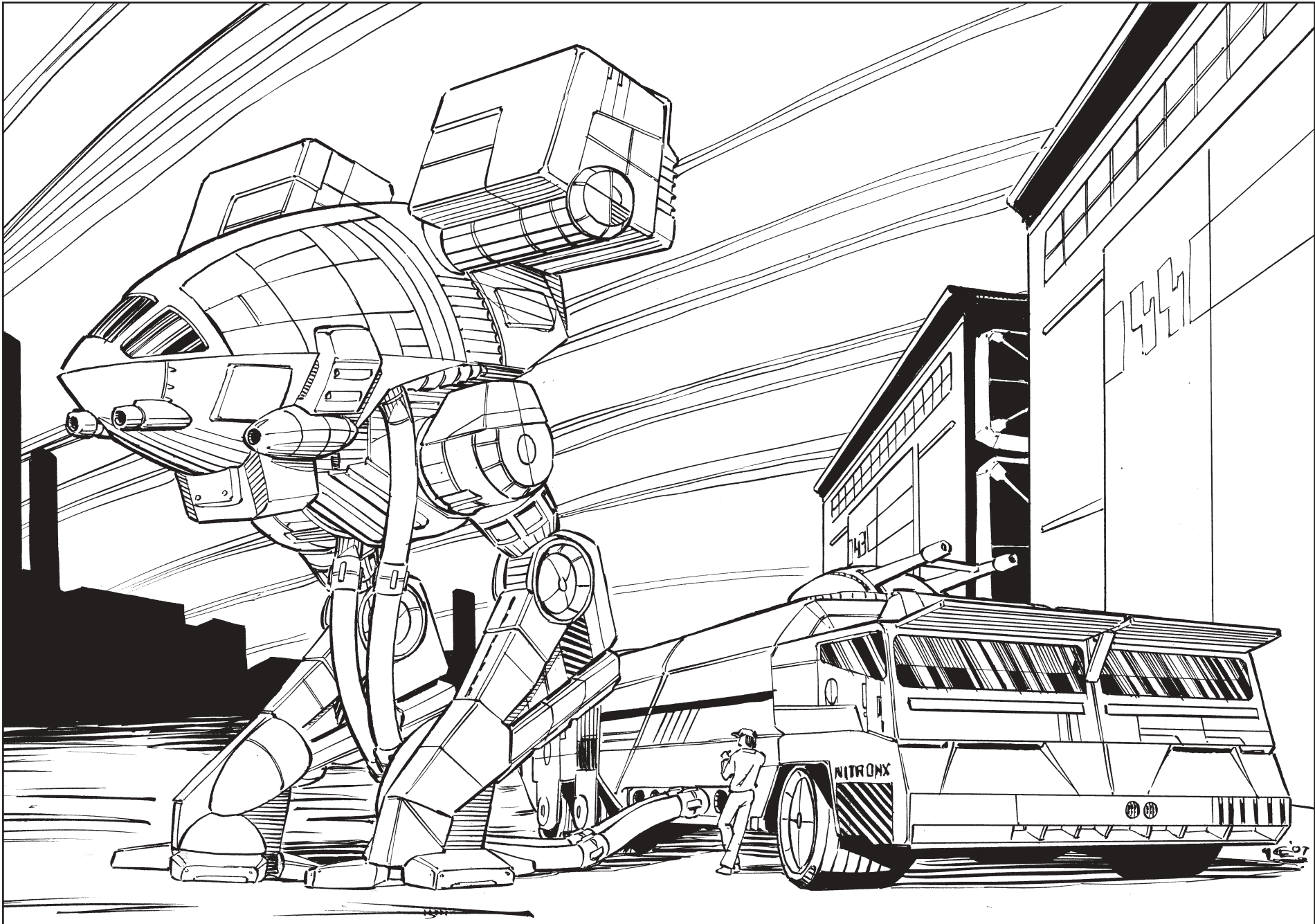

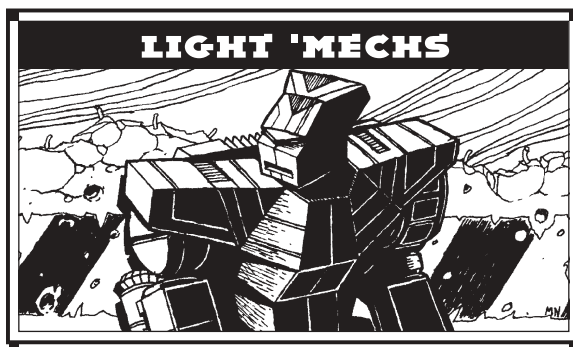

Mass: 25 tons

Chassis: Coventry Metal Works

Power Plant: GM 150

Cruising Speed: 64 kph

Maximum Speed: 97 kph

Jump Jets: None

Jump Capacity: None

Armor: Lexington Limited

Armament:

1 Shannon Six-shooter Missile Pack

1 Coventry 4-Tube Missile System

1 Defiance B3M Medium Laser

Manufacturer: Coventry Metal Works

Primary Factory: Coventry

Communications System: TharHes Crystal

Flower RG-2

Targeting and Tracking System: TharHes Star Shark

Overview

Looking to compete against the popular *Wasp* and *Stinger* designs, Coventry Metal Works (then known as Coventry Defense Conglomerate) designed and began producing the *Commando*, a slightly heavier scout that could easily handle any other reconnaissance units it may encounter or disrupt an ambush with its firepower. The Lyran Commonwealth was impressed and commissioned the *Commando* into service in 2486 for its exclusive use, employing whatever bureaucratic and diplomatic tools were needed to keep the design out of foreign powers' hands.

The current *Commando* is much different than the original. The original was built around a large laser mounted in its right arm instead of the current missile rack, but the poorly cooled laser would break down the lubricants used in the 'Mech's wrist and hand, leading to an obscenely high actuator replacement rate, sometimes after every test battle. Though the original model was officially replaced by the COM-2D, MechWarriors have periodically attempted to recreate it to personally judge the effectiveness of the initial prototype.

Capabilities

A short-range brawler, the *Commando* mounts a fearsome punch for its size that can rock the largest assault 'Mech. This firepower is achieved with pair of short-range missile packs with a total of ten tubes. Backed by an arm-mounted medium laser, this armament was frightening when it was introduced and remains a substantial threat, particularly to other light 'Mechs. However, each launcher had only a single ton of ammunition and was unable to draw from the other's bin. In an extended battle, a *Commando* would often be left with just its medium laser after a few minutes of battle.

Other minor flaws have been recognized over the *Commando*'s centuries of service. Its four tons of armor only equal that of lighter 'Mechs. Though the protection matters little against other scouts, this can be a fatal flaw against a heavier opponent. Its lack of jump jets exacerbates the vulnerability, as in heavy terrain the *Commando* may have trouble escaping a large 'Mech. MechWarriors must be mindful that the *Commando*'s firepower is not accompanied by equally heavy protection.

Deployment

The *Commando* was a popular scout among Lyran forces even though it lacked the jump capability of other successful designs. Lyrans also found them useful in pairs as they could pin down enemy scouts of heavier weight and use their devastating firepower to shred foes' armor. Against the Draconis Combine's *Panther*, however, the heavier machine's superior weapons range and jump capability proved to be a good foil against these *Commando* hunter-killer groups.

The Lyrans are methodical in their deployment of the COM-3A variant, too. Though perennially popular with those units specializing in ambushes and hunting other light units, the COM-3A's very limited ammunition left it handicapped in all but the quickest skirmishes. [EDITOR'S NOTE: After the War of 3039, some *Commandos* were retrofitted back to their original configuration in anticipation of the then-revolutionary "freezer" heat sinks preventing the associated actuator failures.]

Variants

Lyran take very few *Commando* variants seriously. The most common variant with any sort of official support is designated the 3A. The COM-3A replaces armor for a flamer and enlarges the arm-mounted short-range missile pack. Only a single ton of ammunition supplies the twin launchers.

Despite their mixed results in the past, the original 1D variant has maintained a regular, if low-profile, existence throughout the *Commando*'s history. With only three tons of armor and just the torso missile rack backing the large laser, the heat generated has made this design unpopular with many MechWarriors.

Notable MechWarriors

MechWarrior Victor Doth: A former 3E *Banshee* pilot in the Third Lyran Guards, Victor Doth was shot out of his machine during the withdrawal from Vega in the Fourth Succession War. Reassigned to a 3A *Commando* since it was the only ride available at the time, he had made his displeasure known at every opportunity for having been "turned into a Lyran infantryman with armor," despite now having more firepower and speed than he did with his *Banshee*. MechWarrior Doth made it a habit to take on assault 'Mechs in hopes of crippling them and capturing a new machine to pilot, believing that it would help when his unit would return to Vega, but he failed on every occasion. He lost his life in the War of 3039, fittingly enough, during the bitter fighting on Vega.

COM-2D COMMANDO

Type: **Commando**

Technology Base: Inner Sphere

Tonnage: 25

Battle Value: 541

Equipment

		Mass
Internal Structure:		2.5
Engine:	150	5.5
Walking MP:	6	
Running MP:	9	
Jumping MP:	0	
Heat Sinks:	10	0
Gyro:		2
Cockpit:		3
Armor Factor:	64	4

	<i>Internal Structure</i>	<i>Armor Value</i>
Head	3	6
Center Torso	8	8
Center Torso (rear)		4
R/L Torso	6	6
R/L Torso (rear)		3
R/L Arm	4	6
R/L Leg	6	8

Weapons

Weapons and Ammo	Location	Critical	Tonnage
SRM 6	CT	2	3
Ammo (SRM) 15	LT	1	1
SRM 4	RA	1	2
Ammo (SRM) 25	RT	1	1
Medium Laser	LA	1	1

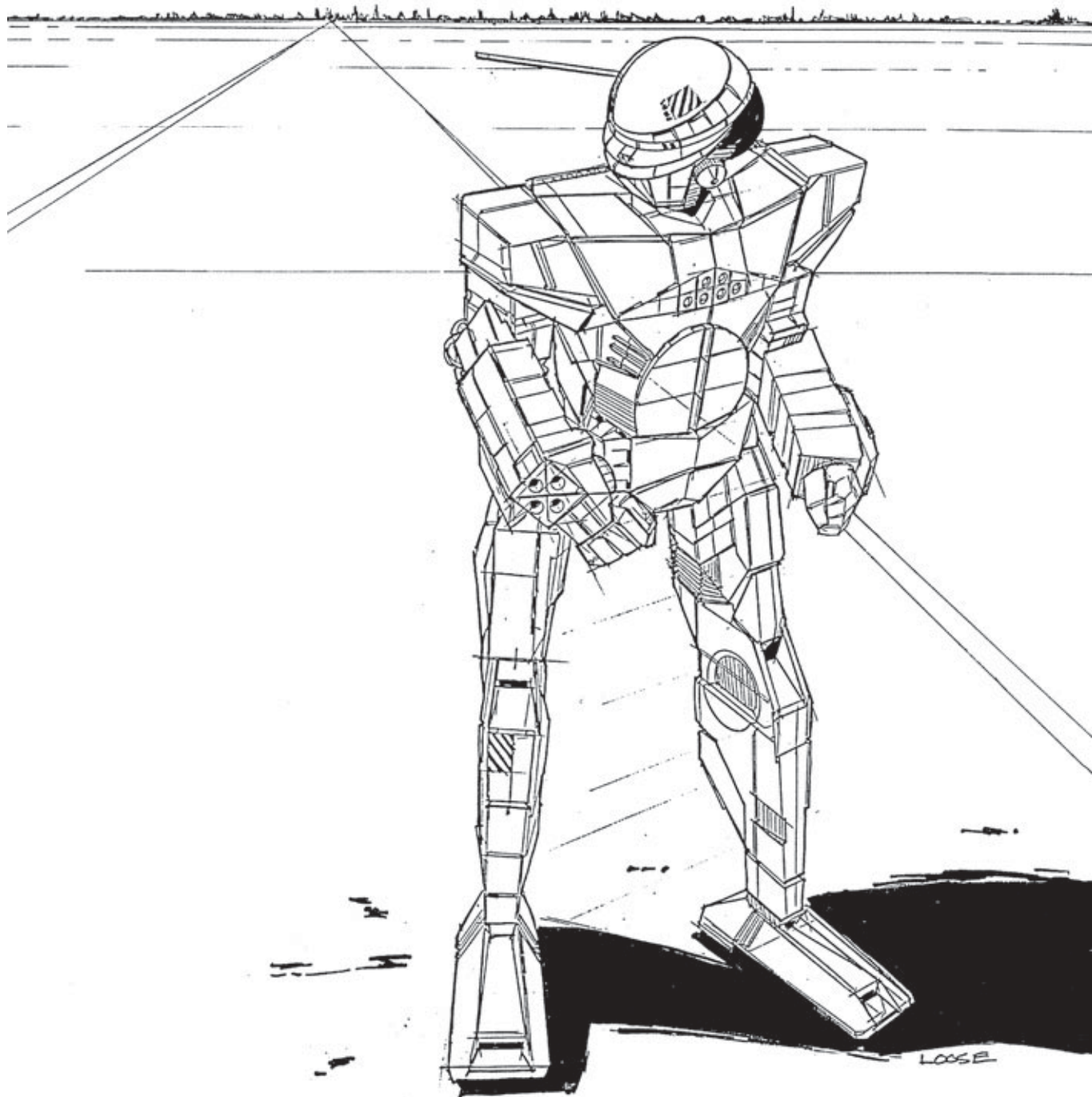

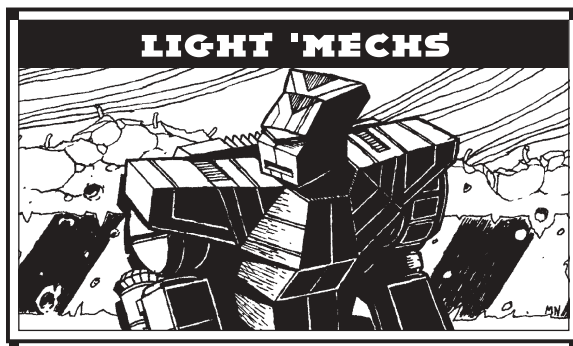

Mass: 30 tons
Chassis: Duralyte 246
Power Plant: GM 180
Cruising Speed: 64 kph
Maximum Speed: 97 kph
Jump Jets: Rawlings 95
 Jump Capacity: 180 meters
Armor: StarGuard I
Armament:
 2 Arrowlite SRM 6 Racks
Manufacturer: Stormvanger Assemblies, Light Division
 Primary Factory: Caph (destroyed 2774)
Communications System: Garret T10B
Targeting and Tracking System: Dynatec 128C

Overview

In 2751 Stormvanger Assemblies introduced the *Javelin* to the armies of the Inner Sphere as a recon 'Mech with the firepower to survive being spotted. By the opening shots of the First Succession War, the *Javelin* had not yet been fully integrated into most regiments, but centuries of warfare have proven this design well founded and reliable. Despite the destruction of its only production facility, the *Javelin* remains a popular 'Mech, especially in the regiments of House Davion. It has gained a reputation as a versatile and mobile 'Mech that can appear almost out of nowhere, giving rise to the aphorism "sneaky as a *Javelin*."

Capabilities

Although the *Javelin* functions most often as a recon 'Mech, it carries enough firepower to make it a respectable strike and ambush fighter as well. This firepower is provided by a pair of Arrowlite SRM 6 launchers embedded in the *Javelin's* chest. Each launcher is provided with a ton of ammunition, allowing the *Javelin* to enter combat without undue concern for running out of ammunition too quickly.

Rawlings 95 jump jets give the *Javelin* the mobility it needs to function on the modern battlefield in any of the roles it fills. A respectable top speed of ninety-seven kilometers per hour lets the 30-ton 'Mech keep pace with most early 31st Century scout 'Mechs, and the GM 180 fusion engine is one of the most reliable fusion plants in existence.

The only complaints MechWarriors give about the *Javelin* are its mediocre armor protection and a front-heavy center of gravity. The mass of the Arrowlites placed so far forward in the torso has a tendency to pull the *Javelin* into a forward lean, and it takes a properly dialed-in gyro to keep the 'Mech on its feet when it is running full-out. Experienced *Javelin* pilots learn to adjust for this, but newly assigned MechWarriors often spend the first few months falling over before learning exactly how far they can push their machine.

Deployment

With its long history, the *Javelin* has spread to every Successor State, but only the AFFS has embraced it and tried to employ every chassis it can. The *Javelin* appears in almost every Federated Suns 'Mech regiment, with several formations employing dozens of them. An engagement on Marduk during the War of 3039 illustrated one of the innovative uses Davion commanders have worked out for this sneaky 'Mech.

During the coursing of the Eighth Galedon Regulars outside Stanton by elements of the Tenth Deneb Light Cavalry, a small unit of heavy DCMS armor was cut off from the main body of the Combine forces. It was discovered by a recon lance from the Tenth Deneb, a lance of three

Javelins and a *Valkyrie*. The recon lance, seeing that the armor company was alone, attacked despite being outnumbered and outgunned. The lance commander knew his 'Mechs had an edge in mobility and striking power, and with Duke James Sandoval on-world, he wanted to make his name known.

With the *Valkyrie* situated on a distant ridge where its long-range missiles could rain down on the slow-moving tanks, the *Javelins* bounded forward on their jump jets, pushing every drop of performance and maneuverability out of their 'Mechs to keep from being struck down by the Kuritan armor. Once they reached a range of 200 meters, they stayed on the ground and charged right through the Combine formation, each *Javelin* unloading a full barrage of SRMs at the Combine Demolishers.

Three Demolishers were immobilized in the first assault. No *Javelins* were damaged.

For three minutes the *Javelins* repeated the tactic, each time from a different direction, while the *Valkyrie* poured the occasional LRM volley down on the tanks. By the time the remaining tanks had fled, the Combine had abandoned six Demolishers and two Behemoths, all with jammed turrets or shattered tracks. Only one of the *Javelins* had been destroyed, the victim of a lucky autocannon barrage.

Variants

Only one variation is widely used, the JVN-10F *Fire Javelin*, which replaces the Arrowlites with four medium lasers and additional armor. While popular for its endurance, many pilots run afoul of heat problems when trying to use the jump jets in synch with the lasers.

Notable MechWarriors

Captain David Albion: Then-Leftenant Albion was the lance commander on Marduk who challenged the Kuritan armor company. After the battle he was promoted and transferred to Duke Sandoval's planning staff, where he is responsible for researching more tactics that might enable light 'Mechs to stand up to heavy tanks with a chance of survival.

JVN-10N JAVELIN

Type: **Javelin**

Technology Base: Inner Sphere

Tonnage: 30

Battle Value: 594

Equipment

Internal Structure:

Engine: 180

Walking MP: 6

Running MP: 9

Jumping MP: 6

Heat Sinks: 10

Gyro:

Cockpit:

Armor Factor: 64

Mass

3

7

6

9

6

0

2

3

4

	Internal Structure	Armor Value
Head	3	6
Center Torso	10	8
Center Torso (rear)		2
R/L Torso	7	8
R/L Torso (rear)		2
R/L Arm	5	6
R/L Leg	7	8

Weapons

and Ammo

	Location	Critical	Tonnage
SRM 6	RT	2	3
Ammo (SRM) 15	RT	1	1
SRM 6	LT	2	3
Ammo (SRM) 15	LT	1	1
Jump Jets	CT	2	1
Jump Jets	RL	2	1
Jump Jets	LL	2	1

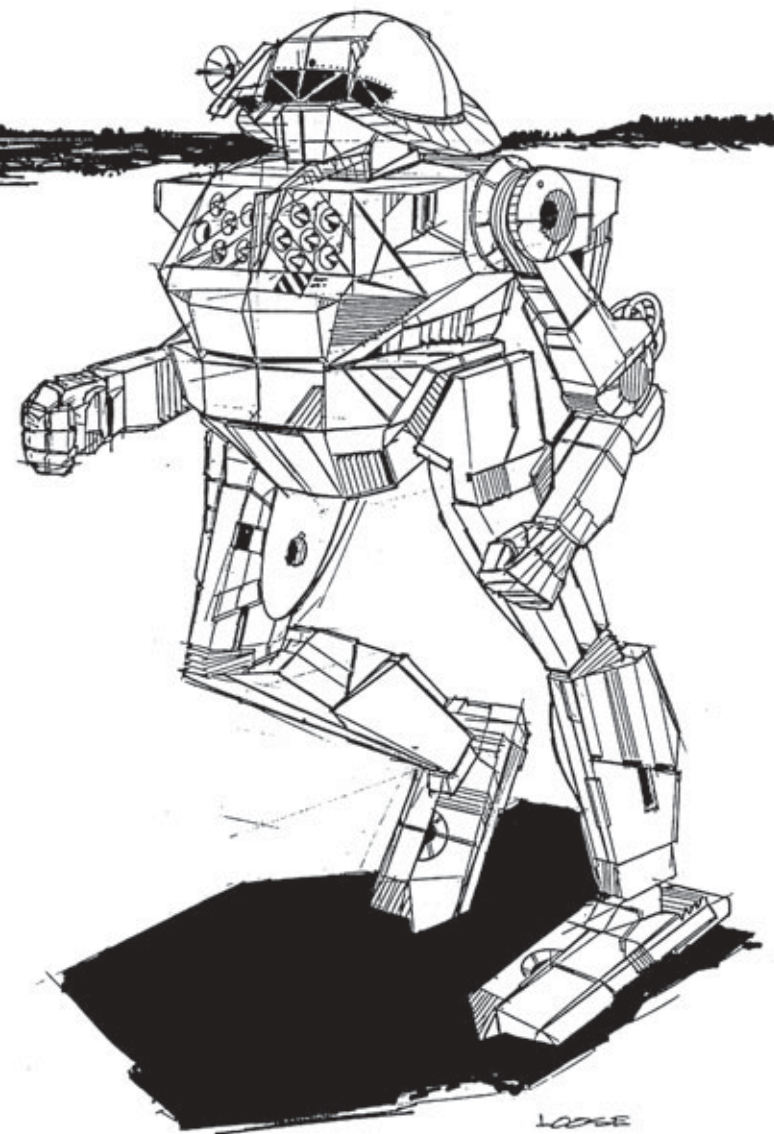

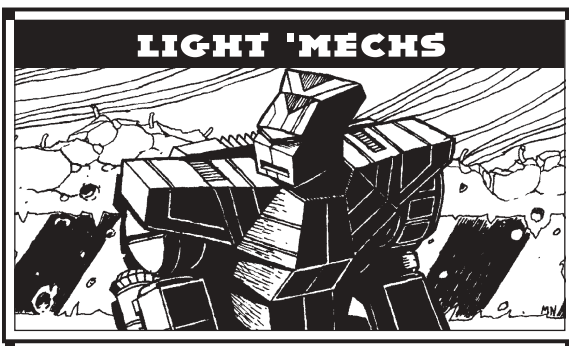

Mass: 30 tons

Chassis: Newhart 1200

Power Plant: Pitban 240

Cruising Speed: 86 kph

Maximum Speed: 129 kph

Jump Jets: Pitban LFT-10

Jump Capacity: 240 meters

Armor: Durallex Light

Armament:

2 Aberdovey Mk III Medium Lasers

Manufacturer: Nimakachi Fusion Products Ltd.

Primary Factory: Tematagi, Tematagi Minor
(Lapida II)

Communications System: O/P 500A

Targeting and Tracking System: O/P TA1240

Overview

Over 400 years old, the *Spider* was commissioned by the Star League in 2650 for use with Special Operations units. Newhart Interstellar had already designed the *Spider*, and the Star League quickly awarded them the contract. While it was not built in great quantities, the rapid manufacturing process made the *Spider* a popular unit for well-equipped scouting forces until Newhart's factories on New Earth were destroyed by Amaris' forces in 2776. With no new *Spiders* and few spare parts, their numbers dwindled, and offensive operations staged just to steal parts for the *Spider* became commonplace.

The Free Worlds League managed to secure the *Spider*'s technical schematics from the ruins of the Terran Hegemony and tasked Nimakachi Fusion Products with building the design in exchange for Nimakachi's exclusive control of *Spider* technical data. Nimakachi would later expand its Lapida II facility in the Draconis Combine to produce the design as well.

Capabilities

As fast or faster than any BattleMech of the Third Succession War, the *Spider*'s best asset is speed both on the ground and through the air, allowing the *Spider* to have far better mobility than a *Cicada* or *Locust* anywhere except a flat plain or barren desert. Designed with top-of-the-line mobility, the jump jets can even pivot in midair while the computer keeps the 'Mech on track for the original landing point. This "twitchiness" in the air, as enemy pilots refer to it, often makes the *Spider* a very hard target to acquire. In addition, the dual-laser configuration seated next to the fusion reactor needs minimum maintenance and can operate away from support longer than its pilot can. Three-and-a-half tons of Durallex armor offers decent protection against smaller weaponry, but pilots feel speed is a far better defense against enemy firepower.

One of the overlooked reasons the *Spider* is such a good recon unit is the O/P sensor and communication package. As one large system, it is fully integrated, allowing sensor readings to be transmitted alongside voice communication. Even an entertainment unit is included to allow pilots to relax a bit when forced to wait in their unit. This tremendous computer system does have a drawback, as between it and the head armor configuration, the cockpit does not have an ejection system, requiring a slower exit in case of emergency. Most pilots grudgingly accept this fact, though the few pilots of *Spiders* with ammo-dependent weapons are often found practicing escaping from their 'Mech during down time.

Deployment

A smattering of *Spiders* can be found in all the Great Houses as well as larger mercenary units. The Free World League and Draconis Combine sport the greatest numbers of them. Prior to the Fourth Succession War, Wolf's Dragoons had a large number of the Star League design, but they have since relied mainly on Federated Commonwealth manufacturers to rebuild.

Variants

Only two official variants of the *Spider* are known, while many more have been personally modified by their owner. The first of these, which is used primarily by the Federated Suns, is the SDR-5D. The 5D removes a medium laser to add an Arkum flamer to the right arm. The SDR-5K (the Draconis Combine variant) removes two jump jets and a medium laser to install a machine gun in each arm, with a full ton of ammunition seated precariously close to the fusion reactor. Both of these versions are used mainly in militia units or as part of anti-infantry actions since most MechWarriors see it as a waste of a high-performance machine.

Notable MechWarriors

Lieutenant Gwndolyn Snedcor: Recently promoted to command a strike lance in the 151st Dark Horse regiment of the Eridani Light Horse, Gwndolyn has shown a talent for both reconnaissance and raiding but is still new to issuing commands. Suffering from severe arachnophobia, she finds it ironic that she was not only assigned to a *Spider* and has talent using it, but she has also been at the forefront of the unit's run-ins with Natasha Kerensky.

Captain Rhonda Stillston: In charge of a recon company in the Addicks Draconis March Militia, Captain Stillston has been a force to be reckoned with on the Combine border for over two decades. Easily recognizable in her bright red *Spider* with gold highlights, she won't hesitate to engage units twice her 'Mech's mass, using her superior mobility to hit and run. Being on the short list for a promotion to major has curtailed her ferocity to some extent, but her company helps keep her on top of the enemy at all times.

SDR-5V SPIDER

Type: **Spider**

Technology Base: Inner Sphere

Tonnage: 30

Battle Value: 622

Equipment

Internal Structure:

Engine: 240

Walking MP: 8

Running MP: 12

Jumping MP: 8

Heat Sinks: 10

Gyro: 3

Cockpit: 3

Armor Factor: 56

Mass

3

11.5

0

3

3

3.5

	Internal Structure	Armor Value
--	--------------------	-------------

Head	3	6
------	---	---

Center Torso	10	8
--------------	----	---

Center Torso (rear)		4
---------------------	--	---

R/L Torso	7	6
-----------	---	---

R/L Torso (rear)		2
------------------	--	---

R/L Arm	5	5
---------	---	---

R/L Leg	7	6
---------	---	---

Weapons

and Ammo

	Location	Critical	Tonnage
--	----------	----------	---------

2 Medium Lasers	CT	2	2
-----------------	----	---	---

Jump Jets	RT	4	2
-----------	----	---	---

Jump Jets	LT	4	2
-----------	----	---	---

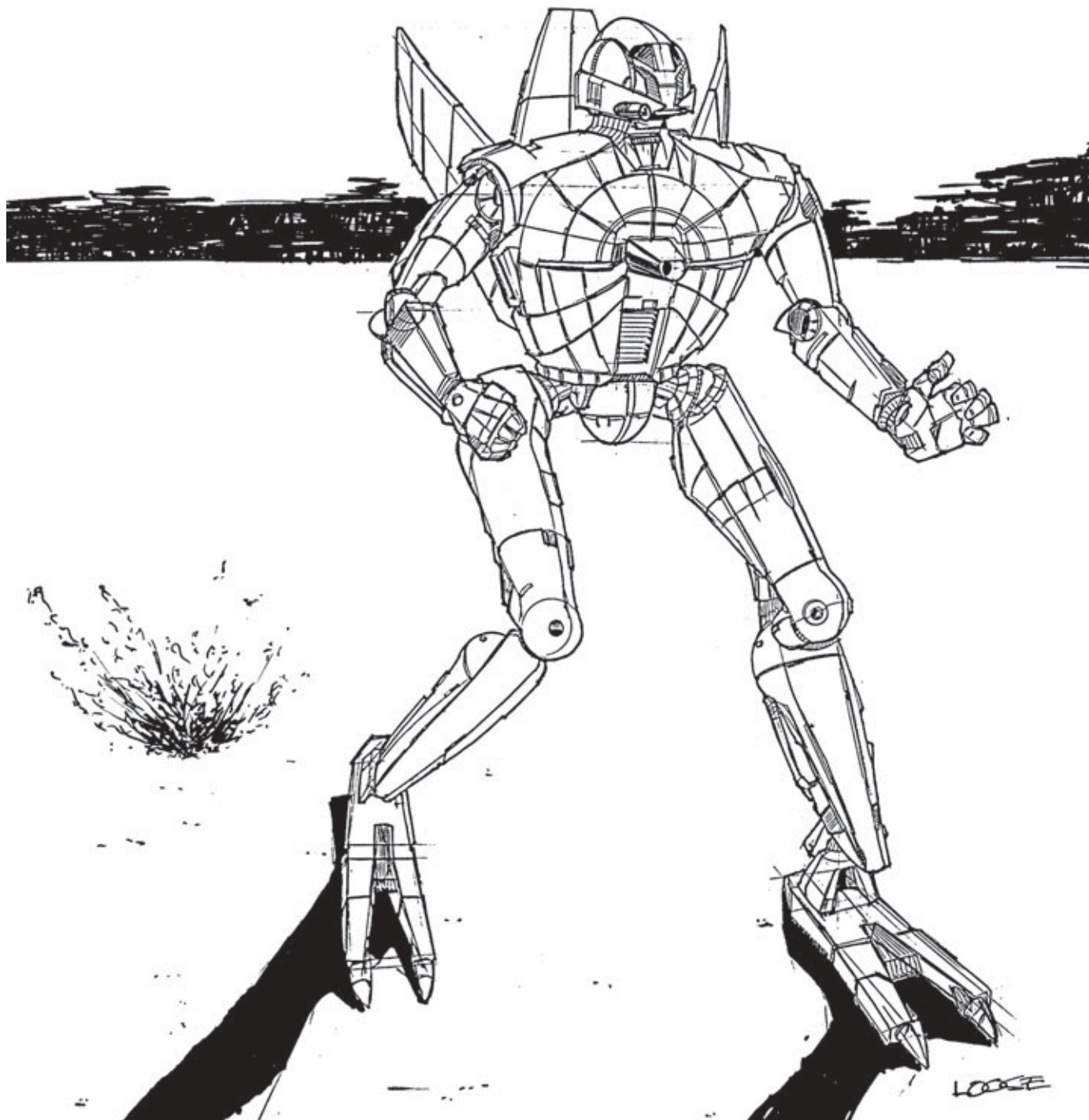

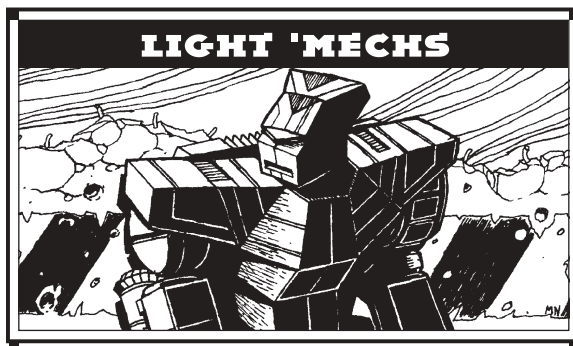

Mass: 30 tons

Chassis: Republic-R

Power Plant: Leenex 60

Cruising Speed: 21 kph

Maximum Speed: 32 kph

Jump Jets: Pitban 6000

Jump Capacity: 60 meters

Armor: Durallex Medium

Armament:

1 Emperor-B Autocannon

1 Harmon Small Laser

Manufacturer: Orgus Industries

Primary Factory: Marcus (destroyed 2837)

Communications System: Dalban Interact

Targeting and Tracking System: Dalban Urban

Overview

Called upon to produce an effective light 'Mech for city fighting, Orgus Industries replied with the *UrbanMech*. Cheap to produce but potent in its assigned duties, the 'Mech was manufactured in large numbers from 2675 until the destruction of the Orgus Industries production lines, and many have survived the Succession Wars.

Capabilities

At 30 tons, the *UrbanMech* is a mid-range light 'Mech, meaning its slow speed would appear to be a distinct liability. But the 'Mech was designed for city combat, an environment that severely limits many other designs. Six tons of Durallex armor provides protection that rivals many medium-class BattleMechs, and the *UrbanMech's* low, stocky profile presents opponents with a difficult target.

The Emperor-B Class 10 autocannon is a reliable design that is well suited to the *UrbanMech's* hit-and-run fighting style. Limited magazine capacity is a potential liability in a prolonged fight, and critics often note that, one way or another, an *UrbanMech* is good for about two minutes of combat.

A single Harmon small laser is the only backup to the Emperor-B. Only marginally effective, the laser can still persuade hostile infantry to keep their heads down.

Standard tactics call for *UrbanMech* lances to split up into individual units and use buildings as cover to snipe at the enemy. Then the units fall back to regroup along the next line of defense and re-arm.

Deployment

The *UrbanMech* was used by the Star League to suppress urban guerrillas and hostile light 'Mechs in heavily populated areas. During the Succession Wars the 'Mech was considered more of a liability than an asset. The Great Houses relegated the humble *UrbanMech* to garrison duty or stripped it for parts. Ironically this attitude ensured that the *UrbanMech* was spared the carnage of the First and Second Succession Wars. While many of its contemporaries have been consigned to the pages of history, the *UrbanMech* remains in service.

Unlike the other Successor States, the Capellan Confederation maintains a large number of *UrbanMechs* in its front line forces. Ravaged during the Fourth Succession War, the Confederation is desperate for any BattleMech to put on the field. After the Fourth Succession War, the St. Ives Armored Cavalry and Tikonov Republican Guards inherited many *UrbanMechs*.

A single battalion of Lothar's Fusiliers (then a regiment of Liao's Chesterton Reserves) defended the storehouses at Fort Lyons on Carver V. In 2862 Marik's Fourth Regular Hussars made a grab for the *Atlas* and *Victor* parts stockpiled there, but their lead company ran into Fusilier *UrbanMechs* as it moved into the city. Supported by armor and infantry, the Liao *UrbanMechs* used classic tactics, engaging the heavy 'Mechs with pop-up fire, then vanishing among the buildings. The Hussars wound up with a major fight on their hands, and the assault bogged down.

The Marik attackers eventually pushed the Liao forces back but sustained heavy losses and withdrew with only a fraction of the booty they had anticipated.

Variants

The only major variant of the *UrbanMech* is an armless version. Despite possessing a further streamlined profile, the disadvantages of this design proved fatal, and so very few have survived to the present. House Liao has a few *UrbanMechs* with an Emperor-Zeta Class 20 autocannon, known as the UM-60L. The weapon's heat and mass have kept the 'Mech from gaining any great popularity.

Notable MechWarriors

MechWarrior Gordon Stuart: Seeing intense city combat as a member of Lothar's Fusiliers of the Chesterton Reserves, MechWarrior Stuart twice refused promotion in favor of remaining with his urban defense lance and his battered but serviceable *UrbanMech*, the "*Gallant*."

Stuart made no secret of his contempt for House Kurita. This attitude proved prophetic with the Combine's failure to aid its Liao allies when the Federated Suns juggernaut romped triumphantly through the Confederation in 3028. Bitter and disillusioned, Stuart and many of his comrades abandoned the Confederation and joined Tikonov's First Republican Guard when Pavel Ridzik formed the (short-lived) Tikonov Free Republic.

Commander Patricia Wellseley: This able officer commands an urban defense lance in the St. Ives Armored Cavalry. Although considered by many to be something of an eccentric (she collects teapots with passionate enthusiasm and tends toward bizarre reading habits), her performance as lance commander has been flawless. Her actions in defense of New Kolis on Maladar against a Davion raiding party have been used as examples of textbook tactics.

As with many MechWarriors, Wellseley's quirks are tolerated, even encouraged by superiors eager to find a competent commander.

UM-R60 URBANMECH

Type: **UrbanMech**

Technology Base: Inner Sphere

Tonnage: 30

Battle Value: 504

Equipment

		Mass
Internal Structure:		3
Engine:	60	1.5
Walking MP:	2	
Running MP:	3	
Jumping MP:	2	
Heat Sinks:	11	1
Gyro:		1
Cockpit:		3
Armor Factor:	96	6

	Internal Structure	Armor Value
Head	3	9
Center Torso	10	11
Center Torso (rear)		8
R/L Torso	7	8
R/L Torso (rear)		4
R/L Arm	5	10
R/L Leg	7	12

Weapons

and Ammo	Location	Critical	Tonnage
AC/10	RA	7	12
Ammo (AC) 10	RT	1	1
Small Laser	LA	1	.5
Jump Jets	CT	2	1

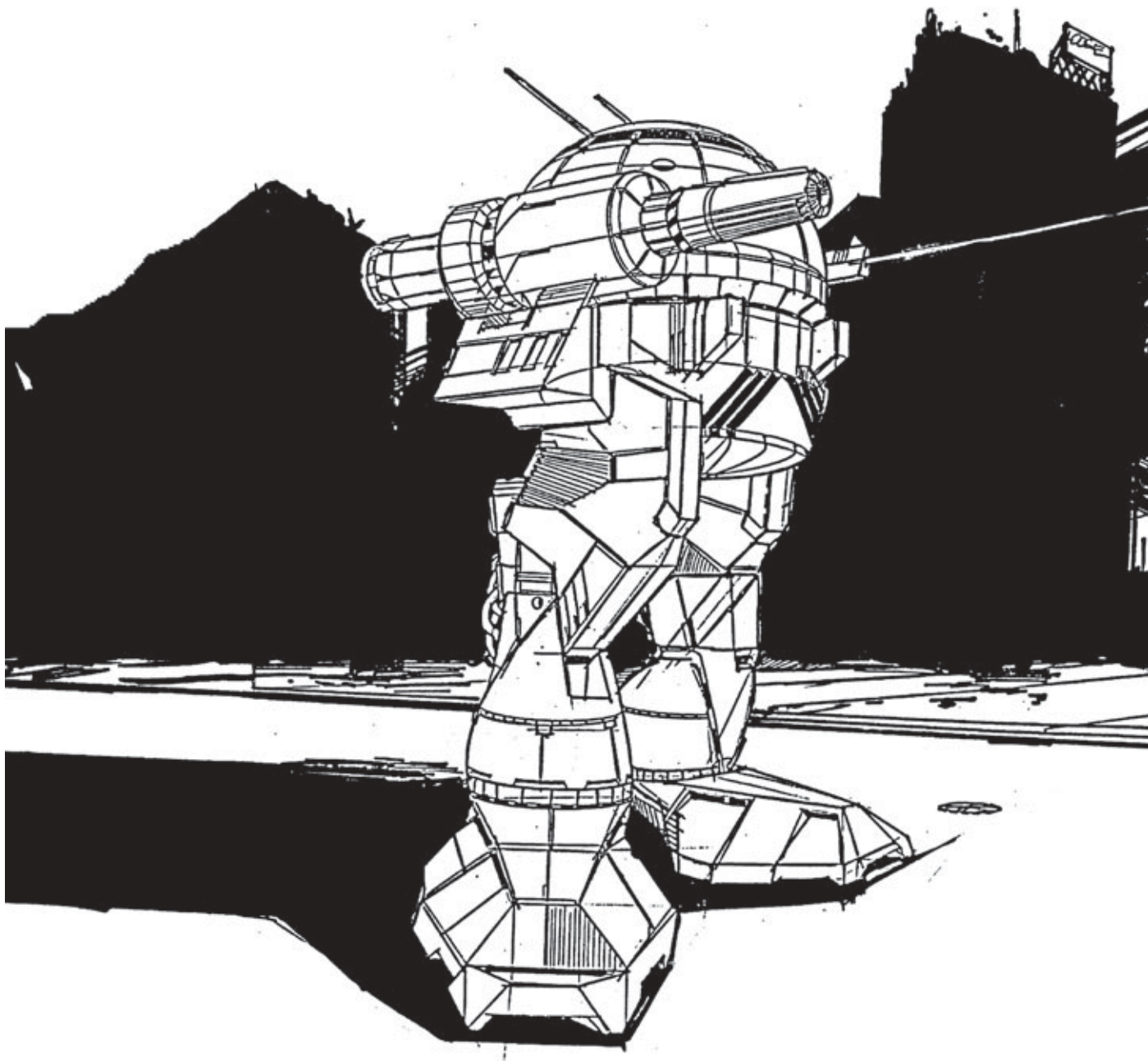

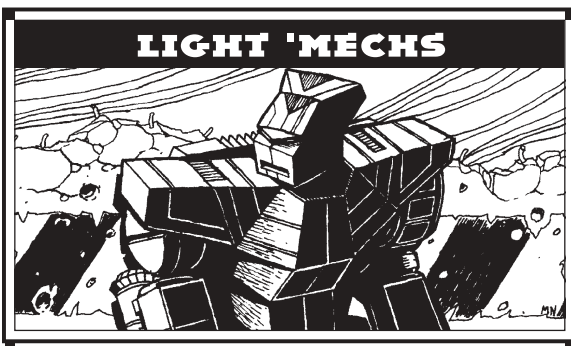

Mass: 35 tons

Chassis: Argile H/09

Power Plant: Omni 210

Cruising Speed: 64 kph

Maximum Speed: 97 kph

Jump Jets: Luxor Load Lifters

Jump Capacity: 180 meters

Armor: Livingston Ceramics

Armament:

2 Magna II Medium Lasers

2 Deprus RF Machine Guns

4 Purity L-series Flamers

Manufacturer: Coventry Metal Works

Primary Factory: Coventry

Communications System: Cyclops 14

Targeting and Tracking System: Tansech C30-97

Overview

Conceived primarily as an indirect assault unit, the *Firestarter* was originally constructed by Argile Technologies of Skye from 2550 through early 2776. It was successfully marketed as a highly mobile incendiary 'Mech, and the *Firestarter* was constructed in great numbers before the Succession Wars began. Most 'Mech regiments contained a number of FS9s, and spare parts could be found at all repair depots. Over half of the original production run survived in good condition. Because the FS9 is a popular 'Mech among militia and House units, Argile continued to produce spare parts and new *Firestarters* until the catastrophic destruction of the Argile plant and headquarters during the Third

Succession War. Coventry Metal Works picked up production when Argile indicated it would not rebuild the shattered factory.

Capabilities

The *Firestarter* was rarely attached to a front-line lance and is usually assigned to a company or regiment. It would then be deployed to support an attack group or to scout wooded terrain.

While a capable threat against other light 'Mechs, the *Firestarter's* specified loadout can do little against heavier opponents. However, the ability to set fires made it an invaluable supporting 'Mech. Skillfully placed blazes could rout an enemy force, break lines, and corner 'Mechs—not to mention threaten even the biggest tanks with the one thing those crews fear most: a fiery demise trapped in their tank. An entire series of tactics was developed around creating and spreading wildfires. *Firestarter* pilots are particularly fond of setting dense woods afire while enemy 'Mechs advance through them, or igniting buildings that are sheltering enemy units. If an engagement goes sour, a *Firestarter* can create fire and smoke to cover a retreat and hamper pursuit.

Firestarters also work well as scouts, especially when combined with *Vulcans*. The 'Mech's speed, armor, and maneuverability give it decent protection in the field. Not only can it map terrain as it travels, it can also clear away wooded areas or heavy brush that the enemy might use as defensive positions.

Firestarters were also primarily responsible for scorched-earth missions carried out in the early days of the Succession Wars. On today's modern battlefield, however, that tactic is extremely rare. It is used only when long-term victory is impossible or when a target is too valuable to fall into enemy hands.

Deployment

Because the *Firestarter* was common in all 'Mech forces before and during the Succession Wars, there was no real shortage of these 'Mechs. After the Fourth Succession War, many *Firestarters* were incorporated into light and even medium 'Mech lances to replace more costly units that have been destroyed or taken out of action.

Variants

A number of variants of the *Firestarter* were built during the period Argile still operated on Skye, though the FS9-H remained the most popular and widely used. One "variant" that has ceased production is the original *Firestarter* design, which mounted small lasers instead of machine guns and had a ton more armor. A companion model, the FS9-K, mounted two flamers, a large laser, and two small lasers. However, the -H model proved to be so popular that it was Argile's dominant product after 2703. Argile began testing a scout variant in the early 2890s that replaced all the flamers with two small lasers and three additional tons of armor. Tagged as the FS9-M (and nicknamed the "*Mirage*"), the design only saw a year of production before the catastrophic battle that laid waste to the Argile plant and Skye's capital. The Skye Rangers usually field a lance of FS9-Ms that are painted with one black arm to commemorate the immense destruction and tragedy of that week.

Notable MechWarriors

Force Commander Tybalt Roland: Assigned to the Oriente Hussars, Roland commanded a scout company during a raid on Timbiqui. After being cut off from their DropShips three days into the fight, Roland managed to build a raging forest fire and redirect it toward the city of New Bombei. The tactic worked, as the waiting Lyran forces were immediately recalled to help in firefighting duties. Roland managed to evacuate his entire unit with no losses in the ensuing chaos and left the Lyrans to discover that he had prepared several effective fire breaks that contained the fire three kilometers outside of the city.

FS9-H FIRESTARTER

Type: **Firestarter**

Technology Base: Inner Sphere

Tonnage: 35

Battle Value: 692

Equipment

		Mass
Internal Structure:		3.5
Engine:	210	9
Walking MP:	6	
Running MP:	9	
Jumping MP:	6	
Heat Sinks:	10	0
Gyro:		3
Cockpit:		3
Armor Factor:	88	5.5
	<i>Internal Structure</i>	<i>Armor Value</i>
Head	3	9
Center Torso	11	13
Center Torso (rear)		6
R/L Torso	8	11
R/L Torso (rear)		5
R/L Arm	6	6
R/L Leg	8	8

Weapons

and Ammo	Location	Critical	Tonnage
Flamer	RA	1	1
Flamer	CT	1	1
Flamer	LA	1	1
Flamer	CT (R)	1	1
Medium Laser	RA	1	1
Medium Laser	LA	1	1
Machine Gun	RT	1	.5
Machine Gun	LT	1	.5
Ammo (MG) 200	RT	1	1
Jump Jets	RT	3	1.5
Jump Jets	LT	3	1.5

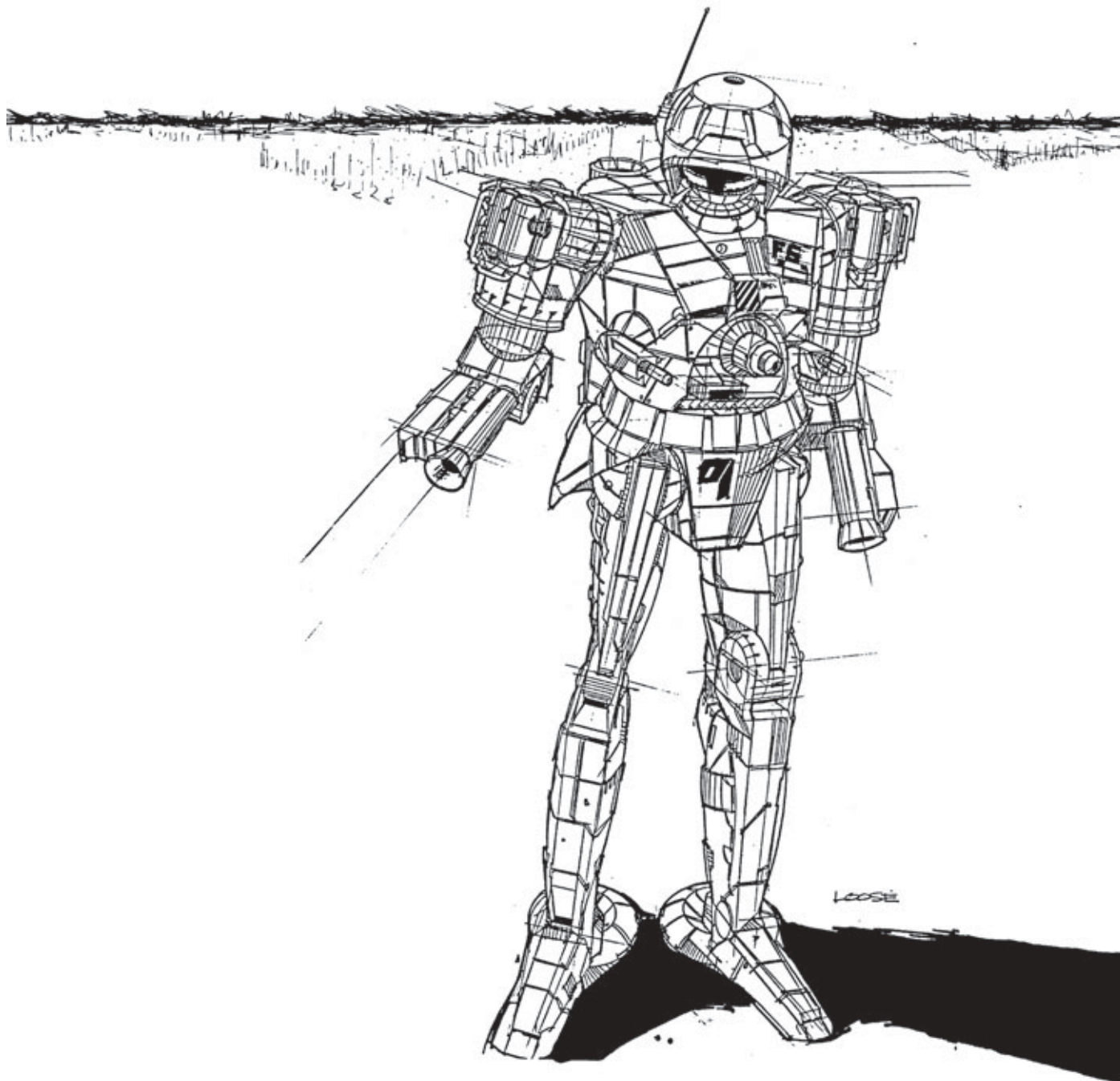

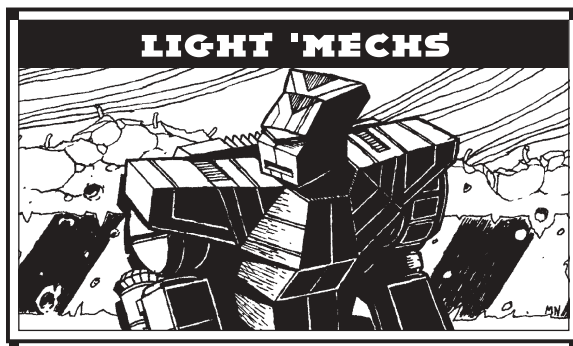

Mass: 35 tons
Chassis: Diplan Scout-A
Power Plant: Magna 245
Cruising Speed: 75 kph
Maximum Speed: 118 kph
Jump Jets: Smithson Lifters
Jump Capacity: 150 meters
Armor: Starshield
Armament:
 4 Argra 3L Medium Lasers
 1 Thunderstroke SRM 4
Manufacturer: Luthien Armor Works
Primary Factory: Luthien
Communications System: Dawson III
Targeting and Tracking System: Bk-309

Overview

Unlike most other BattleMech designs before the 31st century, the *Jenner* was a source of national pride for a single state, the Draconis Combine, as opposed to a 'Mech used by the Star League. Designed, produced, and used solely by House Kurita, the *Jenner* became synonymous with that interstellar power. It would take years, however, before the project came into fruition, as the targeting and weapon systems had countless problems during the testing stage. Later, the *Jenner's* prominent role in the Kentares Massacre would tarnish its reputation.

Many observers joked that the original weapons load-out was an experiment to install a turret from scrapped

Union DropShip onto a BattleMech. However, the turret-mounted lasers proved to be too fragile for production and were stripped out, replaced with extra armor, and new medium lasers were installed in the arms. Later, the developers would replace the added armor with a short-range missile system to augment firepower.

Capabilities

Despite the *Jenner's* fast and nimble design, several oversights have hampered the 'Mech's original mission as a raider and guerrilla fighter. Lack of hands forces the 35-ton machine to be accompanied by other designs to pick up any captured spoils, and its four tons of armor has been derided for its "less than paper-thin" quality when compared to BattleMechs of similar tonnage.

Its speed and armament, however, have no such deficiencies. A pair of Argra 3L medium lasers in each arm gave the *Jenner* an impressive throw-weight in combat. The Thunderstroke SRM 4 pack, which replaced the original large laser, works just as effectively against BattleMechs and vehicles, especially when the single ammo bin is equipped with inferno rounds. Combined, these weapons give the *Jenner* more firepower than most other light BattleMechs in existence and a number of medium BattleMechs as well. Though an "alpha strike" would leave a *Jenner* running hot, MechWarriors were trained to use their impressive jump capability of 150 meters to buy time for their machine to cool down.

Deployment

The design was one of the first to be developed and produced after Kerensky's exodus, which allowed House Kurita to have exclusive access to the design for over fifty years until the Succession Wars took their toll. Shortly thereafter, the remaining Successor States all had small numbers of the light BattleMech.

Despite the destruction of the last *Jenner* factory in 2848, nearly every battalion in the Draconis Combine fielded at least one *Jenner* within its ranks as late as the end of the War of 3039, and every AFFS regiment stationed along the Draconis Combine border had at least one *Jenner* as well.

A favorite tactic was for a lance of *Jenners* (including one or two equipped with inferno SRMs) to gang up and alpha strike a much heavier BattleMech at the same time. If the target survived the initial salvo, it was typically badly damaged and running hot due to the infernos, allowing the *Jenners* to leap away in different directions to cool down. The *Jenners* would regroup seconds later to repeat the tactic. This was a slight revision from the discredited theories of Captain Mercer Ravannion, who strongly believed a horde of ultralight BattleMechs could overwhelm a much heavier opposing force. Once commanders began using the heavier *Jenner* as the preferred model, successes in such tactics began to occur on small scales. [EDITOR'S NOTE: *Gunji-no-Kanrei* Theodore Kurita made rebuilding the *Jenner* line on Luthien a top priority following the agreement with ComStar, but the lengthy process and inexperience of Combine engineers prevented the line from re-opening until 3046.]

Variants

The only variant known to exist before the discovery of the Helm core is the rarely seen JR7-F model without the SRM 4. Carrying more armor, these have had more success as raiders. None of the original prototypes with the large laser are still functional, though a few pilots have attempted, unsuccessfully, to modify their machines to carry a large laser without the turret.

Notable MechWarriors

Chu-i Hugo Green: A descendant from the man who led the death squads during the Kentares Massacre, Green inherited the black-and-red *Jenner* that was used to kill many of the civilians there. Green would successfully pilot it until the Ronin Wars, where as part of Marcus Kurita's personal guard on Predlitz, he committed *seppuku* after allowing a Loki assassin to slip past and murder his commander. The *Jenner* was destroyed beyond any repair or salvage afterward to erase the many stains of dishonor the machine carried.

JR7-D JENNER

Type: **Jenner**

Technology Base: Inner Sphere

Tonnage: 35

Battle Value: 875

Equipment

		Mass
Internal Structure:		3.5
Engine:	245	12
Walking MP:	7	
Running MP:	11	
Jumping MP:	5	
Heat Sinks:	10	0
Gyro:		3
Cockpit:		3
Armor Factor:	64	4
	<i>Internal Structure</i>	<i>Armor Value</i>
Head	3	7
Center Torso	11	10
Center Torso (rear)		3
R/L Torso	8	8
R/L Torso (rear)		4
R/L Arm	6	4
R/L Leg	8	6

Weapons

and Ammo	Location	Critical	Tonnage
SRM 4	CT	1	2
Ammo (SRM) 25	RT	1	1
2 Medium Lasers	RA	2	2
2 Medium Lasers	LA	2	2
Jump Jets	RT	2	1
Jump Jets	LT	2	1
Jump Jet	CT	1	.5

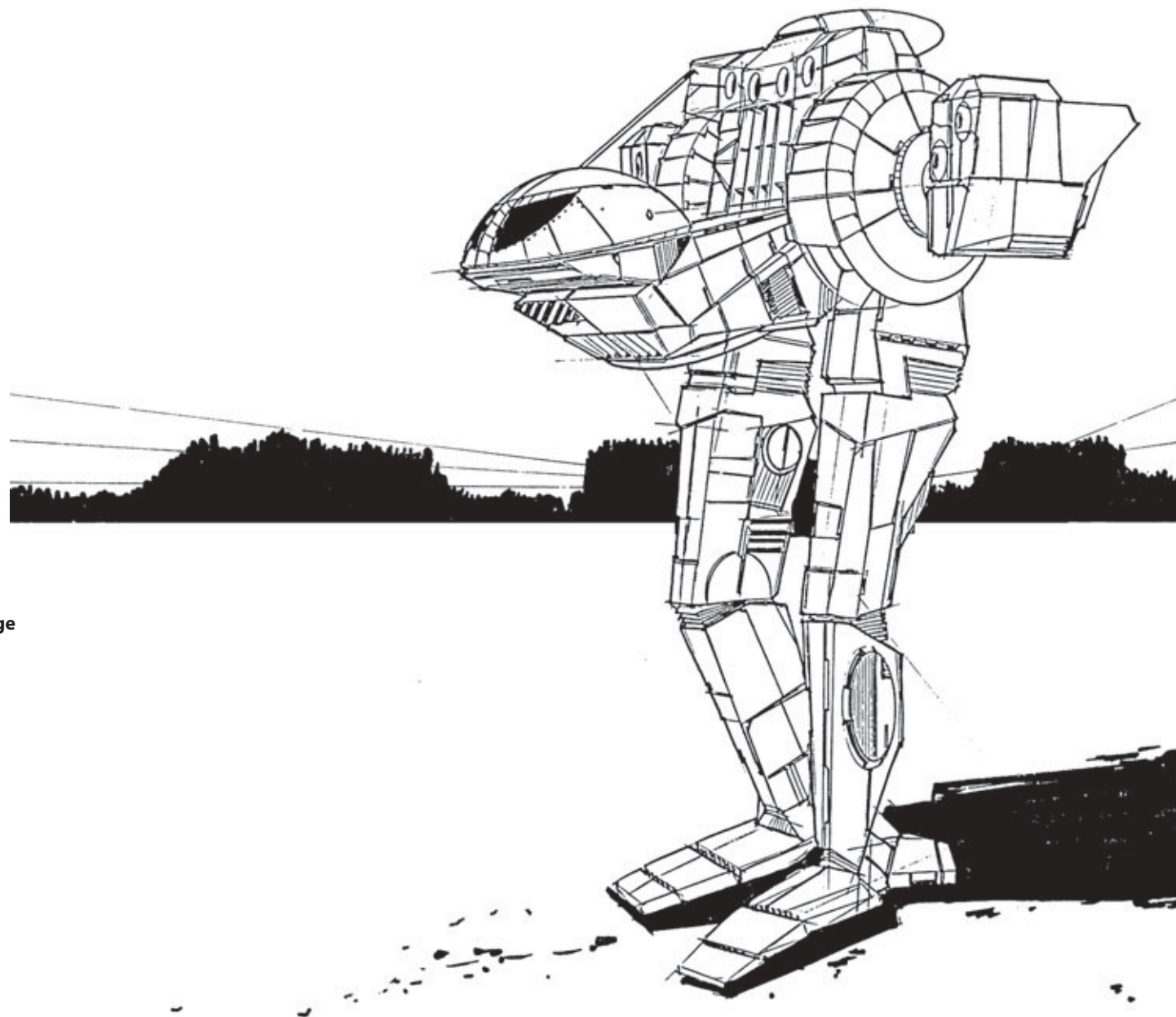

LOOSE

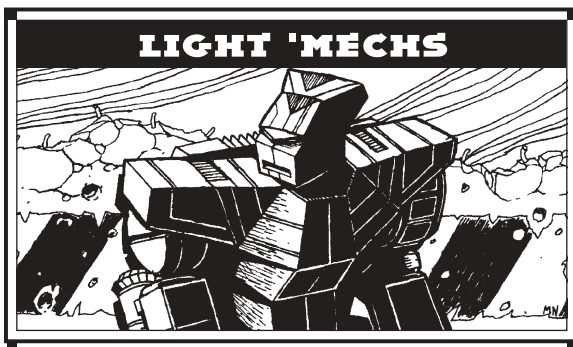

Mass: 35 tons

Chassis: Alshain 56-Carrier

Power Plant: Leenex 140

Cruising Speed: 43 kph

Maximum Speed: 64 kph

Jump Jets: Lexington Lifters

Jump Capacity: 120 meters

Armor: Maximillian 42

Armament:

1 Telos-4 Short Range Missile Delivery System

1 Lord's Light PPC

Manufacturer: Alshain Weapons

Primary Factory: Alshain, New Oslo

Communications System: Sipher CommCon CSU-4

Targeting and Tracking System: Cat's Eyes 5

Overview

Originally conceived and designed as a fire-support vehicle for reconnaissance units, the prototype *Panther* was first built for the Star League during the waning years of the Cameron dynasty. Alshain Weapons began producing *Panthers* shortly after being commissioned in 2739 to build them; League troops were the initial users of the 'Mech in fighting renegade bandits along the Periphery borders.

After the disastrous Battle of St. John in 2759, the Star League re-evaluated the design. With the high-maintenance Tronel large laser system generating enormous amounts of heat for limited power and range, the design lagged as a backbone support unit despite its hardness and maneuverability. Star League designers tested the new

Lord's Light PPC system and found the heat-to-effectiveness ratio well above acceptable limits; Alshain Weapons immediately ceased production of the PNT-8Z and began installing the new PPC as well as a new armor composite that strengthened the 'Mech's durability.

After the fall of the Star League, the Combine inherited the original Alshain Weapons' *Panther* factories [EDITOR'S NOTE: Both since lost to the Free Rasalhague Republic and the Clans and replaced with others.] With the *Panther* factories inside the Combine's border, combined with the fact that many Kuritan warriors took to the design, the Draconis Combine was the only House that used the *Panther* in any significant numbers during the Succession Wars.

Capabilities

The *Panther's* main function is as fire support for light and fast-moving 'Mechs. The 'Mech has kept this battlefield role for nearly 300 years, providing covering fire for mobile units in mid-maneuver, whether toward or away from the enemy. Oftentimes, lance commanders can be found in a *Panther* due to its ruggedness and PPC firepower.

Its PPC is unusual for a 'Mech of its size. The Lord's Light combines the firepower of a standard PPC with lightness and flexibility for an arm-carried weapon. If caught at short-range, the *Panther* carries four SRM tubes with enough ammo to last for a few heated firefights.

Star League pilots discovered early on that the *Panther* was well-suited for the dirty tactics required in city fighting. The 'Mech can move easily through the more restricted spaces of a city, while its PPC gives it the chance of disabling all but the heaviest of opponents with a few well-aimed shots. From rooftop ambushes to alleyway-style "muggings," the *Panther* has gained quite a reputation in urban arenas, so much so that Lyran pilots began calling it the "Alley Cat."

Deployment

Panthers are predominately found among DCMS forces, mainly due to the fact that the Alshain Weapons factories were located within Combine space. Initially considered a poor choice for light 'Mech duties like reconnaissance and scouting, the Combine's warriors eventually warmed to it.

With demand for parts and replacements continuing to rise, AW opened a new *Panther* facility on Jarett to handle the workload.

Since the Free Rasalhague Republic's formation in 3034, the *Panther* has rapidly become a mainstay of the Royal KungsArmé, primarily because AW's largest *Panther* complex is located on New Oslo.

Panthers found in the LAAF or AFFS are mainly battlefield salvage from tangles with the DCMS. Since replacement parts were found only in the Combine, pilots of these machines often ran them into the ground before sending them to the scrapyards for recycling or selling them to the mercenary secondary market.

Variants

No variants existed beyond the ancient PNT-8Z "prototypes" produced in limited numbers during the days of the Star League, which mounted an ancient, heat-problematic Tronel large laser. When League designers recommended a change of weapon to the PPC due to the maintenance and heat problems with the Tronel, the *Panther* also lost a heat sink and ton of armor to compensate for the heavier particle cannon. While the know-how to replicate the original sophisticated fire control and communications equipment was lost by Alshain Weapons, Combine engineers worked with the company to support the line, which is dominated by production of the PNT-9R.

Notable MechWarriors

Tai-sho Minobu Tetsuhara: Assigned as liaison officer to the Wolf's Dragoons, he also commanded the Ryoken regiment; an experiment to infuse a DCMS regiment with the Dragoon's unorthodox tactics. Tetsuhara, despite the usual samurai belief, accepted the Dragoons as superior warriors and friends and they responded by willingly teaching the Ryoken. In 3028, as House Kurita sought desperately to hold on to the Dragoons after their contract expiration, Minobu was put into an untenable position, forced to face the Dragoons on Misery...and lost. True to his samurai heritage, Minobu absolved the stain on the Ryoken by committing *seppuku*.

PNT-9R PANTHER

Type: **Panther**

Technology Base: Inner Sphere

Tonnage: 35

Battle Value: 769

Equipment

		Mass
Internal Structure:		3.5
Engine:	140	5
Walking MP:	4	
Running MP:	6	
Jumping MP:	4	
Heat Sinks:	13	3
Gyro:		2
Cockpit:		3
Armor Factor:	104	6.5

	Internal Structure	Armor Value
Head	3	9
Center Torso	11	14
Center Torso (rear)		7
R/L Torso	8	10
R/L Torso (rear)		5
R/L Arm	6	10
R/L Leg	8	12

Weapons

and Ammo	Location	Critical	Tonnage
PPC	RA	3	7
SRM 4	CT	1	2
Ammo (SRM) 25	LT	1	1
Jump Jets	RL	2	1
Jump Jets	LL	2	1

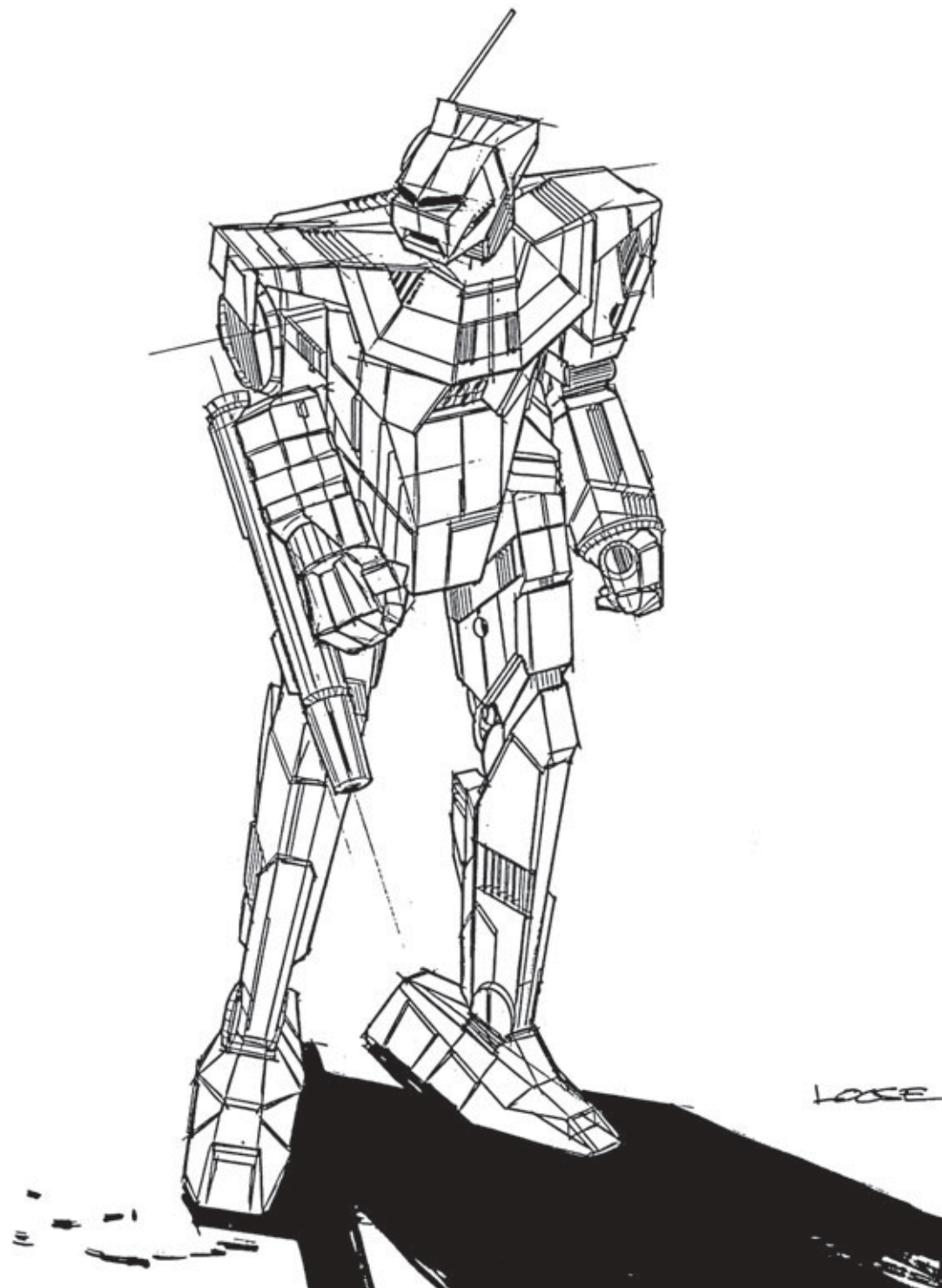

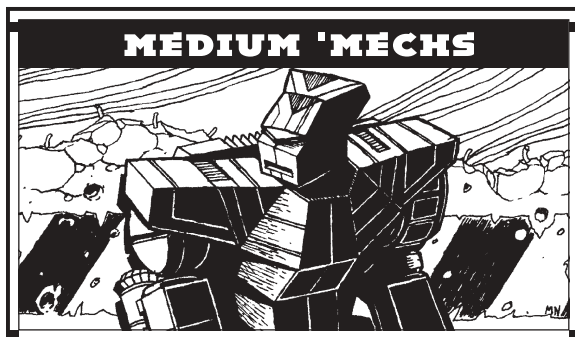

Mass: 40 tons
Chassis: Maltex 40
Power Plant: VOX 280
Cruising Speed: 75 kph
Maximum Speed: 118 kph
Jump Jets: Lox Lift Series 1
Jump Capacity: 210 meters
Armor: 100 AFVTA
Armament:
 1 Martell Medium Laser
 1 Holly-5 LRM Launcher
 1 Holly-2 SRM Launcher
Manufacturer: Maltex Corporation
Primary Factory: Errai (destroyed 2835)
Communications System: Garret T15 B
Targeting and Tracking System: Garret 500S

Overview

Considered by many military financial experts outside the Star League as more of a political pork project than a potent fighting machine, the *Assassin* nonetheless turned out to be a solid 'Mech in combat against light lances. In order to secure lucrative Star League contracts, however, the *Assassin* was over-hyped in several corporate circles, with exaggerated performance statistics and fudged budget approximations. Greasing a few palms, Maltex finally managed to secure the sought-after SLDF contracts. During production, the company cut corners on several design specifications, and after two of Maltex's *Assassin* plants came under investigation for numerous quality

control violations, the 'Mech's production rate slowed to a crawl. With lackluster firepower for its tonnage, the *Assassin* quietly fell into disuse or was shuffled to the Periphery and militia markets.

Capabilities

The *Assassin* was originally marketed as a heavier competitor against the numerous older *Wasps* and *Stingers* in use as reconnaissance and raider 'Mechs. The *Assassin* was able to defeat these lighter 'Mechs thanks to decent speed and maneuverability, excellent armor coverage (compared to the 'Mechs it was designed to fight against), and solid firepower. However, the over-reliance on consumable ammunition gave the *Assassin* limited long-term capability in extended campaigns. Nonetheless, it became a popular design for garrison and defense forces throughout the SLDF and Marik Militia.

The 'Mechs weaponry consists primarily of three systems: the long-range missile rack, the short-range rack, and the arm-mounted Martell medium laser. Because it can only carry a total of seventy-four salvos for both launchers, the design is limited in endurance unless assigned supply units for support. However, the biggest drawback to most pilots isn't the light ammo loads, it's the extremely tight cockpit—one of the most cramped cockpit designs in the Inner Sphere. During the *Assassin's* four hundred years of service history, Maltex has redesigned the cockpit cooling system dozens of times in efforts to offer more elbow room, but none of the attempts have been successful. The net result is a tight, uncomfortable ride for most pilots that limits in-cockpit time to half of most other standard designs; many ex-*Assassin* pilots have developed a history of back problems that plague them the remainder of their lives.

The only other problem with the *Assassin*—mainly those produced through to 2815—was the ammo feed system for the short-range missile rack. Due to chronic jamming, it usually failed during high-heat situations and could not be corrected except through complete disassembly in a mechanical bay. Holly finally introduced a new feed system under severe corporate pressure in 2815 and even funded several years of recall repairs; however, there are still a large number of privately owned *Assassins* that may still mount the defective system.

Deployment

From its introduction, only several hundred of the ASN-21s were produced by Maltex. Those *Assassins* in service were used sparingly due to a shortage of spare parts, though House Marik enthusiastically used the 'Mech late in the Third Succession War. The *Assassin* was nearly phased out of service after 3058 when an influx of new BattleMech models flooded the markets. Those that remained in service are typically family heirlooms with some degree of modification.

Variants

Only one true variant of the *Assassin* existed in 3039, though it was not designed or supported by Maltex. House Davion experimented with the addition of three small lasers at the price of a few jump jets and armor weight. The design was considered unsuccessful, with only three being retained on the official AFFS roster in the Capellan March Militia. Unofficially, however, rumors persisted for years that Prince Hanse Davion had a secret facility built near Panpour where work included the construction of the ASN-101 design. Circumstantial evidence bears this out as several CMM wargames had more than a few of these designs present, but official TO&Es never listed them. Detractors insist that the AFFS was using standard ASN-21s with fake weapon mounts in order to confuse and distract Maskirovka spies.

Notable MechWarriors

MechWarrior Dale Sandstrom: Assigned to House Marik's Fifth Regular Hussars as an infantryman when his *Archer* was destroyed, Sandstrom was never content to live as one of the Dispossessed. During an extended leave on his home planet of Sophie's World in 3011, he came across the remains of an *Assassin*. Using his entire life savings, he managed to get the 'Mech restored to functionality. After his departure from the Hussars, Sandstrom worked as a freelance bounty hunter in his *Assassin*, the "*DarkDeath*". Before his demise in 3033, he had accounted for nearly 45 "acquisitions." Rumors still persist that Sandstrom was killed when he ran afoul of a certain green-painted *Marauder*.

ASN-21 ASSASSIN

MEDIUM 'MECHS

117

Type: **ASN-21 Assassin**

Technology Base: Inner Sphere

Tonnage: 40

Battle Value: 749

Equipment

		Mass
Internal Structure:		4
Engine:	280	16
Walking MP:	7	
Running MP:	11	
Jumping MP:	7	
Heat Sinks:	10	0
Gyro:		3
Cockpit:		3
Armor Factor:	72	4.5

	Internal Structure	Armor Value
Head	3	8
Center Torso	12	12
Center Torso (rear)		4
R/L Torso	10	10
R/L Torso (rear)		2
R/L Arm	6	6
R/L Leg	10	10

Weapons

and Ammo	Location	Critical	Tonnage
Medium Laser	RA	1	1
LRM 5	RT	1	2
Ammo (LRM) 24	RT	1	1
SRM 2	LT	1	1
Ammo (SRM) 50	LT	1	1
Jump Jet	CT	1	.5
Jump Jets	RT	3	1.5
Jump Jets	LT	3	1.5

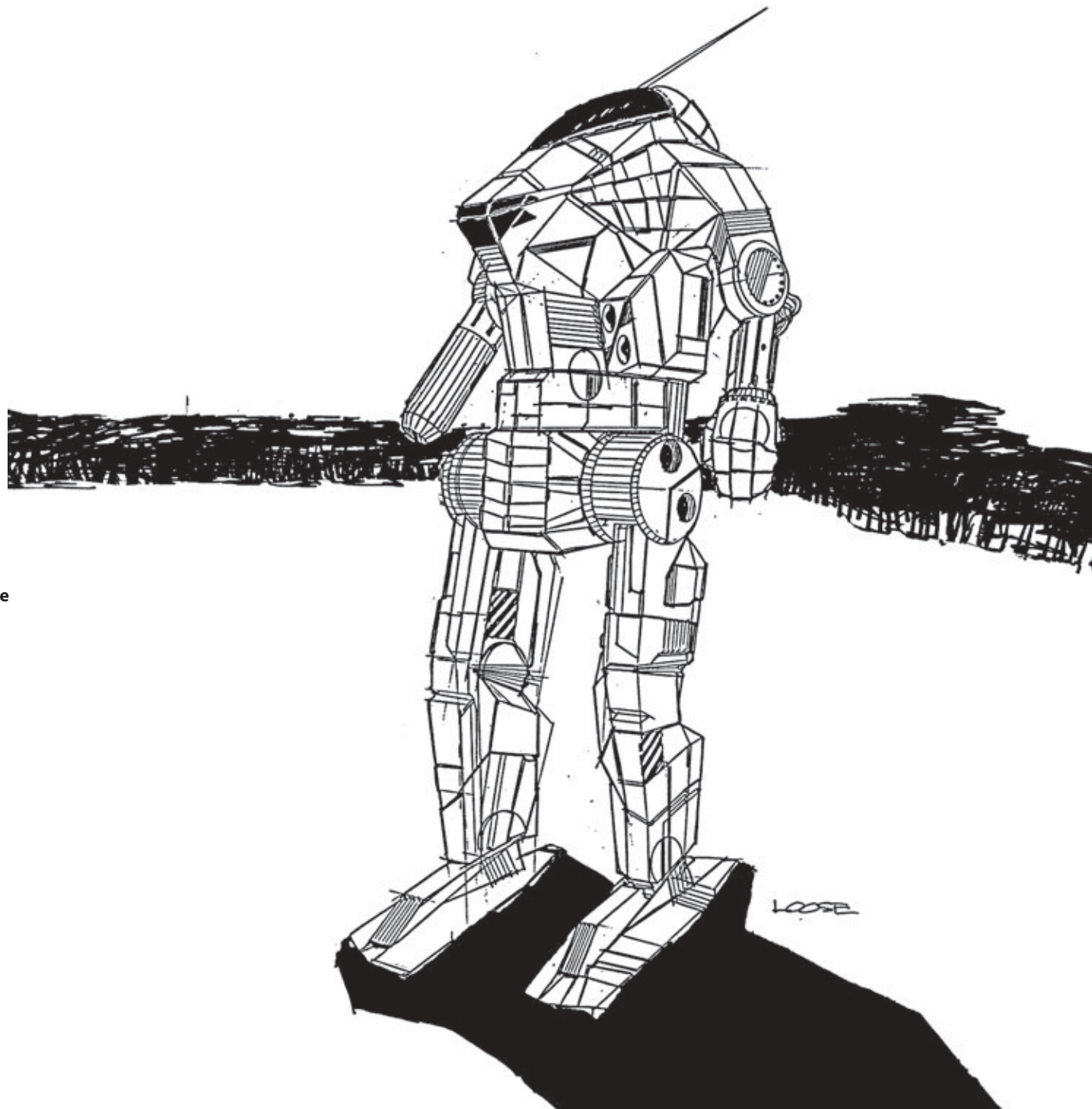

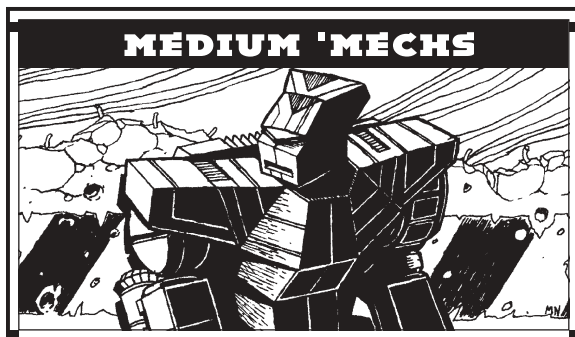

Mass: 40 tons

Chassis: Hartford 300

Power Plant: Pitban 320

Cruising Speed: 86 kph

Maximum Speed: 129 kph

Jump Jets: None

Jump Capacity: None

Armor: StarSlab/3

Armament:

2 Magna Medium Lasers

1 Magna 200 Small Laser

Manufacturer: Free Worlds Defense Industries

Primary Factory: Gibson

Communications System: Datacom 50

Targeting and Tracking System: Dynatec 1122

Overview

The original *Cicada* was designed by a small firm, HartfordCo, whose previous manufacturing experience had been confined to communications and targeting systems. Designed as a supplement or replacement for the popular *Locust* scout 'Mech, the *Cicada* found limited use by the Star League after its introduction in 2740. Although it was more expensive than the *Locust*, its increased mass gave it advantages that the Star League found useful, especially in physical combat.

Although HartfordCo's production facility on Bryant did not survive the Succession Wars, the discovery of the Helm Memory Core has allowed Free Worlds Defense Industries to increase production of the *Cicada* in their newly refurbished Gibson production facility.

Capabilities

The *Cicada's* prime assets are its speed and its lack of ammunition concerns. A massive Pitban 320 engine—which composes more than half of the *Cicada's* total mass—gives the 40-ton BattleMech a maximum speed of nearly 130 kph. A trio of lasers, two medium and one small, provide the *Cicada* with enough firepower to face the lighter 'Mechs, its intended targets. The lasers are embedded in the *Cicada's* armored torso, behind the heaviest protection the 'Mech mounts, but have limited firing arcs. An opponent who succeeds in getting behind the *Cicada* has little to fear.

Unfortunately, the rest of the 'Mech is only lightly armored. Its arms are vestigial—wings, really—and mount only minimal armor. The *Cicada's* legs, while strong enough to carry the 'Mech at phenomenal speeds, are under-armored as well.

Deployment

Although the number of *Cicadas* HartfordCo produced before its destruction was small, Bryant's location at the core of the Inner Sphere meant that the 'Mech was available to all five Successor States when the Houses fell upon the remains of the Terran Hegemony. These 'Mechs survived most of the Succession Wars, though in steadily decreasing numbers. The Free Worlds League was able to put the design back into very limited production. Since FWDI's refit, the Free Worlds League has become the 'Mech's largest user.

Extant *Cicadas* are often taken in for maintenance to have the substandard HartfordCo heat sinks replaced with newer, more reliable models. Three hundred years of Succession Wars have not been kind to the *Cicada's* systems, and many 'Mechs were lost to heat overload because of those balky heat sinks. A much-publicized incident on Oriente illustrated the problem very graphically, but it was not until 3029 that the Free Worlds League Military ordered all *Cicadas*, both in federal or provincial service, to be upgraded as soon as feasible.

Variants

HartfordCo produced two very limited variants; the first was an anti-infantry model, the CDA-2B, that carried a flamer in place of the small laser and half a ton of armor. The second was a more radical variant meant to threaten larger 'Mechs. Mounting a Donal PPC in the right torso and two machine guns in the legs, the CDA-3C used a smaller VOX 280 engine to offset the increased weight of the weapons. Few examples of these 'Mechs remain and are found in the arsenal of House Liao, which uses them in their training academies.

Notable MechWarriors

Captain John David John: Captain John first came to prominence as a *Cicada* pilot during engagements against the Draconis Combine on Kesai IV. For that action his *Cicada* was upgraded with new heat sinks and he was given command of a light lance. He went on to further distinguish himself during the siege of Tikonov in the Fourth Succession War. His lance was responsible for scouting the advance of the main Crucis Lancer thrust on the world, earning him the Gold Sunburst and an eventual promotion to captain.

During the Kurita counterattack on Klathandu IV in 3039, Captain John's company led the retreat from Pere Urcin when *Tai-sa* Nelson's attack struck. Although the retreat was scandalous, it was only the clear recon performed by Captain John's company that led the two battalions of the Seventh Crucis Lancers to safety.

Lieutenant Junior Grade Marshall Haupt: Currently assigned to FWDI as a test pilot for the new *Cicadas* being produced there, Lieutenant Haupt is something of a fire-brand. After graduating from the Allison MechWarrior Institute with that school's record for the lowest passing grade, he served a tour with the Second Oriente Hussars as a *Cicada* pilot. Reprimanded six times for disorderly conduct, he nevertheless proved himself the most proficient *Cicada* pilot in the regiment. When the draft came for the posting to Gibson, his company commander helped him pack.

CDA-2A CICADA

Type: **Cicada**

Technology Base: Inner Sphere

Tonnage: 40

Battle Value: 659

Equipment

		Mass
Internal Structure:		4
Engine:	320	22.5
Walking MP:	8	
Running MP:	12	
Jumping MP:	0	
Heat Sinks:	10	0
Gyro:		4
Cockpit:		3
Armor Factor:	64	4

	Internal Structure	Armor Value
Head	3	9
Center Torso	12	11
Center Torso (rear)		6
R/L Torso	10	6
R/L Torso (rear)		3
R/L Arm	6	4
R/L Leg	10	6

Weapons and Ammo

	Location	Critical	Tonnage
Medium Laser	RT	1	1
Medium Laser	LT	1	1
Small Laser	CT	1	.5

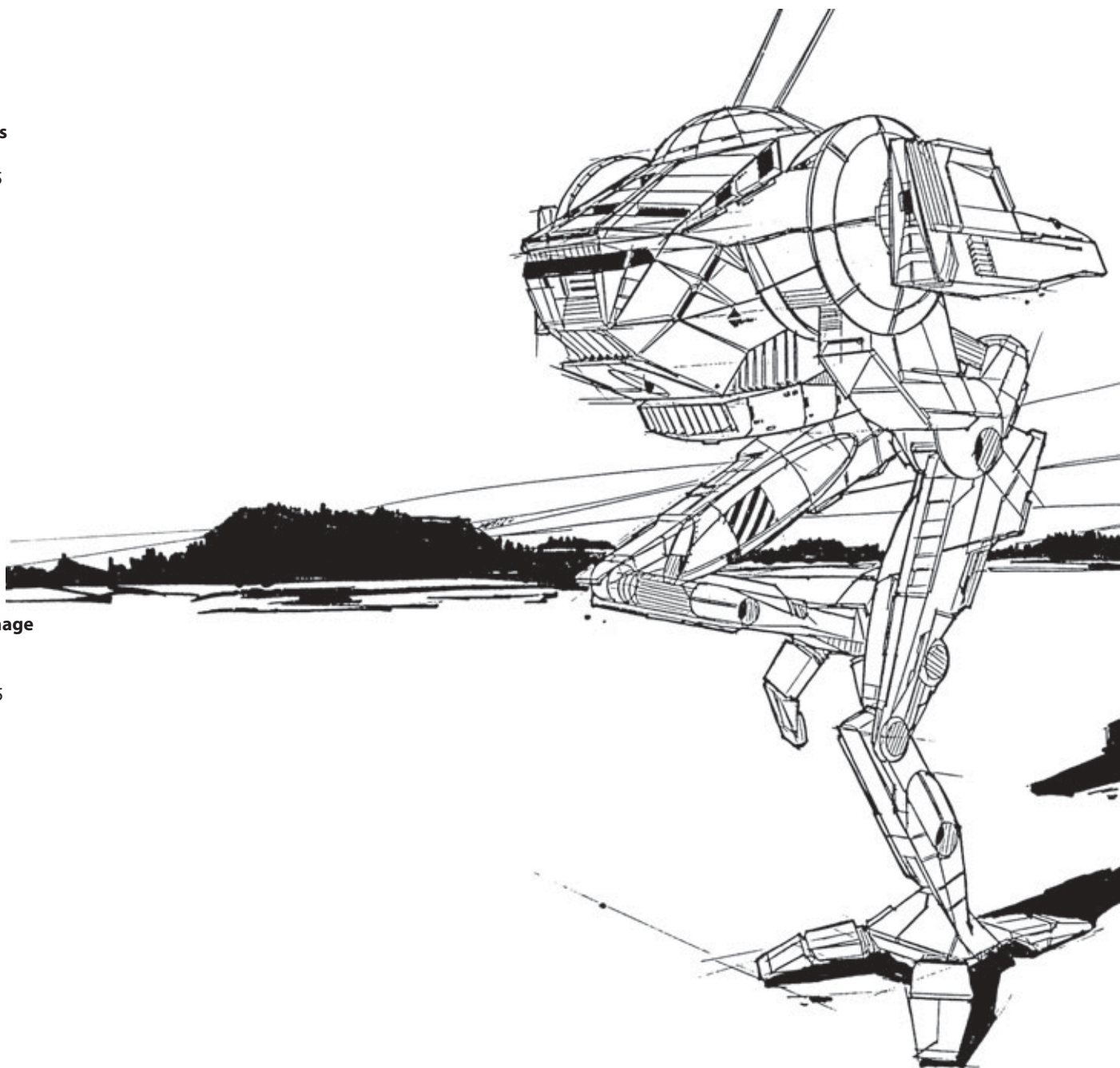

LOOSE

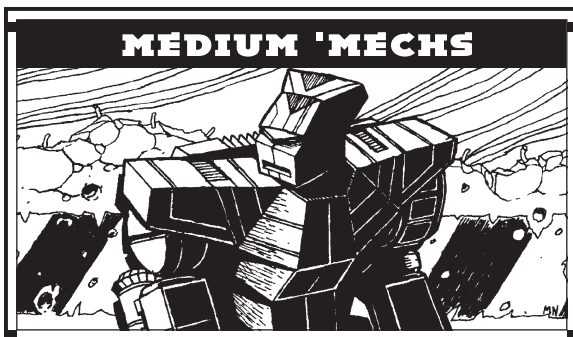

Mass: 40 tons

Chassis: Andoran Model III

Power Plant: Pitban 240

Cruising Speed: 64 kph

Maximum Speed: 97 kph

Jump Jets: Andoran Model JJII

Jump Capacity: 180 meters

Armor: Durallex Medium

Armament:

1 Armstrong Autocannon/5

2 Martell Medium Lasers

Manufacturer: Andoran Industries, Ltd.

Primary Factory: Bell (destroyed 2812)

Communications System: Raldon R1

Targeting and Tracking System: Sloane 220
Lockover System

Overview

In 2607, the SLDF commissioned the *Clint* from Andoran Industries, Limited, a minor BattleMech firm on Bell that secured its bid for the new design with cost-cutting design features. Although the resulting design would prove flawed, well over 300 were built before the fall of the Star League and the destruction of Andoran's factories.

The first *Clint* prototypes lacked jump jets but mounted a larger Buster-class autocannon with more ammunition. The chassis suffered from a number of stress issues that were expensive to repair, so Andoran downgraded the cannon to the lighter autocannon/5.

Capabilities

The *Clint* is an example of the "your ride was built by the lowest bidder" concept as Andoran undercut every other competitor to get the contract from the Star League. To make matters worse, the *Clint* uses very few standard components, requiring specific replacements when a part breaks down. This was a terrible burden on new *Clints* as the shoddy parts often didn't last a year, though it allowed Andoran to recoup the low sales price in the form of hefty service contracts. Particularly hard to replace is the gyroscope for the *Clint*. On the current market, the mechanisms are literally worth their weight in gold. Engineers who can look past the flaws caused by these poor-quality parts, however, generally agree that the overall design of the *Clint* is steady and reliable.

With a top speed of nearly 100 kph, the *Clint* can keep up with most recon units. Its jump jets allow it to traverse broken terrain and urban areas with ease. The Armstrong cannon isn't a stellar battlefield performer, but it has good range and is reliable. A pair of Martell medium gives the *Clint* punch at shorter ranges. The armor coverage on the *Clint* is good enough for an encounter, but the 'Mech isn't meant as a brawler. Among this average equipment, the Sloane 220 targeting system shines in battle. It is easy to use and gives the pilot some of the best battlefield data available.

Deployment

The destruction of the Andoran's facilities on Bell has added much confusion to the *Clint*'s history. Not only were the original design blueprints lost and the factory unable to make new *Clints*, but records of the number of *Clints* produced and variants other than the well-known prototype have been lost forever. *Clints* can be found almost everywhere, and the design is popular in the Periphery. In the Inner Sphere, the Federated Commonwealth and Capellan Confederation possess the most *Clints*.

A lance of *Clints* under Redjack Ryan has been used when Ryan's Rebels are on the offensive. The four 'Mechs reconnoiter enemy formations, normally withdrawing to report on large groups. However, when they encounter an opposing recon lance, they pursue. Few recon elements

can match the speed of four *Clints*, and units that can keep up rarely have the range of four autocannons. If the scouts flee, the Rebels pick them off one-by-one. If they stand and fight, the *Clints*' long-range fire wears their enemies down so that the close-range fighting is quick and decisive.

Variants

Most of the twenty *Clint* prototypes disappeared between various wars and the Exodus, but a few remain. Attempts to emulate this design by stripping down armor and weapons can be found. Another similar modification mounts a pair of lighter autocannons rather than the big Buster. Occasionally other variants of the *Clint* pop up, but because of the loss of Andoran's data, it is unclear if these are factory variants or field modifications.

Notable MechWarriors

Mechwarrior Janos Authur Denton III: While the Dentons have never explained how they got their *Clint*, JAD (as both Janos and the 'Mech were known) has shown he can use it well. As part of the Seventeenth Arcturan Guards, he has followed in his father's footsteps as an urban combat scout. He has even modified the family *Clint* with a large laser and more heat sinks for the close-in battles he often encounters. He particularly enjoys fighting Combine *Panthers*.

Leftenant Steven D. Olin: Leftenant Olin captured his *Clint* when fighting the St. Ives Armored Calvary in the Fourth Succession War. He even managed to ransom the pilot back for a spare gyro for the 'Mech. As part of the First Kittery Borderers, he often espouses his strange philosophies of a reduced military and less reliance on feudalism. On the battlefield, however, he focuses on the goal, and his scout lance is one of the best in the Borderers. Under his supervision, they scout out a large area and use a complex set of hit-and-run tactics if they come across enemy combatants.

CLNT-2-3T CLINT

Type: **Clint**

Technology Base: Inner Sphere

Tonnage: 40

Battle Value: 770

Equipment

Internal Structure:

Engine: 240

Walking MP: 6

Running MP: 9

Jumping MP: 6

Heat Sinks: 10

Gyro: 3

Cockpit: 3

Armor Factor: 72

Mass

4

11.5

0

3

3

4.5

Internal Structure

Armor Value

Head 3 9

Center Torso 12 11

Center Torso (rear) 4 4

R/L Torso 10 6

R/L Torso (rear) 4 4

R/L Arm 6 6

R/L Leg 10 8

Weapons

and Ammo

Location Critical Tonnage

AC/5 RA 4 8

Ammo (AC) 20 RT 1 1

Medium Laser CT 1 1

Medium Laser LT 1 1

Jump Jets RT 2 1

Jump Jet RL 1 .5

Jump Jets LT 2 1

Jump Jet LL 1 .5

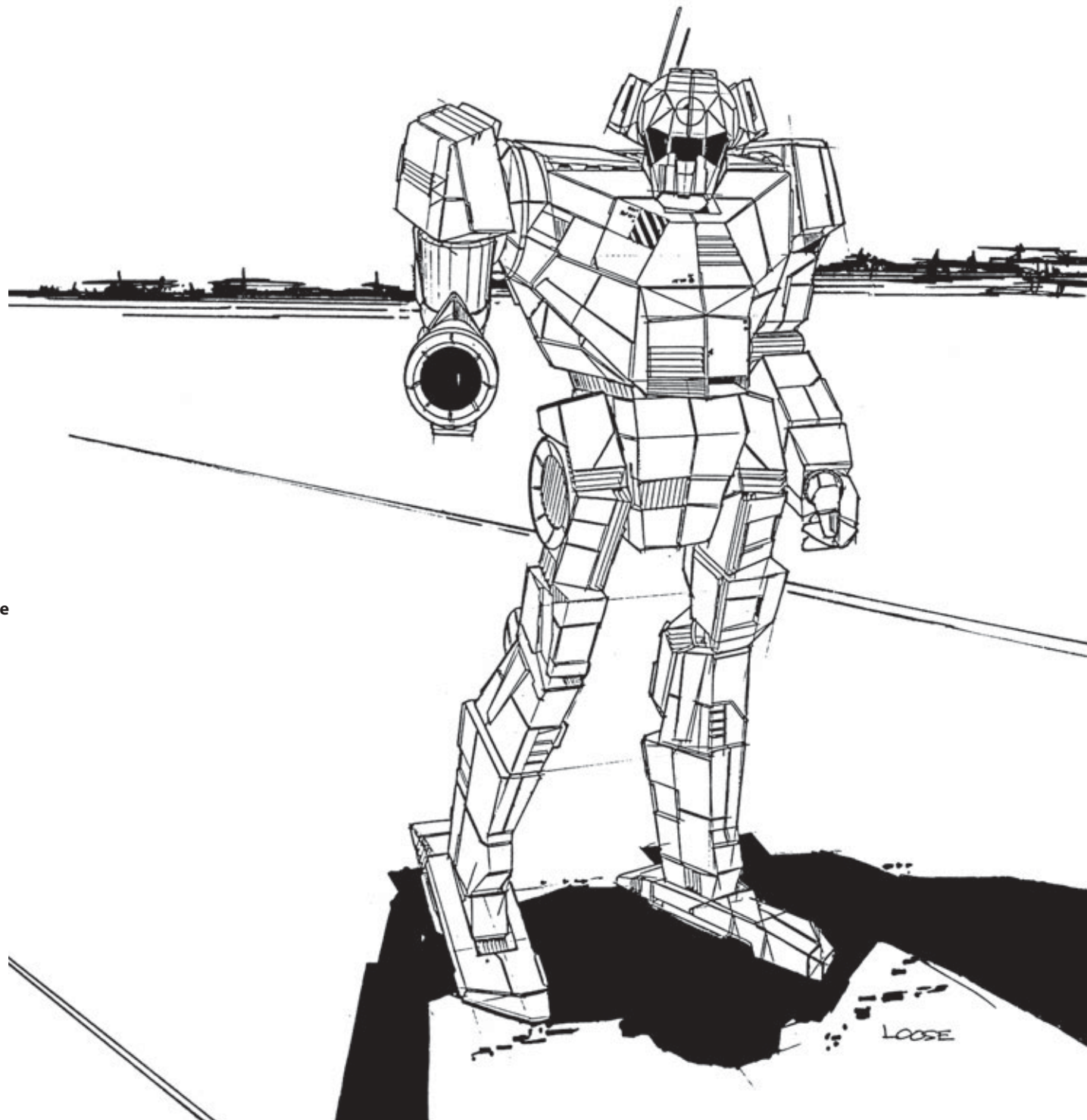

LOOSE

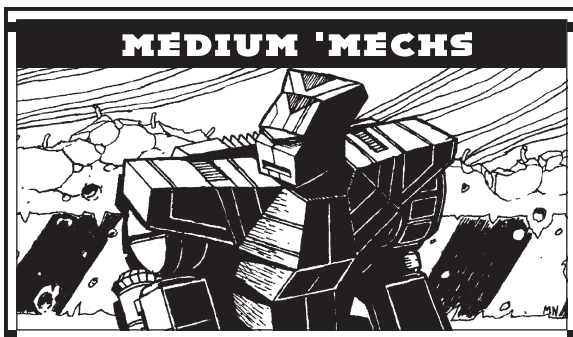

Mass: 40 tons

Chassis: Irian Chassis Class 40

Power Plant: Hermes 240

Cruising Speed: 64 kph

Maximum Speed: 97 kph

Jump Jets: None

Jump Capacity: None

Armor: Riese 456

Armament:

- 1 Oriente Autocannon
- 1 I.W.W. Medium Laser
- 1 Olympian Flamer

Manufacturer: Irian BattleMechs Unlimited

Primary Factory: Irian, Shiro III

Communications System: Irian E.A.R.

Targeting and Tracking System: Wasat Aggressor

Overview

Irian's military bread and butter, this 'Mech is the exclusive property of House Marik despite being based on the earlier, smaller *Hermes* just prior to the opening of the twenty-ninth century. Perhaps Irian's best selling point was the massive production line they had for the unit. With the military build-up following Kerensky's Exodus, this production capacity was vital. The first few carried a prototype autocannon spread across the torso, but rather than making it more durable, it was vulnerable to damage in any part of the torso. A temporary design with lasers was deployed to replace units in the field as designers reworked the *Hermes II* to consolidate the reliable Oriente autocannon into its current mount.

Capabilities

A heavy scout, the *Hermes II* has the tools to do the job. With a top speed of nearly 100 kph, the unit possesses the speed to stay ahead of any large military force. The autocannon and laser give the *Hermes II* decent firepower and range, while the Olympian flamer is not only fearsome to infantry forces but a useful utility weapon on the battlefield. The *Hermes II*'s biggest advantage is the seven-and-a-half tons of Riese armor, more than any lighter unit scout unit. This allows the *Hermes II* to slug it out with lighter 'Mechs and survive a strike from a heavy unit so it can withdraw to fight another day. The famous "wings" on the heels of the 'Mech were originally designed to be heat sinks for the first prototypes but are vestigial as the designers moved the lone, non-engine heat sink to the left torso. Pilots have long been thankful for this, as it gives some protection to the vulnerable ammo bin.

Deployment

Found almost exclusively in the Free Worlds League, a few *Hermes IIs* have made their way out of the League either as battle salvage or with mercenary units. Irian prefers to sell 'Mechs in large lots, so the larger units in the League tend to get priority. Of course, Irian will make adjustments for smaller units desperate for the scout 'Mech—for a premium.

Variants

This solid design has had few variants. The most common one involves swapping out the weapons for a pair of large lasers; the HER-4K. This change is relatively easy as the twenty-eighth century prototype mounted a pair of advanced lasers and a flamer, though with superior heat sinks that could better handle the weapons' heat load. A more dramatic version, the HER-2M is nicknamed the *Mercury* [EDITOR'S NOTE: Not to be confused with the Hegemony design of the same name]. Powered by a larger VOX 280 fusion engine, the *Mercury* is faster, but the autocannon must be removed to offset the additional weight. Short-range firepower is improved with the addition of two more medium lasers and a pair of machine guns, but long-range firepower is severely curtailed. This version is found primarily in SAFE's Dark Shadows unit.

Notable MechWarriors

Force Commander Adam Spivey: Referred to as a "man with no soul" by his fellow warriors in the Dark Shadows, Spivey leads from the front and has earned his subordinate's loyalty. He has been labeled a troublemaker by some commanders, but those are often the ones who don't support their men. A rising star, Spivey made his name as a young lieutenant during the Fourth Succession War. As Tikonov Free Republic forces hit Wasat, the heavy Fifteenth Marik Militia was caught off guard. Colonel Jake Hawkins decided to establish an extremely static defense. Spivey's unit was placed on the east flank to cut off any scouts from running around the defense's end. Using superior mobility and tactics, his lance kept an entire heavy company busy while the middle of the Marik defensive line crumbled and Colonel Hawkins was captured.

MechWarrior Zane "The Dreamer" Ving: Some warriors are not cut out for leadership roles, and Ving is one of them. He is, however, an excellent scout pilot, and he even managed to take down a *Vindicator* as part of the Fourth Defenders of Andurien's advance into the Capellan Confederation during the Fourth Succession War. He doesn't follow any one particular faith, but rather absorbs philosophies and beliefs from many different sources. His 'Mech, "*Plato*," is covered in sayings and quotes from many different philosophers, from the revered Confucius to the controversial Aleksandr Kerensky and even including the despised Stefan Amaris.

HER-2S HERMES II

Type: **Hermes II**

Technology Base: Inner Sphere

Tonnage: 40

Battle Value: 784

Equipment

Internal Structure:

Engine: 240

Walking MP: 6

Running MP: 9

Jumping MP: 0

Heat Sinks: 10

Gyro: 3

Cockpit: 3

Armor Factor: 120

Mass

4

11.5

0

3

3

7.5

*Internal
Structure* *Armor
Value*

Head 3 9

Center Torso 12 17

Center Torso (rear) 6 6

R/L Torso 10 14

R/L Torso (rear) 5 5

R/L Arm 6 11

R/L Leg 10 14

Weapons

and Ammo

Location **Critical** **Tonnage**

Medium Laser RA 1 1

AC/5 RT 4 8

Ammo (AC) 20 LT 1 1

Flamer LA 1 1

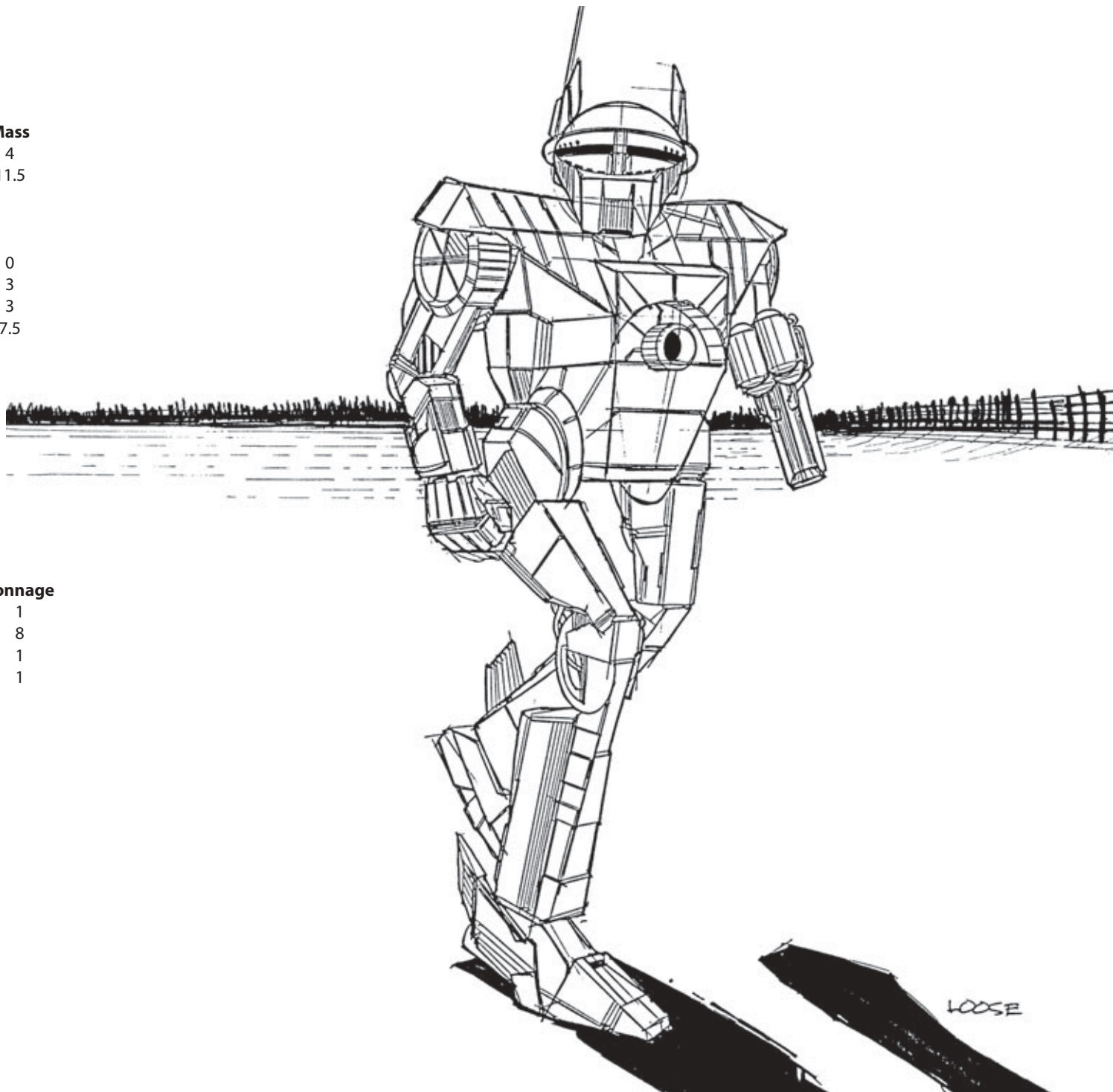

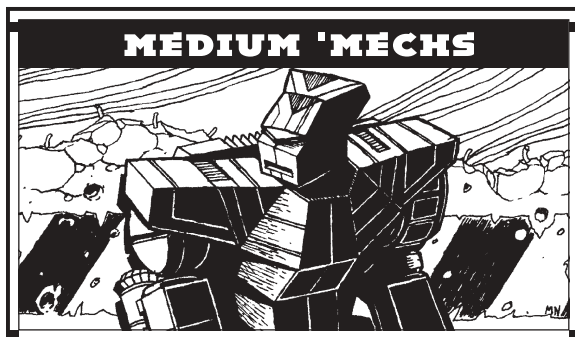

Mass: 40 tons
Chassis: Mather Tech 500
Power Plant: Pitban 240
Cruising Speed: 64 kph
Maximum Speed: 97 kph
Jump Jets: Model 9 Pitban
Jump Capacity: 180 meters

Armor: StarGuard I

Armament:

- 1 Armstrong Autocannon 2
- 1 Randell Medium Laser
- 1 Firestorm Flamer
- 1 SperryBrowning Machine Gun

Manufacturer: Nimakachi Fusion Products Ltd,
 Coventry Metal Works

Primary Factory: Tematagi (Nimakachi),
 Coventry (CMW)

Communications System: Hartford 200S

Targeting and Tracking System: Hartford TA10

Overview

As the Star League Defense Force drove into the Rim Worlds Republic-occupied Terran Hegemony, the need for an effective anti-infantry 'Mech was illustrated when many League 'Mechs were lost to Republic infantry. The bitter close-quarters fighting on the streets of the greatest cities of the Inner Sphere secured the *Vulcan's* birth.

When the MatherTechno Inc. production lines on Northwind were liberated by the advancing SLDF, General Aleksandr Kerensky had it converted to manufacture the new *Vulcan* anti-infantry BattleMech design. MatherTechno was destroyed within months of the fall of the Star League,

but the design specifications fell into the hands of the Lyran Commonwealth and Free Worlds League. The *Vulcan* remained in limited production throughout the Succession Wars.

Capabilities

The *Vulcan* is fully equipped with jump jets, giving it unparalleled mobility in its intended role as an urban fighter. The rear-mounted jets are specially vented to reduce heat build-up.

Weaponry includes a light but exceptionally reliable Armstrong autocannon. Initially intended for an anti-'Mech role, it more often sees service as an anti-building weapon. A medium laser serves as backup to the autocannon, but the *Vulcan's* primary weapons are the rapid-fire SperryBrowning machine gun and Firestorm flamer. Both weapons are guaranteed to send enemy infantry scurrying for safety.

The *Vulcan's* armor is not strong for a medium-class BattleMech but provides ample protection against small arms fire from the infantry it was designed to eradicate. In addition, the 'Mech presents a narrow silhouette that makes it a difficult target, and its profile earned the *Vulcan* the nickname of "Scarecrow."

The absence of manipulative hands is the 'Mech's only drawback. Though not a major hindrance, it limits its close combat capabilities against other 'Mechs.

Deployment

The *Vulcan* reached the front lines during General Kerensky's landings on Terra, where it served with the Volunteer Regiments and earned a reputation as a tough urban fighting machine. After the fall of the Star League, every major House secured a sizable number of *Vulcans*. With only the Lyran Commonwealth and Free Worlds League able to manufacture the design, the majority of operational *Vulcans* are now found in their forces.

House Davion used the *Vulcan* extensively to regain control of Kentares IV from House Kurita. *Vulcans* led the Davion counterattack in the cities of Amishton and Davisbury to flush out the Kuritan infantry. Though the 'Mechs' flamers devastated most of these depopulated metropolises, they successfully captured or killed the Kuritan garrisons in both cities.

House Liao deployed many of its *Vulcans* on the planet Sappho, and many were lost when the world fell to House

Marik during the First Succession War. As a result, House Liao has the fewest number of *Vulcans* in service of any of the Great Houses.

Variants

MatherTechno experimented with several variants. The most common is the VL-5T, which replaces the Armstrong autocannon with two tons of armor, two heat sinks, and three Maxum medium lasers. Many of the Federated Suns *Vulcans* are of this type.

Notable MechWarriors

MechWarrior Richard Timms: Richard Timms is the last heir of the famous Timms family. Suffering from Bethold Syndrome (an incurable disease), Timms had a handful of years left to live. He sold all the remaining family lands and used the money to maintain an extravagant lifestyle and to keep his *Vulcan* in perfect working condition. But when a copy of the Helm Memory Core reached the NAIS, everything changed for Timms. Among the first technological wonders recovered was a cure for Bethold Syndrome.

Given a new lease of life, Richard continues to serve in the Third Davion Guards and has secured his name under the flag of House Davion.

Leutnant Sonda Stoverston: Sonda commands a medium lance in Steiner's Twentieth Arcturan Guard, and is considered one of the best MechWarriors in the regiment. Her *Vulcan*, "*Bloodlust*," is painted a brownish-red and reflects her attitude toward combat. Sonda is a major threat to any infantry unit, with a reputation for killing platoons to the last person.

During the Fourth Succession War, Sonda participated in the fighting around Lake Noswe on Buckminster. The Mechanized infantry attached to the Sixth Arkab Legion broke and ran rather than face Sonda and her *Bloodlust*.

MechWarrior Wommel Hide: Wommel was assigned to the Fusiliers of Oriente. Drummed out for unknown reasons, he drifted into employment with the notorious Redjack Ryan. His 'Mech is in poor shape, but Hide is a competent MechWarrior who has honed his skills to fight against House Marik.

VL-2T VULCAN

Type: **Vulcan**

Technology Base: Inner Sphere

Tonnage: 40

Battle Value: 642

Equipment

Internal Structure:

Engine:

Walking MP:

Running MP:

Jumping MP:

Heat Sinks:

Gyro:

Cockpit:

Armor Factor:

Mass

4

11.5

240

6

9

6

10

0

3

3

5

*Internal
Structure*

*Armor
Value*

Head

3

8

Center Torso

12

10

Center Torso (rear)

6

R/L Torso

10

8

R/L Torso (rear)

4

R/L Arm

6

6

R/L Leg

10

10

Weapons

and Ammo

Location

Critical

Tonnage

AC/2

RT

1

6

Ammo (AC) 45

RT

1

1

Medium Laser

LT

1

1

Flamer

RA

1

1

Machine Gun

LA

1

.5

Ammo (MG) 200

LT

1

1

Jump Jets

CT

2

1

Jump Jets

RT

2

1

Jump Jets

LT

2

1

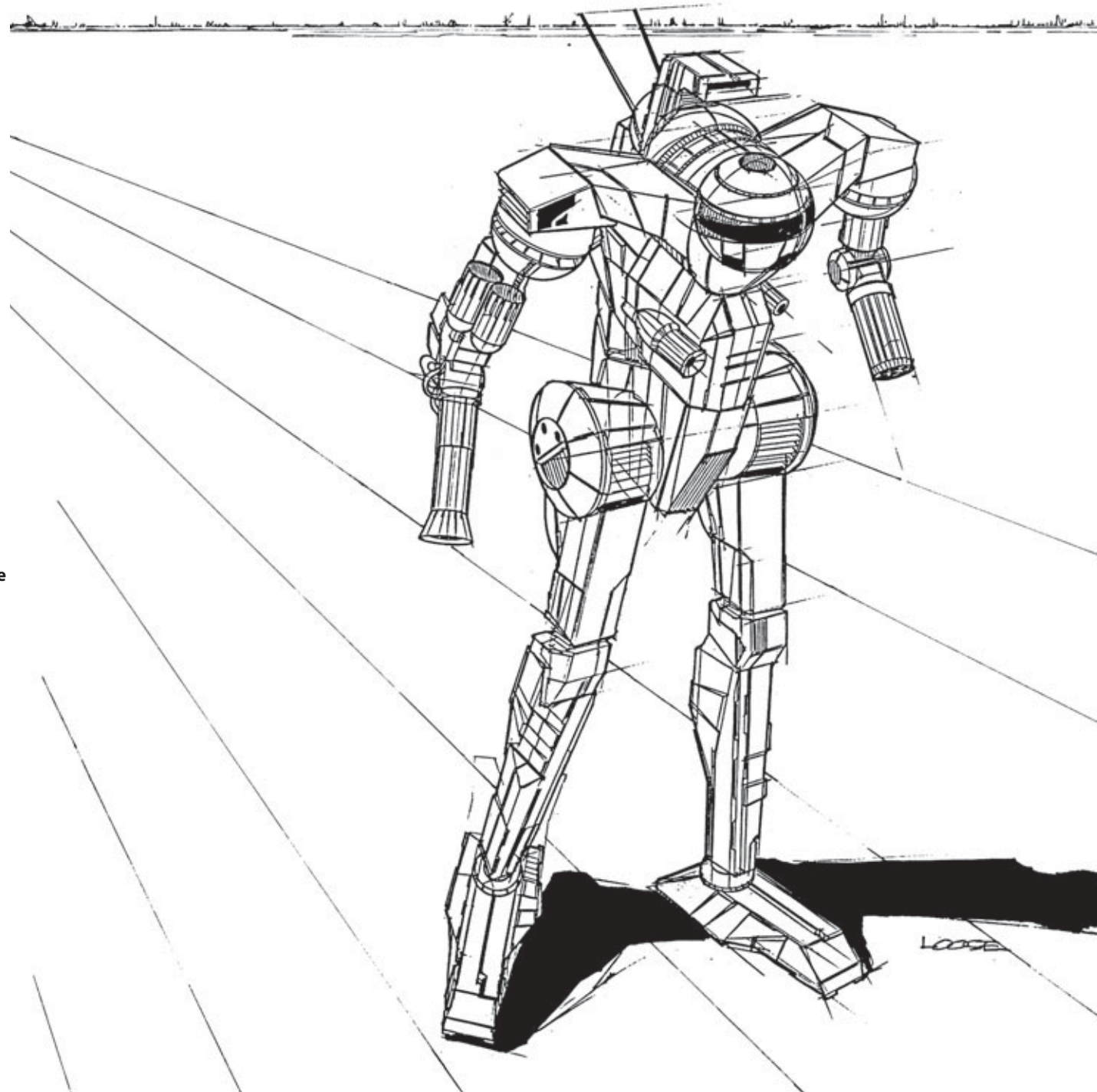

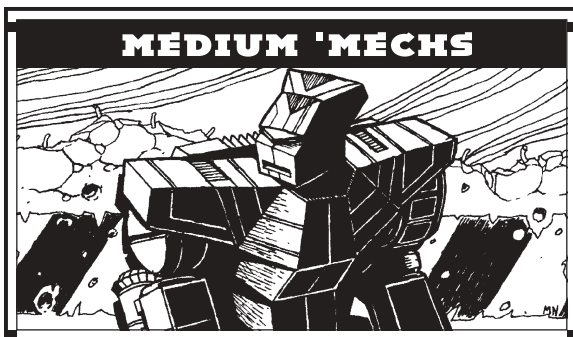

Mass: 40 tons
Chassis: Whitworth Type I
Power Plant: LTV 160
Cruising Speed: 43 kph
Maximum Speed: 64 kph
Jump Jets: Whitworth Jetlift
Jump Capacity: 120 meters
Armor: Durallex Light
Armament:
 2 Longbow-10 LRM Launchers
 3 Intek Medium Lasers
Manufacturer: Whitworth Company
Primary Factory: Dieron (destroyed 2776)
Communications System: Garret T14
Targeting and Tracking System: Garret D2j

Overview

The *Whitworth* was first built in 2610 as a scout 'Mech intended to fill the gap between the light *Wasp* and the medium *Phoenix Hawk* designs. What came out of the Whitworth Company's think tank was a mediocre design that, while decently armed, was slower than either the *Wasp* or *P-Hawk*. Adequately armored, the *Whitworth* had some staying power on the battlefield but could not hope to keep up with its lancemates in a running firefight.

Originally armed with dual Harpoon-6 SRM launchers, Star League designers convinced the manufacturer to switch to the longer reach of the Longbow LRM 10 series after noting that many *Whitworth* pilots would rush into close-range combat in order to effectively use its weapon

loadout (despite the fact that most pilots were Kuritan in origin and adhered to the *samurai*-style of fighting). Known among critics and admirers alike as the "Tin Woodsman," the *Whitworth* served the SLDF as a scout unit or a member of a mobile strike lance.

The Star League's death also brought the destruction of hundreds of *Whitworths*, since many were assigned to heavy combat zones. Though survivors were quickly recruited into the Great Houses' military machine, the destruction of so many factories indicated that the design was destined to fade away at some future point.

Capabilities

Handicapped at close range, the *Whitworth* receives excellent long-range abilities from its Longbow missile launchers. While its mass allows it to stand up in combat against units of equal and lesser size, the 'Mech is not designed as a brawler by any stretch of the imagination. Lacking hand actuators, crippled with a mediocre short-range weapon loadout, and not having the high speed curve of lighter 'Mechs, the *Whitworth* does not serve well as a short-range slugger, and pilots who try to use it as such often find themselves rocketing into the sky on their ejection seat. What's more, the design incorporates a faulty actuator system in the hips and legs (replacing the system isn't feasible, as it would require a complete reworking of the lower half of the torso and leg assembly), meaning that too many MechWarriors have found themselves sprawled on the battlefield and unable to move due to unresponsive (or even missing) legs.

Deployment

The original WTH-1S series was found throughout the Star League armies, often among heavily reinforced urban strike companies. Many Rim Worlds Republic armies employed *Whitworths* in a more brutish role, loading half of their SRM ammo bins with inferno rounds that were used to set entire cities aflame.

After the fall of the Star League, many *Whitworths* were absorbed into the Great Houses. With the massive destruction of the Whitworth Company's extensive complex on Dieron during the Amaris Crisis, these *Whitworths* were

used until they could no longer be repaired and then became "parts storage," as the actuator and structural mounts were adaptable to many medium 'Mech designs.

Less than three hundred *Whitworths* are estimated to be in operational condition, mostly in the hands of families and passed down through MechWarrior generations. Spare parts are hard to come by, though that began changing in 3035 as Whitworth Specialty Manufacturing became incorporated on Benjamin in the Draconis Combine and began manufacturing spare parts specific to the WTH-1 design. Rumors abounded that ComStar was influential in the company's startup and was somehow tied to the secret deal struck between that organization and Theodore Kurita in 3034.

Variants

Though the WTH-1 is the most common *Whitworth* design on the battlefield, there are two very rare variants.

The extremely rare WTH-1S mounted dual SRM 6 racks, which encouraged close-range combat in a design that wasn't armored or maneuverable enough for it. These were phased out and replaced with the LRM 10 racks as a field refit as the newer WTH-1 designs were produced.

The WTH-0 design was fielded exclusively by the Amaris Dragoons and used more as a terror weapon. Only twenty-four were ever made by Whitworth's Republic branch on some forgotten world. The main difference between the WTH-1S and the -0 was the replacement of the left arm laser with a Fleur-Static Flamer system. Painted matte black, these *Whitworths* became notorious for setting entire cities ablaze with their liberal and indiscriminate usage of their flamers and inferno-loaded SRM launchers.

Notable MechWarriors

Diablois Murta: With no known rank, Murta was the unofficial leader of the Ninth Company of the Ninety-ninth Amaris Dragoons. These twelve men were responsible for the systematic razing of nearly two dozen Lyran towns and cities along the Commonwealth-Republic border during the Lyran annexation of the Republic.

WTH-1 WHITWORTH

MEDIUM 'MECHS

127

Type: **Whitworth**

Technology Base: Inner Sphere

Tonnage: 40

Battle Value: 982

Equipment

		Mass
Internal Structure:		4
Engine:	160	6
Walking MP:	4	
Running MP:	6	
Jumping MP:	4	
Heat Sinks:	10	0
Gyro:		2
Cockpit:		3
Armor Factor:	128	8

	Internal Structure	Armor Value
Head	3	9
Center Torso	12	16
Center Torso (rear)		7
R/L Torso	10	12
R/L Torso (rear)		6
R/L Arm	6	12
R/L Leg	10	18

Weapons

and Ammo	Location	Critical	Tonnage
LRM 10	RT	2	5
Ammo (LRM) 12	RT	1	1
LRM 10	LT	2	5
Ammo (LRM) 12	LT	1	1
Medium Laser	H	1	1
Medium Laser	RA	1	1
Medium Laser	LA	1	1
Jump Jets	RL	2	1
Jump Jets	LL	2	1

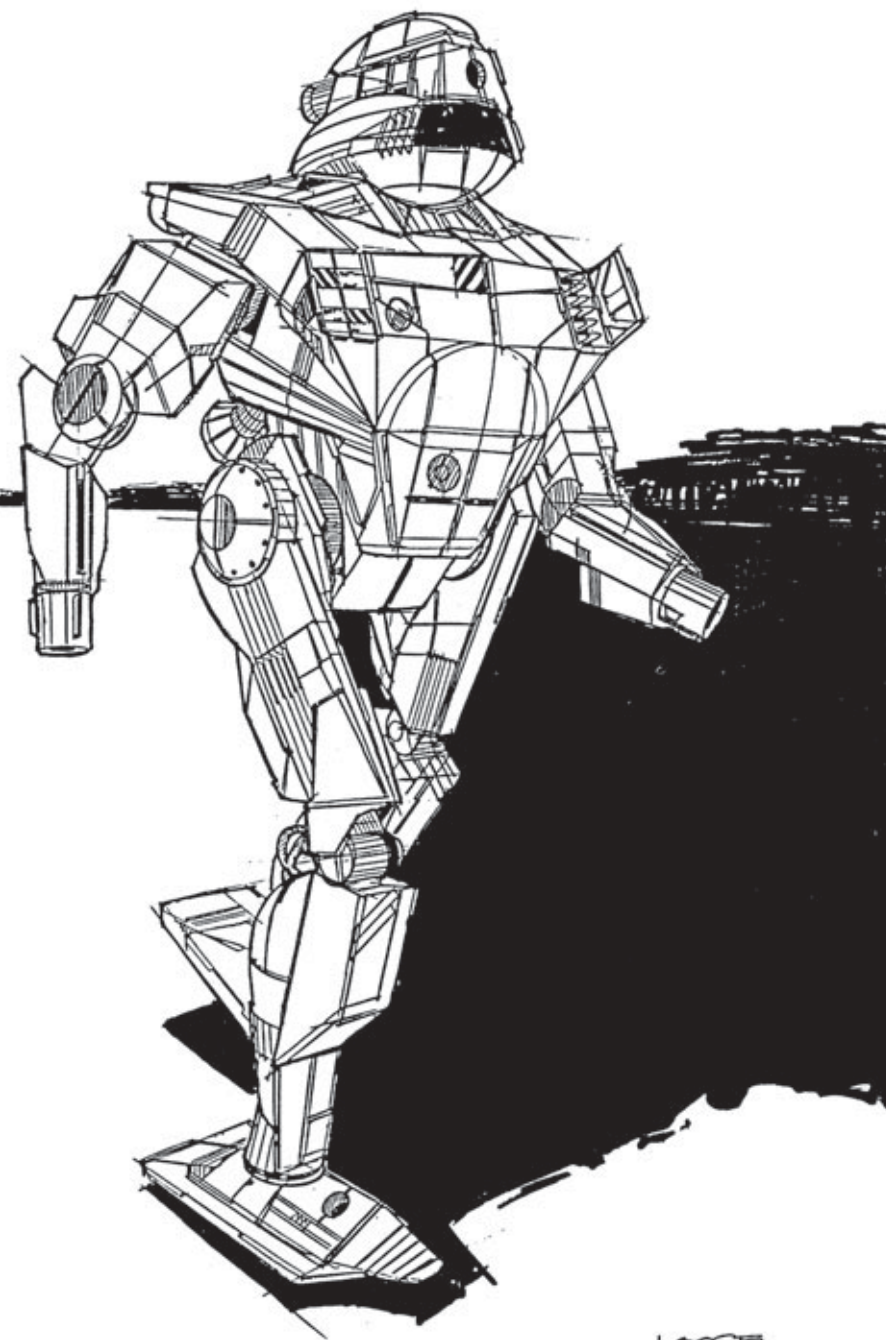

LOOSE

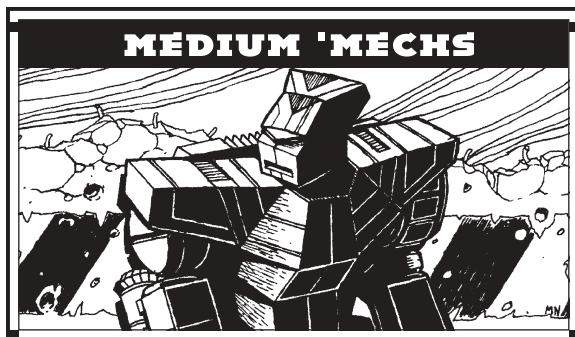

Mass: 45 tons
Chassis: GM BJ-1
Power Plant: GM 180
Cruising Speed: 43 kph
Maximum Speed: 64 kph
Jump Jets: Whitworth Jetlift
Jump Capacity: 120 meters
Armor: StarGuard II
Armament:
2 Whirlwind-L Autocannon
4 Intek Medium Lasers
Manufacturer: General Motors
Primary Factory: Kathil (destroyed 2796)
Communications System: Dalban Micronics
Targeting and Tracking System: Dalban AQ

Overview

General Motors' original contract with the SLDF called for "a medium BattleMech with insurgency suppression and fire-support capabilities." The result was the *Blackjack*. Despite fulfilling all its production requirements, the *Blackjack* unfairly developed a bad reputation and was rejected by the Star League.

Capabilities

The *Blackjack's* original role was to help suppress insurgent forces (mainly in the Periphery) that challenged Star League authority in the decades before its fall. In its secondary role as a fire support platform, the *Blackjack* is only a moderate success. The Whirlwind autocannon lacks the firepower to deal with well-armored targets. However,

the four Intek medium lasers pose a far greater threat at close range. Jump jets were added very late in the design process, but the Whitworth Jetlift units have proven to be an invaluable asset over the centuries.

The *Blackjack's* only real drawback was its bad press, which claimed that the entire project was a boondoggle because the 'Mech's basic design was flawed and unstable. It was often said that the 'Mech's narrow footpads led to falls and reduced its mobility, or that the StarGuard II armor was brittle and tended to fall off. Though none of these claims were ever substantiated, the *Blackjack* nevertheless fell into disfavor, and few mourned the loss of GM's production line.

Deployment

The *Blackjack* saw little service with the Star League, and production soon halted. Relegated to service with Hegemony planetary militia or sold off to League member states, the *Blackjack* can still be found on the battlefield today. The majority now serve with the Capellan Confederation and Federated Suns.

The Confederation has nothing short of contempt for the design. On the other hand, the breakaway St. Ives Compact could not be as choosy, and the *Blackjack* serves in the St. Ives Lancers.

The Federated Suns deployed the *Blackjack* in the March Militias until the myth of the *Blackjack's* inferiority received a blow in 3022 on Xhosa VII. Now the Crucis Lancers and Deneb Light Cavalry began taking a renewed interest in the 'Mech.

The infamous Kuritan Captain Mercer Ravannion attempted to use his "horde" tactics against the Davion garrison on the ice world of Xhosa VII. Cadet Captain Michael Ubodo's "outmoded and inferior" *Blackjacks* took the brunt of the Kuritan attack on the icy Plain of Swords. The fighting was fierce. Driven by fanaticism, Ravannion threw wave after wave of light 'Mechs into battle without regard for men or material.

Ubodo, a recent NAIS Training Cadre graduate brevetted to command of the Xhosa garrison, remained calm. Utilizing what little terrain there was, he shifted his forces to counter each Kuritan thrust. Then he personally led the counterattack that broke the back of Ravannion's assault.

Ravannion withdrew to "further refine his theories," and was killed a year later attempting to use his tactic against McKinnon's Raiders on Fallon II.

Hanse Davion personally decorated Ubodo. The sight of the much-maligned *Blackjack* standing in line for Davion honors alongside *Atlases* and *Victors* has forced some critics to reconsider their opinion of the 'Mech.

Variants

Early *Blackjack* prototypes differed from the production model significantly. Originally armed with twin GM Flashpoint flamers and additional heat sinks in place of each autocannon, it lacked jump jets but was powered by a VOX 225 power plant.

Hanse Davion was so impressed by the *Blackjack's* showing on Xhosa VII that he began experimenting with new versions. The first thing Davion engineers discovered was that the *Blackjack's* instability is a myth. The BJ-1DB replaces the autocannon with large lasers and adds six extra heat sinks. This necessitated the removal of the arm-mounted medium lasers and one ton of armor. The BJ-1DC replaces the jump jets with two torso-mounted small lasers and a heat sink.

In the 3030s, the St. Ives Compact experimented with recovered technology on some of their *Blackjacks*. One prototype that showed great promise replaced the autocannon and one heat sink with a pair of Ceres Arms Smasher PPCs. Three of the remaining heat sinks were replaced with experimental "freezer" double efficiency units.

Notable MechWarriors

Major Michael Ubodo: Best remembered for his actions in defense of Xhosa VII, Ubodo and his *Blackjack*, "*The Arrow*," was given a permanent commission in the Eighth Deneb Light Cavalry. Rising through the ranks to command, Michael has earned the respect of his troops with his easygoing but efficient style of command. Major Ubodo is a great proponent of the maligned *Blackjack*, and he challenges anyone who criticizes it. He is just as fiercely loyal to his men and to House Davion.

BJ-1 BLACKJACK

MEDIUM 'MECHS

129

Type: **Blackjack**

Technology Base: Inner Sphere

Tonnage: 45

Battle Value: 949

Equipment

		Mass
Internal Structure:		4.5
Engine:	180	7
Walking MP:	4	
Running MP:	6	
Jumping MP:	4	
Heat Sinks:	11	1
Gyro:		2
Cockpit:		3
Armor Factor:	136	8.5
	<i>Internal Structure</i>	<i>Armor Value</i>
Head	3	9
Center Torso	14	18
Center Torso (rear)		9
R/L Torso	11	15
R/L Torso (rear)		6
R/L Arm	7	12
R/L Leg	11	17

Weapons

Weapons and Ammo	Location	Critical	Tonnage
AC/2	RA	1	6
AC/2	LA	1	6
Ammo (AC) 45	CT	1	1
Medium Laser	RA	1	1
Medium Laser	RT	1	1
Medium Laser	LA	1	1
Medium Laser	LT	1	1
Jump Jets	RL	2	1
Jump Jets	LL	2	1

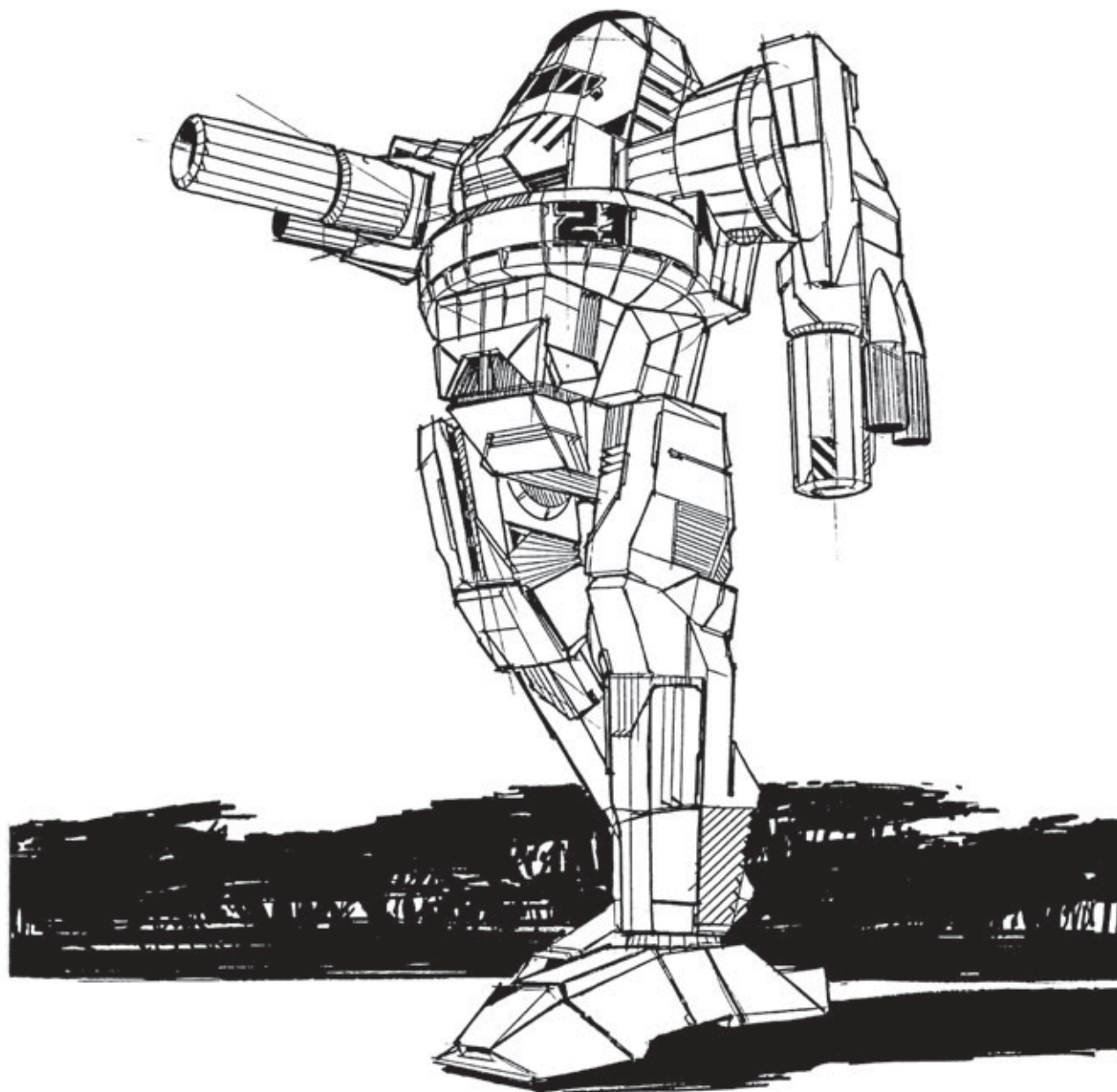

LOOSE

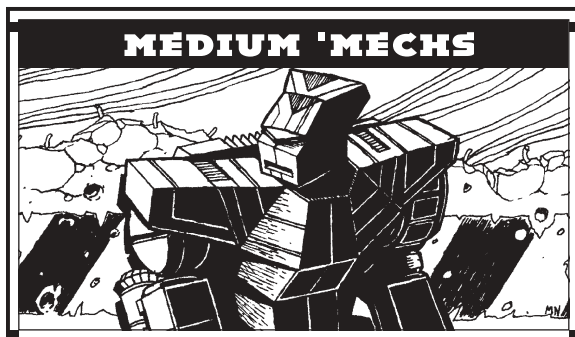

Mass: 45 tons

Chassis: Ceresplex IV

Power Plant: GM 180

Cruising Speed: 43 kph

Maximum Speed: 64 kph

Jump Jets: Anderson Propulsion 30

Jump Capacity: 120 meters

Armor: Starshield

Armament:

- 1 CeresArms Smashers PPC
- 1 Sian/Ceres Jaguar LRM Missile System
- 1 CeresArms Medium Laser
- 1 Hessen Small Laser

Manufacturer: Ceres Metals Industries

Primary Factory: Capella

Communications System: CeresCom Model 21-Rs

Targeting and Tracking System: C-Apple Churchill

Overview

After the First Succession War, the Capellan military needed 'Mechs badly. Ceres Metals took the challenge and provided a cheap but tough 'Mech that could be mass produced. Like the proverbial camel, the *Vindicator* is a committee-designed beast that fills many roles adequately but none of them well. It does, however, utilize the Confederation's resources well, being built with parts and weapons that can be manufactured in quantity.

Capabilities

The GM 180 engine at the heart of the *Vindicator* is unexceptional, but it is small and inexpensive, allowing it to be produced in large numbers while granting the

Vindicator a top speed over 60 kph. Four jump jets allow more maneuverability in confined areas, especially the many urban areas of the Confederation. The Starshield armor provides the *Vindicator* with more protection than can be found on any smaller 'Mech. Recent adjustments to the head-mounted laser, which intruded into the cockpit, have made the ejection system less likely to malfunction.

The primary weapon of the *Vindicator* is the Smasher PPC. A reliable weapon with an innovative cooling jacket, the PPC can be cooled with water drawn in through muzzle ports. However, the required kneeling posture leaves the *Vindicator* as a rather tempting, immobile target for long seconds. For additional long-range punch, an LRM 5 rack rests securely in the torso of the 'Mech. At closer ranges, a medium and small laser can be brought to bear. Critics complain that while the slow speed and jumping make the unit well suited to urban terrain, the inability of the missiles and PPC to target opponents at point blank range is a flaw. The *Vindicator* performs far better as a fire-support 'Mech for light units or as a shock trooper against smaller 'Mechs.

Deployment

The *Vindicator* is almost exclusive to the Capellan Confederation. A few have been captured as battle salvage, but the lackluster performance and the outrageous mark-up that Ceres puts on parts sold outside the Confederation makes it a pariah. Even mercenaries working for the Liao grudgingly accept it, knowing that if they want to keep their *Vindicators* working well they will have to continue to work for the Confederation or pay through the nose. *Vindicators* are the workhorse of the Confederation, and they can be found in every regiment and almost every role, from recon units to filling in force casualties in assault units.

Variants

The first *Vindicators* off the production line carried CeresArms machine guns in place of the Hessen laser. To stimulate domestic trade, the Confederation forced Ceres to purchase at least one non-proprietary weapon system, and Ceres chose the smallest one, the Hessen laser. A later attempt to improve speed and jump capability by sacrificing armor ended in failure. Speed is no substitute for armor on the modern battlefield. A few of the VND-1AA *Avenging Angel* variants were sent to the Free Rasalhague Republic as a "gift."

Notable MechWarriors

Major Choung Vong: Choung Vong is a hard woman to miss. Between her outspokenness and her 125 kg (at least) weight on a 1.85-meter frame, superiors and subordinates are always aware of Vong. While some accuse her of being a bully, the bottom line is that Major Vong gets things done. In the Fourth Succession War her company recorded more kills than any other Capellan company, though they did suffer nearly 75 percent casualties by war's end. Vong herself managed to destroy a Davion *Victor*, pummeling the cockpit to a pulp. She has had her *Vindicator* modified, moving the medium laser to the left arm in place of the small laser, allowing for a roomier cockpit.

Commander Chad Jackson: While a decent MechWarrior in House Imarra, Chad is most famous for posing for underwear advertisements. The warriors under his command grumbled that his looks have advanced him more than his leadership skills, his classic Chinese features being en vogue during Chancellor Romano's regime. While he tried to downplay this, it has been noted that the Chancellor had him over for "private visits" more frequently than even Master Rush in the early '30s.

MechWarrior Michael Jones: Now in the Second St. Ives Lancers, Michael was glad to escape the political nightmare that killed his father and nearly himself. Scheduled to be court-martialed when war broke out, he managed to escape this fate when his unit followed Candace Liao in succession. St. Ives has been more accommodating, going so far as to consider standardizing *Vindicators* based on Jones' field modification: an upgraded LRM system and a large laser to replace the PPC.

VND-1R VINDICATOR

MEDIUM 'MECHS

131

Type: **Vindicator**

Technology Base: Inner Sphere

Tonnage: 45

Battle Value: 1,024

Equipment

Internal Structure:

Engine: 180

Walking MP: 4

Running MP: 6

Jumping MP: 4

Heat Sinks: 16

Gyro: 2

Cockpit: 3

Armor Factor: 144

Internal Structure	Armor Value
--------------------	-------------

Head	3	9
------	---	---

Center Torso	14	18
--------------	----	----

Center Torso (rear)		9
---------------------	--	---

R/L Torso	11	16
-----------	----	----

R/L Torso (rear)		6
------------------	--	---

R/L Arm	7	14
---------	---	----

R/L Leg	11	18
---------	----	----

Mass

4.5

7

6

2

3

9

Weapons

and Ammo

	Location	Critical	Tonnage
PPC	RA	3	7
Medium Laser	H	1	1
Small Laser	LA	1	.5
LRM 5	LT	1	2
Ammo (LRM) 24	LT	1	1
Jump Jet	RL	1	.5
Jump Jets	CT	2	1
Jump Jet	LL	1	.5

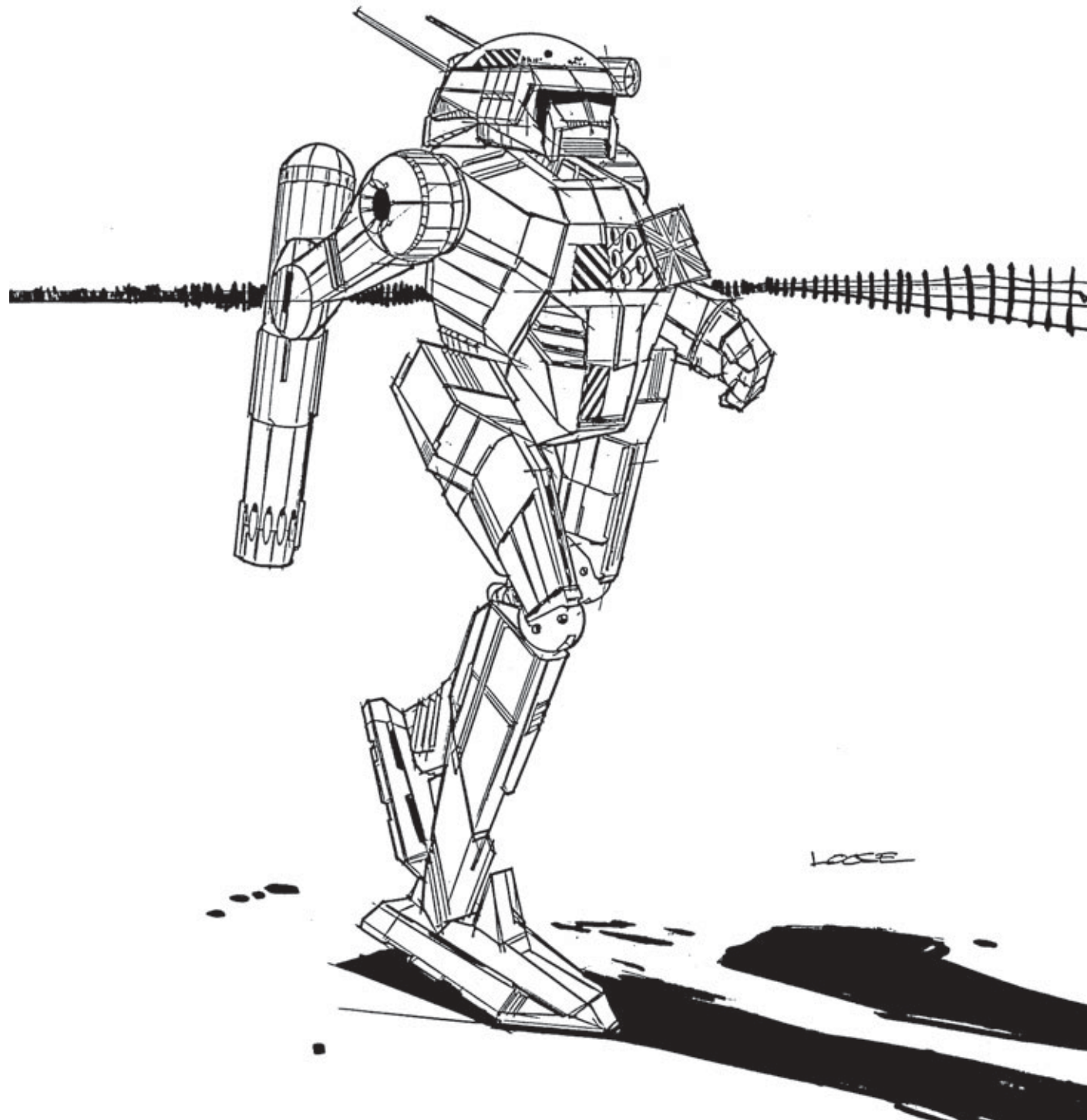

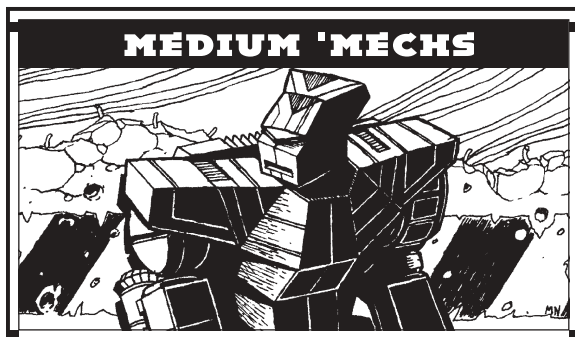

Mass: 50 tons

Chassis: Corean Model K7

Power Plant: Nissan 200

Cruising Speed: 43 kph

Maximum Speed: 64 kph

Jump Jets: None

Jump Capacity: None

Armor: StarGuard III

Armament:

1 Luxor D-Series Autocannon

1 Luxor 3R LRM 10

2 Photech 806c Medium Lasers

Manufacturer: Corean Enterprises

Primary Factory: New Avalon

Communications System: Corean Transband-J9

Targeting and Tracking System: Corean B-Tech

Overview

The *Centurion* was designed and built by Corean Enterprises as an operating partner for the successful *Trebuchet*. Produced initially from 2801 until the main plant on Ramen II was destroyed in 2845, the *Centurion's* weapons revolve around the arm-mounted Luxor medium-heavy autocannon. Coupled with a Luxor LRM 10 and split-arc medium lasers, the *Centurion* represents a well-rounded combat platform at 50 tons.

Buoyed by the initial success and warm reception of the design by AFFS forces, Corean built a secondary manufacturing facility on New Avalon in 3012 after supplying a steady stream of spare parts to AFFS line units for nearly 150 years. Corean Enterprises also relocated their entire headquarters to New Avalon.

Capabilities

The CN9-A is best known for making slow, steady advances. Its autocannon and medium lasers allow the 'Mech to inflict maximum damage when attacking at close range, and with eight-and-a-half tons of armor, the *Centurion* is tough enough to absorb a considerable amount of punishment. The downside of the *Centurion* is well known in technical circles. With a series of defects in the autocannon loading system, the CN9-A is notorious for having an extremely difficult repair rate when the Luxor autocannon or ammo feed system is involved. Attempts to replace the Luxor system with a different model have met with mixed results, most often ending in failure. The replacement process was extremely time-consuming and with such a low success rate that the AFFS considered phasing the 'Mech from its inventory in the early 3000s for the more durable *Enforcer*. Corean managed to convince AFFS officials not to do so and spent billions of D-bills annually in researching various upgrades and platforms—including experimental weapon systems—to fix the *Centurion's* chronic problem. The NAIS, noting Corean's continued efforts, signed a partnership deal with the company in 3022 to supply the Federated Sun's most distinguished research lab with a steady supply of test-bed *Centurions*.

Needless to say, the AFFS reconsidered their plans for a phase-out and kept the 'Mech as a centerpiece in its medium 'Mech companies. The twenty reloads for the autocannon and twenty-four rounds for the LRM launcher allow it to operate for a short time from a supply base. With the added ability to move quickly and fire without overheating, the *Centurion* is ideal for AFFS raiding lances.

Deployment

The *Centurion* is considered the unofficial 'Mech of House Davion's BattleMech forces by most of Davion's enemies. The formidable appearance of the *Centurion's* autocannon tends to elevate the pilot's confidence and give him the feeling he can blast his way through anything. This fighting spirit can often be a valuable psychological advantage to a lance or company facing stiff opposition.

Most *Centurions* found within Combine and Capellan forces are usually battlefield salvage from encounters with AFFS forces. These 'Mechs are often in some state of disrepair, considering Corean's inability to adequately supply rival Houses with repair parts at decent cost.

Variants

The most radical variant eliminates both medium lasers and the troublesome Luxor cannon and replaces them with a Luxor DDX-5 heavy autocannon. This design, known as the CN9-AH, is capable of eviscerating opponents at close range.

Another common variant is the CN9-AL, which replaces the autocannon with large and small Angst lasers, six additional heat sinks, and an extra two-and-a-half tons of armor.

Quite the favorite among the Solaris VII crowd after Justin Xiang Allard won the Grand Championship in 3027 was his unique CN9-YLW *Centurion* "*Yen-Lo-Wang*," which mounts a custom-fit Pontiac 100 AC/20 in place of the Luxor autocannon and LRM launcher. An improvised melee weapon in the form of a set of titanium nails on the left hand rounds out this deadly infighter.

Notable MechWarrior

Justin Xiang Allard: Architect and executor of one of the most successful espionage plots of the 31st Century, Justin Allard was considered a rising star among the AFFS and a close friend of Hanse Davion. Through a series of carefully orchestrated events, he managed to infiltrate the highest levels of the Capellan Confederation's Maskirovka and crippled the entire Capellan nation so the AFFS could bring half the stellar nation into the Davion fold. He also managed to woo the Chancellor's daughter Candace and extract her from Sian (with help from Morgan Hasek-Davion), which later led to the formation of the St. Ives Compact. Xiang Allard was subsequently installed as the Federated Suns' chief of intelligence. His exploits can be followed in an extremely popular trivid trilogy in the AFFS called *The Warrior: En Garde, Riposte, & Coupè*.

CN9-A CENTURION

MEDIUM 'MECHS

133

Type: **Centurion**

Technology Base: Inner Sphere

Tonnage: 50

Battle Value: 945

Equipment

Internal Structure:

Engine: 200

Walking MP: 4

Running MP: 6

Jumping MP: 0

Heat Sinks: 10

Gyro:

Cockpit:

Armor Factor: 136

Mass

5

8.5

0

2

3

8.5

*Internal
Structure*

*Armor
Value*

Head 3 9

Center Torso 16 18

Center Torso (rear) 7

R/L Torso 12 13

R/L Torso (rear) 6

R/L Arm 8 16

R/L Leg 12 16

Weapons

and Ammo

Location Critical Tonnage

AC/10 RA 7 12

Ammo (AC) 20 RT 2 2

LRM 10 LT 2 5

Ammo (LRM) 24 LT 2 2

Medium Laser CT 1 1

Medium Laser CT (R) 1 1

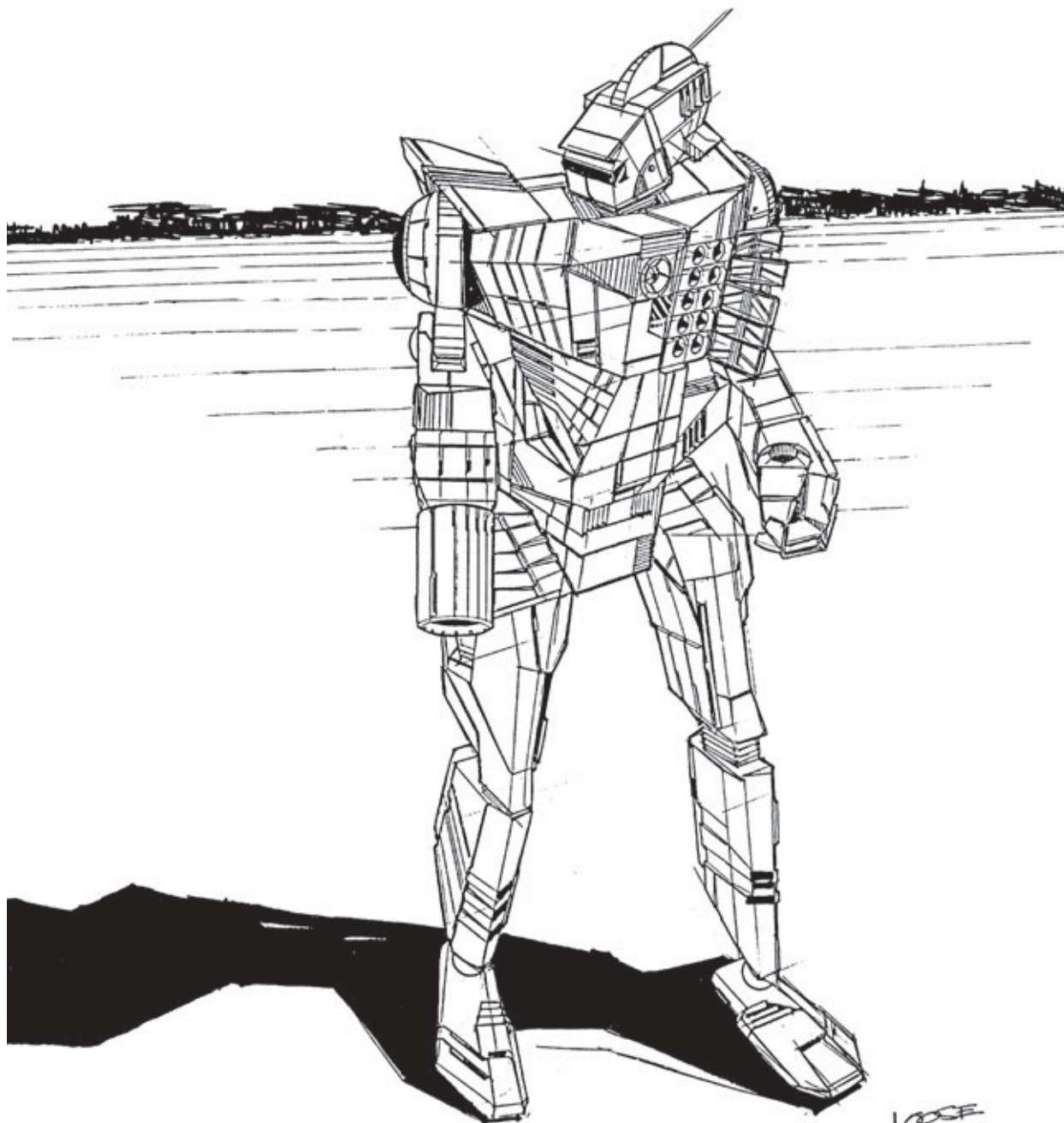

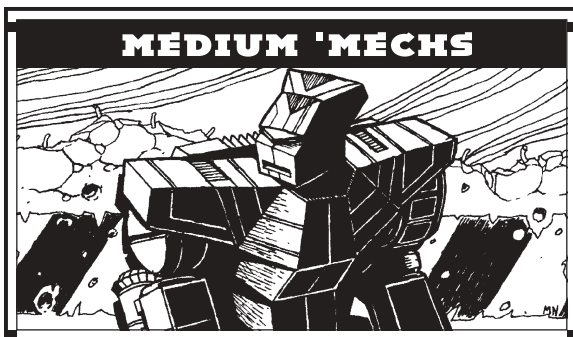

Mass: 50 tons
Chassis: Dorwinion Standard
Power Plant: Nissan 200
Cruising Speed: 43 kph
Maximum Speed: 64 kph
Jump Jets: McCloud Specials
Jump Capacity: 120 meters
Armor: Starshield
Armament:
 1 Federated Autocannon
 1 ChisComp 43 Special Large Laser
 1 ChisComp 32 Small Laser
Manufacturer: Achernar BattleMechs
Primary Factory: New Avalon
Communications System: Achernar Electronics
 HICS-11
Targeting and Tracking System: Federated Hunter

Overview

With the Star League destabilizing, First Prince John Davion was building up his forces. The Federated Suns was in the midst of its love affair with the autocannon, so when Achernar BattleMechs technicians stumbled over forgotten blueprints for an unbuilt autocannon-armed BattleMech, they used it as the basis for a new design.

The new *Enforcer* was rushed through development and was commissioned in 2777, and over the course of the Succession Wars the *Enforcer* became the workhorse of House Davion. During the press of the Clan invasion, the design was also licensed to Kallon Industries to expand production.

Capabilities

The original plans called for two medium lasers on the left arm, but Achernar engineers discovered that the 'Mech was structurally strong enough to handle a large laser instead. Matching the range of the class-10 autocannon, this combination of weapons allows the *Enforcer* to act as a mobile barrage vehicle. In this combat role, it lays down a fast and withering pattern of fire, either as a prelude to an offensive or to blunt an approaching enemy's attack.

As good as the autocannon is, the *Enforcer's* one major flaw is that it can carry only ten ammo rounds. To address this problem, *Enforcers* use ten-round clips that are easily slipped into and out of the 'Mech's back. If possible, a truck and crane system are parked close to *Enforcers* during battle to allow quick reloading of the 'Mech's autocannon. If the battle is too mobile and the *Enforcer* has no opportunities to reload, its pilot has no option but to ration his ten shots carefully.

The *Enforcer* serves the AFFS as a trooper 'Mech. Though it has no hands, the 'Mech is a good brawler with thick frontal armor and jump capability. In the hands of a good MechWarrior, the *Enforcer* can stand up well against almost all other 'Mechs in one-on-one combat. Only those 'Mechs whose armor can withstand more than two or three autocannon or laser hits are too tough for the *Enforcer* to handle alone. The *Enforcer* is also an excellent city sniper. If its pilot is familiar with the city, he can hit and run many times, returning to base to be reloaded while the enemy force flounders about looking for him.

What the *Enforcer* cannot take are attacks to its rear torso, where its armor is weaker than that of even some light 'Mechs.

Deployment

One of the few BattleMech designs that the Federated Suns can still manufacture in quantity, *Enforcers* are found in almost every BattleMech battalion.

During the offensive on Capra in the First Succession War, the *Enforcers* of the Second Crucis Lancers are credited with laying down such a concentrated barrage of autocannon fire that the opposing forces withdrew before the *Enforcers* had finished. A minor legend grew up around

that engagement. Lieutenant Cyril Sombelbime, commander of an all-*Enforcer* lance, was heard exhorting his group to fire "until your cannon glows. If need be, until it explodes!" According to the story, the lieutenant's autocannon did indeed start to glow, and its eventual explosion killed the prophetic officer.

Variants

Engineers have been attempting to up the number of shells the 'Mech can carry. Efforts are currently underway to rebuild the *Enforcer's* entire torso using recovered Star League technology.

Notable MechWarriors

MechWarrior Colin McBurnham: Of proud Scottish descent, Colin is well known for cursing in Gaelic during the heat of battle. His 'Mech, the "*Bannockburn*," is painted in his family's dark green, brown, and blue kilt colors. Its unmistakable appearance sometimes so intimidates McBurnham's foes that he can make an easy kill. Colin's specialty is city fighting. He loves the tense anticipation of waiting for an opponent to blunder into his gunsight.

MechWarrior Sarah Neelson: Tall and beautiful, Sarah has earned a reputation as a fearless fighter who will stand up and face withering enemy fire without the least hesitation. In turn, her aim is deadly. As a member of the Davion Heavy Guards, she has had plenty of chances to demonstrate her devil's eye.

MechWarrior Daniel Waylen: A graduate of the New Avalon Military Academy, Waylen is notable both for the number of black marks he earned while attending NAMA and for landing an assignment in the elite McKinnon's Raiders just before the Fourth Succession War.

Now a seasoned veteran, Daniel Waylen and his *Enforcer* have been selected to test an experimental NAIS Gauss rifle. The weight of the autocannon's replacement prompted the NAIS engineers to adopt the design's original twin medium-laser armament.

ENF-4R ENFORCER

Type: **Enforcer**

Technology Base: Inner Sphere

Tonnage: 50

Battle Value: 1,032

Equipment

Internal Structure:

Engine: 200

Walking MP: 4

Running MP: 6

Jumping MP: 4

Heat Sinks: 12

Gyro: 2

Cockpit: 3

Armor Factor: 144

Mass

5

8.5

2

2

3

9

	Internal Structure	Armor Value
--	--------------------	-------------

Head	3	9
------	---	---

Center Torso	16	23
--------------	----	----

Center Torso (rear)		4
---------------------	--	---

R/L Torso	12	17
-----------	----	----

R/L Torso (rear)		3
------------------	--	---

R/L Arm	8	14
---------	---	----

R/L Leg	12	20
---------	----	----

Weapons

and Ammo

	Location	Critical	Tonnage
--	----------	----------	---------

AC/10	RA	4	12
-------	----	---	----

Ammo (AC) 10	RT	1	1
--------------	----	---	---

Large Laser	LA	2	5
-------------	----	---	---

Small Laser	LT	1	.5
-------------	----	---	----

Jump Jets	RL	2	1
-----------	----	---	---

Jump Jets	LL	2	1
-----------	----	---	---

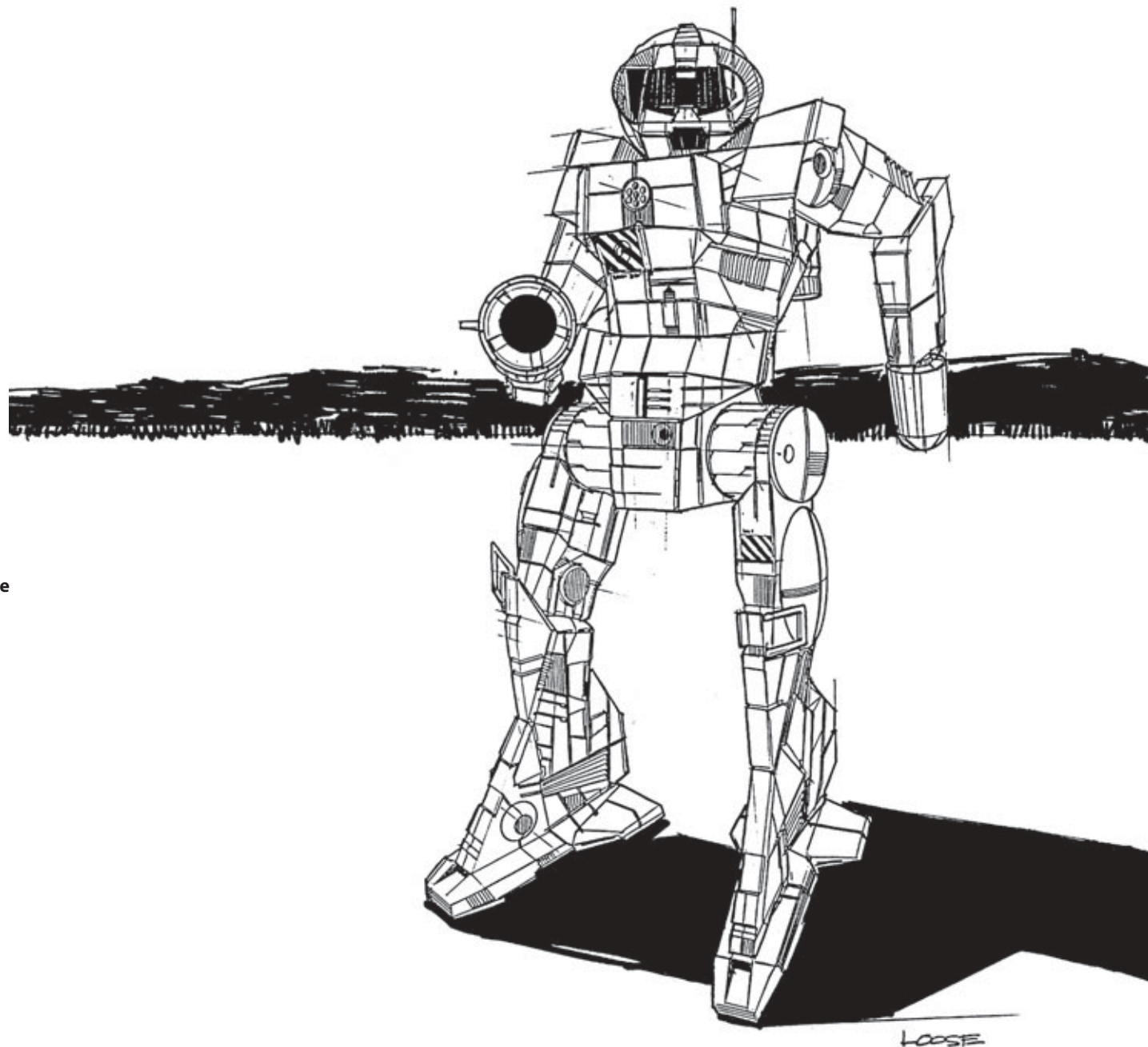

LOOSE

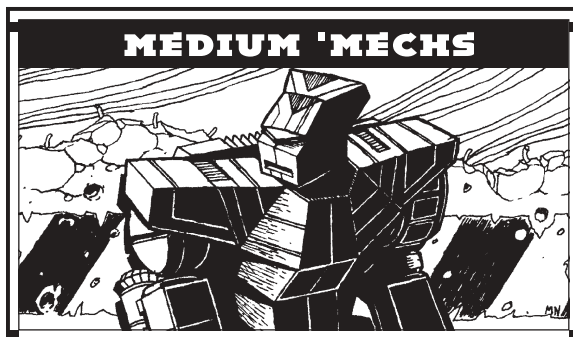

Mass: 50 tons

Chassis: Crucis Type V

Power Plant: Nissan 200

Cruising Speed: 43 kph

Maximum Speed: 64 kph

Jump Jets: None

Jump Capacity: None

Armor: Starshield

Armament:

1 Kali Yama Big Bore Autocannon/20

2 Hellion-V Medium Lasers

1 Diverse Optics Type 10 Small Laser

Manufacturer: KaliYama Weapons Industries

Primary Factory: Kalidasa

Communications System: Omicron 4002

Networking Channel

Targeting and Tracking System: TRSS Eagle Eye

Overview

An earlier design introduced in 2572, the *Hunchback* is a medium- to short-range brawler that rose to prominence during the many urban battles of the Reunification War. Widely known for its street-fighting abilities, the *Hunchback* soon earned the respect and admiration of many MechWarriors.

Though the original Komiyaba/Nissan General Industries factories were destroyed during the Succession Wars, Kali Yama acquired the rights to the design and was soon producing the *Hunchback* for the Free Worlds League

Capabilities

The AC/20 that takes up nearly a third of the design's mass exclusively defines the *Hunchback*. Able to strip armor and breach to internals in a single shot, the Kali Yama Big Bore is highly feared even among MechWarriors piloting assault-class 'Mechs. A pair of arm-mounted medium lasers and a single small laser rounds out the medium- and short-range array. Though the weapons are potent, when fired together the design will run moderately hot despite its thirteen heat sinks.

Though its ten tons of Starshield armor are comparable to many heavy designs, in actual practice the armor has been shown to be too light for the intense conditions many MechWarriors subject it to. With so few secondary systems, once the armor is breached the MechWarrior will often take a direct hit on their autocannon or, worse, their ammunition.

Too slow to keep up with most advanced elements of a fighting force, a *Hunchback* often finds itself as part of the second wave, using its fearsome main gun to exploit the weakened armor of an enemy. Often a defender will feel they have the battle won, only to have their morale plummet upon seeing a new *Hunchback* wading into the mix, dropping BattleMechs with one or two salvos.

Deployment

As an older design, the *Hunchback* is found in the armies of every Great House and Periphery nation. The design is particularly favored by the Draconis Combine and Capellan Confederation as it fits the preferred dueling nature and all-or-nothing tactics used by these states. With the only *Hunchback* factory situated in Marik space, the 'Mech is also used extensively by the forces of the Free Worlds League.

During the campaign for Elidere IV in the War of 3039, the Ninth Ghost Regiment was able to jury-rig two of their *Hunchbacks* with prototype Gauss rifles. Their initial use took the Screaming Eagle mercenaries by complete surprise, as they could not understand why they were taking such heavy damage at such long range. After losing almost half his command in less than half an hour, Colonel Hokala signaled his willingness to surrender and withdraw. Since

the Ninth's techs were unable to resolve the balance issues of the new weapon—the 'Mechs would often stumble and even fall when the Gauss rifles were fired—the original AC/20s were reinstalled following the end of the war.

Variants

Dwindling supplies and personal preference lead to the creation of many variants dubbed "Swaybacks." All strip out the massive autocannon for smaller and more numerous weapons, the most popular being banks of medium lasers (the HBK-4P) or short-range missile racks (the 4SP). Others, like the 4H and 4N designs, use smaller-grade autocannons and additional medium lasers, and some (such as the 4J) even turn their Swaybacks into fire-support designs with long-range missiles.

Notable MechWarriors

Busosenshi Sandy "Turtle" Porter: Piloting one of the two modified *Hunchback* chassis utilized by the Ninth Ghosts, Porter became known for her 'Mech spending more time on its back than standing during battle. Things became so bad that Porter had the Ninth's techs redistribute her 'Mech's armor to strengthen the rear torso. She would also prop her machine against buildings and large trees when firing, though it seemed to only break the trees and destroy buildings. Despite these problems, *Busosenshi* Porter enjoyed the modification to her machine (nicknamed "*Five Chances*") and was saddened by the order to change it back to its original configuration.

MechWarrior Michael Gai: Piloting a *Hunchback* captured during a raid into Marik space, Michael was a Dispossessed MechWarrior for three years prior until his infantry platoon went along with the Lyrans' BattleMech force. A game of "Rock, Paper, Scissors" with another dispossessed MechWarrior won the machine, which Michael named "*Never Again*." Michael has stated that despite once piloting a much heavier *Victor*, "the tactics are the same; get close, aim for the center mass and hold down the firing button till he drops or you do," a belief that his comrades say led to him becoming Dispossessed in the first place.

HBK-4G HUNCHBACK

MEDIUM 'MECHS

137

Type: **Hunchback**

Technology Base: Inner Sphere

Tonnage: 50

Battle Value: 1,037

Equipment

Internal Structure:

Engine:

Walking MP:

Running MP:

Jumping MP:

Heat Sinks:

Gyro:

Cockpit:

Armor Factor:

Mass

5

8.5

200

4

6

0

13

3

2

3

10

*Internal
Structure*

*Armor
Value*

Head

3

9

Center Torso

16

26

Center Torso (rear)

5

R/L Torso

12

20

R/L Torso (rear)

4

R/L Arm

8

16

R/L Leg

12

20

Weapons

and Ammo

Location

Critical

Tonnage

AC/20

RT

10

14

Ammo (AC) 10

LT

2

2

Medium Laser

RA

1

1

Medium Laser

LA

1

1

Small Laser

H

1

.5

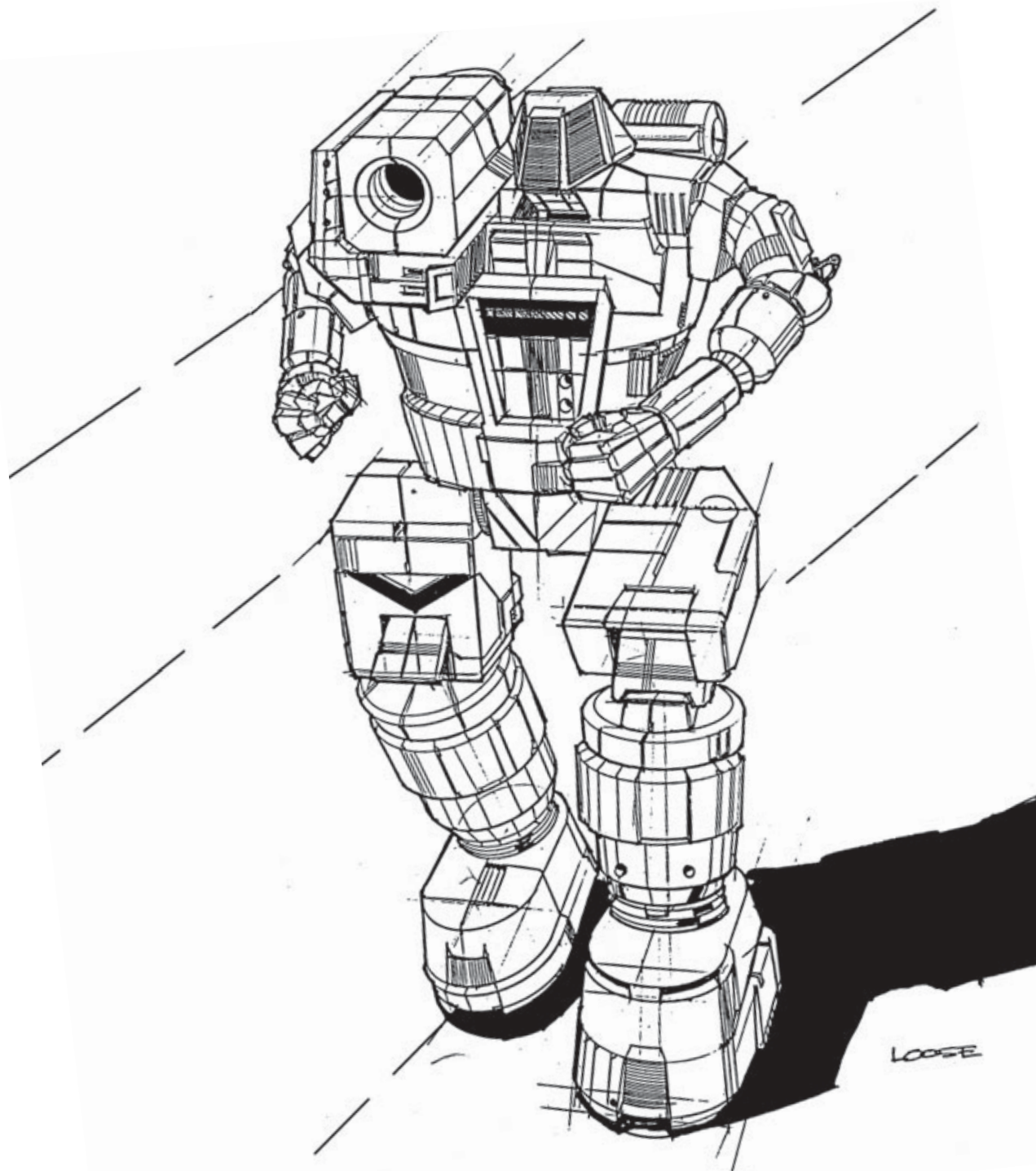

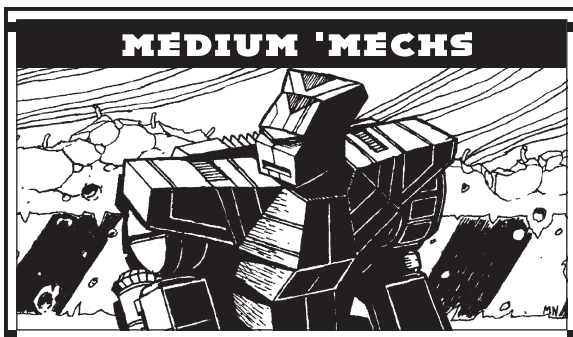

Mass: 50 tons

Chassis: Corean Model 9C

Power Plant: Magna 250

Cruising Speed: 54 kph

Maximum Speed: 86 kph

Jump Jets: None

Jump Capacity: None

Armor: Starshield

Armament:

2 Zeus LRM 15

3 Magna Mark II Medium Lasers

Manufacturer: Corean Enterprises,
Kali Yama Weapons Industries

Primary Factory: Stewart (Corean),
Kalidasa (Kali Yama)

Communications System: Corean TransBand-J9

Targeting and Tracking System: Corean B-Tech

Overview

Though carrying a blistering array of advanced technology due to its last-minute entry into the Star League Defense Force ranks in 2780, the *Trebuchet* was also one of the first BattleMechs that went back to the drawing board and was re-designed using older technology so Corean Enterprises could continue to manufacture the design through the Succession Wars, though the customer was now the Free Worlds League military.

Capabilities

One of the few pre-Clan Invasion designs made to work in a group rather than as a standalone BattleMech, designers hoped to make the *Trebuchet* a fine blend of

long-range and close-in fire support. Designers could not maximize both roles, but when used in a group, the design is exceptional for its size. Two Zeus LRM racks are the primary weapon of the 50-ton 'Mech. For close-in support, three medium lasers were deemed acceptable during the Succession Wars redesign, though it has been admitted the *Trebuchet* is outgunned up close by many other 'Mechs when fighting independently.

The biggest flaw in the *Trebuchet* is its lack of endurance. Though its lasers preclude any need for resupply when fighting at short range, its LRM racks only have enough ammunition for a little over a minute of continuous fire.

Deployment

House Marik is perhaps the largest user of the *Trebuchet*, thanks to its possession of Corean's and Kali Yama's facilities. At the end of the Third Succession War, the FWLM favored partnering the *Trebuchet* with the similarly armed *Archer*. And within a decade of 3039, *Trebuchet* refit and repair facilities, such as those owned by Irian, were upgraded by recovered technology to full production lines.

Variants

Two major variants have surfaced across the Inner Sphere and periphery nations. The 5J, initially developed by the Free Worlds League for more mobile regiments, replaces the arm-mounted LRM rack with a pair of extra heat sinks and enough jump jets for a 150-meter jump capacity. Though lacking raw firepower, its ability to maneuver in hard terrain surprised the Confederation's Chesterton Reserves when it first appeared.

The second variant is a close-combat unit, replacing the LRMs with a pair of Thunderstoke SRM 6 packs mounted in the same locations. The addition of eight extra heat sinks helps this 5S model stay cool in heavy combat, but like most short-range brawlers, the 5S requires cover when closing with its victims. The FWLM paired the 5Ss with 5Ns in the late 3030s, allowing one to provide cover fire while the other closes to finish the job. These pairings have been so successful that military planners in the League have begun looking into ways to expand this practice to other units (or perhaps to new BattleMech designs) to be paired up in complementary ways.

Notable MechWarriors

Busosenshi Sharron Burgoz: Assigned to the Sorenson's Sabres as an ISF informant, Burgoz eventually grew closer to her unit than handlers anticipated. Her custom 5K *Trebuchet* (nicknamed "*Snowball*") was a special variant undergoing testing by the DCMS. This version was an attempt to see if direct weapons fire-support could be a viable alternative to the more traditional indirect missile support in the long term, both in combat and logistically, by replacing the conventional *Trebuchet* weaponry with an autocannon, particle projection cannon, and a single SRM 2 pack. The outcome of the experiment is unknown; the proliferation of new technology in the following decades so radically shook up the Combine's design bureaus that sensible, simple experiments like this were lost in the chaos.

Lieutenant Morgana Kirkpatrick: A support lance commander in a minor mercenary command known as Kirkpatrick's Bandit Killers, Lieutenant Kirkpatrick is a raven-haired Canopian native whose maiden name (LaFayre) and penchant for wearing black leather off-duty attire have earned her the nickname "the Witch" amongst her comrades. Yet the wife of the Bandit Killers' commander, James Kirkpatrick (and mother of the couple's only child), ranks among one of the most cool and collected warriors in the battalion. Her ancient, battle-worn *Trebuchet* was often seen holding the rear line of Bandit Killers' battle formations, providing a constant rain of cover fire alongside her heavier lancemates (including a *Quickdraw* and a *Stalker*) while fending off anything fast enough to breach the front lines to engage them directly. During a foray on the world of Andiron for House Steiner, the Witch and her *Trebuchet* "*Rain Maker*" accounted for three Circinian bandit kills, including a vintage *Hussar* whose origins remain a mystery.

TBT-5N TREBUCHET

Type: **Trebuchet**

Technology Base: Inner Sphere

Tonnage: 50

Battle Value: 1,191

Equipment

		Mass
Internal Structure:		5
Engine:	250	12.5
Walking MP:	5	
Running MP:	8	
Jumping MP:	0	
Heat Sinks:	10	0
Gyro:		3
Cockpit:		3
Armor Factor:	120	7.5

	Internal Structure	Armor Value
Head	3	9
Center Torso	16	22
Center Torso (rear)		7
R/L Torso	12	11
R/L Torso (rear)		5
R/L Arm	8	10
R/L Leg	12	15

Weapons and Ammo

	Location	Critical	Tonnage
LRM 15	RT	3	7
Ammo (LRM) 8	RT	1	1
LRM 15	LA	3	7
Ammo (LRM) 8	LT	1	1
2 Medium Lasers	RA	1	1
Medium Laser	LA	1	1

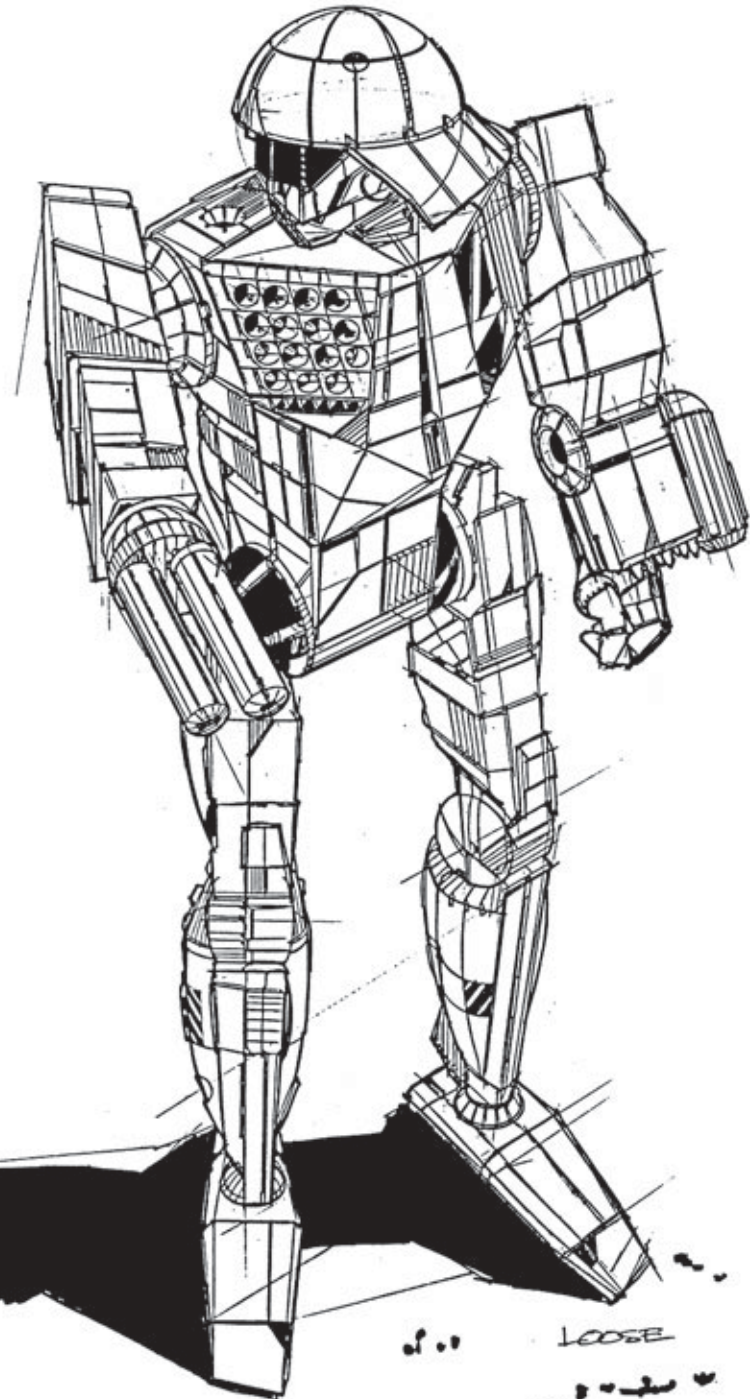

LOOSE

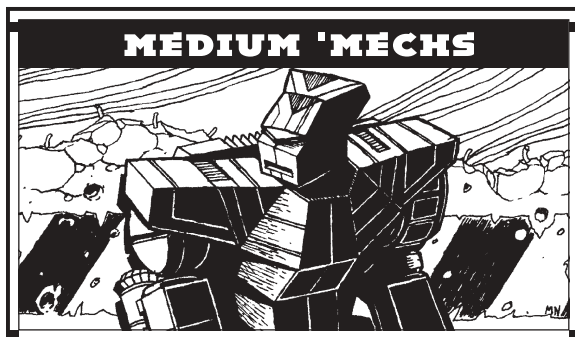

Mass: 55 tons

Chassis: Dorwinion Standard 55T

Power Plant: Core Tek 275

Cruising Speed: 54 kph

Maximum Speed: 86 kph

Jump Jets: Swingline X-100

Jump Capacity: 150 meters

Armor: Maximillian 105

Armament:

2 Federated 10-Shot LRM Missile Systems

2 ChisComp 39 Medium Lasers

2 Federated 2-Shot SRM Missile Systems

Manufacturer: Achernar BattleMechs

Primary Factory: New Avalon

Communications System: Achernar Electronics HID-21

Targeting and Tracking System: Federated Hunter Mk. II

Overview

Designed in 2520, the *Dervish* was one of the first BattleMechs the Great Houses built in quantity. It served as a workhorse of their armies and was later commissioned into the SLDF during the bloody Reunification War. Although given a major update in the twenty-seventh century, numbers have dwindled. Only the Federated Suns continued manufacturing the design during the Succession Wars.

Capabilities

The *Dervish* is a fire-support 'Mech with the twin LRM 10 launchers of its main battery deeply embedded in the 'Mech's torso, where they are well protected. The supporting two-shot SRMs and their fifty-round magazines

are completely self-contained within the 'Mech's paddle-like forearms. Originally these secondary missile launchers were the *Dervish's* only auxiliary weapons, but designers later strapped a medium laser on top of each launcher so that the BattleMech was not completely ammunition-dependent.

The jump jets, originally an afterthought, have proved their worth time and again, giving the *Dervish* the mobility to exploit the surrounding terrain, close quickly with an opponent, or jump out of a tight situation. Two major drawbacks with the design are its relatively weak armor and its lack of hand actuators.

Deployment

The *Dervish* remains one of the Federated Suns most common medium-BattleMech designs, and it is very popular with the Avalon Hussar regiments. The *Dervish* was one of several designs earmarked for the Federated Commonwealth regiments that were formed after the Fourth Succession War. During Deep Periphery explorations, ComStar's Explorer Corps have sighted the original *Dervish* in the ranks of Castilian forces battling the enigmatic Umayyad in Nueva Castile.

Inarguably the most famous event in which the *Dervish* played a role occurred during the First Succession War. By 2796 Kurita forces had driven deep into the Federated Suns to a position where they threatened New Avalon itself. The lightly defended world of New Rhodes III was directly on Kurita's path toward the capital, but the Seventeenth Avalon Hussars had been pulled back to defend New Avalon. Only a small guerrilla force remained.

Taking to the thick forests surrounding the planet's capital, a force of six BattleMechs commanded by Captain Conrad Warrent concealed themselves and waited. When Kurita's Second Sword of Light dropped onto New Rhodes III, they discovered no armed resistance. They began the task of building up a stockpile of supplies to support the final drive on the heart of the Federated Suns.

The Second Sword of Light had rounded up the sullen populace and was busy parading their awesome strength before a captive audience when Warrent's *Dervishes* and *Enforcers* came boiling out of the river bordering the supply dump. Ignoring the enemy for the moment, the *Dervishes*

fired salvo after salvo at the supplies. As one ammunition pile after another blew sky-high, the populace sent up a cheer. Time and again, a *Dervish* emerged from the flames, fired missiles at the Kurita 'Mechs, then disappeared back into the smoke. Holding their fire for fear of destroying even more supplies, it took the Sword of Light ten hours to track down and kill Warrent's command.

To this day historians continue to argue over whether the damage inflicted during this gallant action prevented the invasion of New Avalon. The one undeniable effect of the attack of the "Whirling Dervishes" was that it boosted the morale on both New Rhodes III and on New Avalon, where smuggled tapes of the event were broadcast.

Variants

No production variants of the *Dervish* exist.

The original design used primitive components similar to those used in the first BattleMech, the *Mackie*. During the Reunification War, funds provided by the Terran Hegemony allowed the other League Member States to upgrade their last original-model *Dervishes*, generally found lingering in backwater militias, to the DV-6M standard.

Notable MechWarriors

MechWarrior Hap "Madman" Carsburg: Something of a con man, Carsburg has seen his share of jails. At times when the success of his elaborate cons has brought in a fair sum, he plays the benevolent fool, sporting ridiculous hats and carrying a sword. When he inevitably loses the money, he becomes dark and moody, waiting for the inspiration to create a new scheme.

His erratic behavior during the invasion of Liao in the Fourth Succession War saw Carsburg being cashiered from the Thirty-third Avalon Hussars. Turning to the mercenary life, Carsburg joined the flamboyant Greenberg's Godzillas.

Leftenant Billy Linderman: During the War of 3039, Linderman's fire lance used the new Listen-Kill missiles to cut down fleeing Fourth Ghost Regiment 'Mechs on Rochester. The *Dervish's* speed and mobility allowed the Third Ceti Hussars MechWarriors to stay out of reach of Kuritan PPCs.

DV-6M DERVISH

Type: **Dervish**

Technology Base: Inner Sphere

Tonnage: 55

Battle Value: 1,146

Equipment

		Mass
Internal Structure:		5.5
Engine:	275	15.5
Walking MP:	5	
Running MP:	8	
Jumping MP:	5	
Heat Sinks:	10	0
Gyro:		3
Cockpit:		3
Armor Factor:	120	7.5

	Internal Structure	Armor Value
Head	3	8
Center Torso	18	20
Center Torso (rear)		4
R/L Torso	13	15
R/L Torso (rear)		4
R/L Arm	9	10
R/L Leg	13	15

Weapons

and Ammo	Location	Critical	Tonnage
LRM 10	RT	2	5
Ammo (LRM) 12	RT	1	1
LRM 10	LT	2	5
Ammo (LRM) 12	LT	1	1
Medium Laser	RA	1	1
Medium Laser	LA	1	1
SRM 2	RA	1	1
Ammo (SRM) 50	RA	1	1
SRM 2	LA	1	1
Ammo (SRM) 50	LA	1	1
Jump Jets	RL	2	1
Jump Jets	LL	2	1
Jump Jet	CT	1	.5

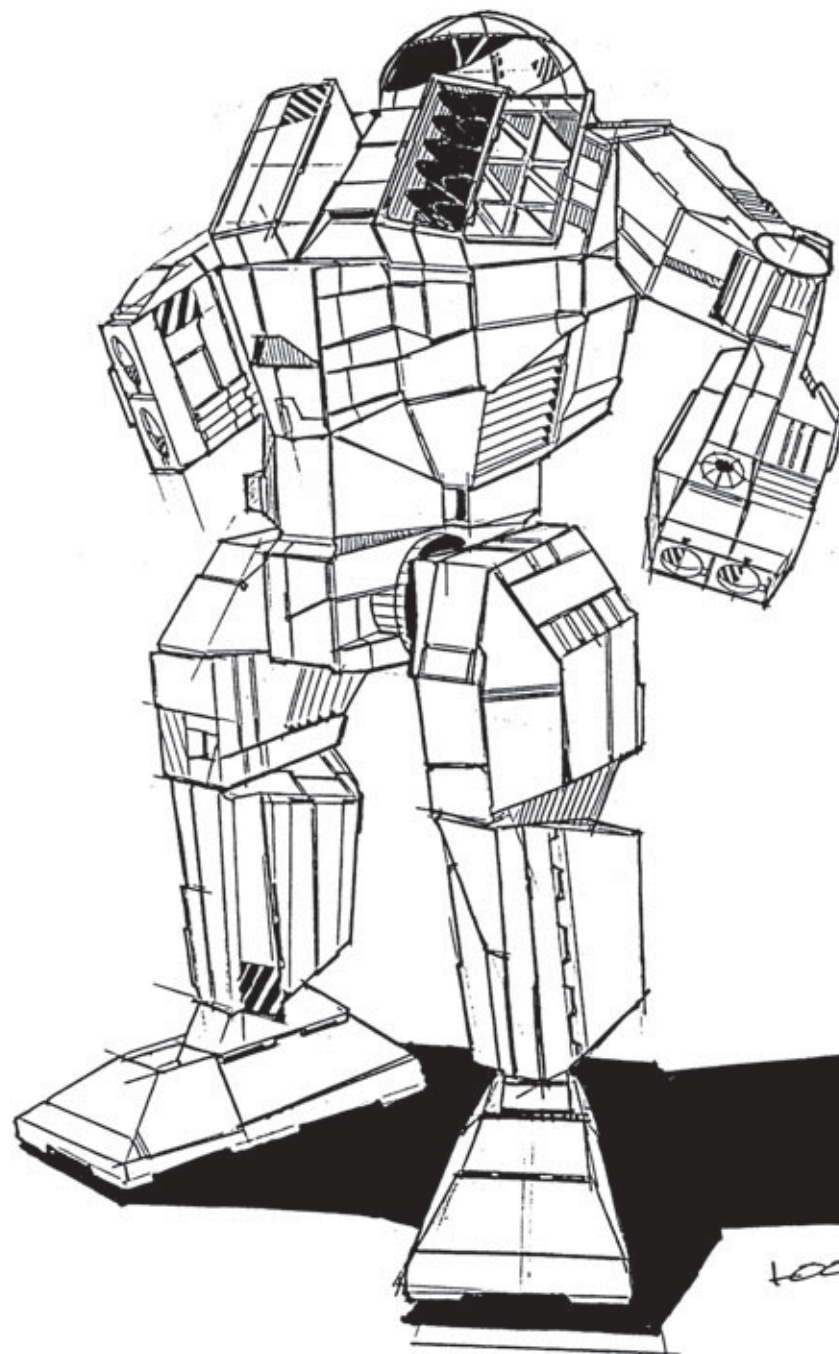

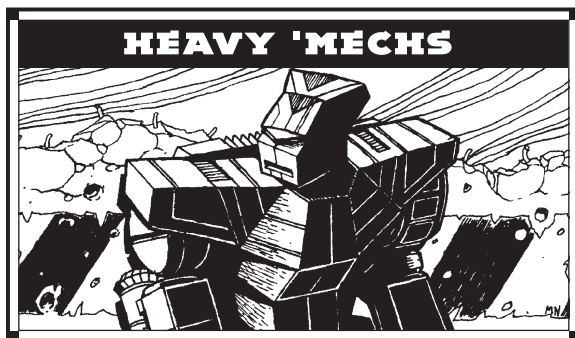

Mass: 60 tons

Chassis: Alshain Type 56-60H

Power Plant: Vlar 300

Cruising Speed: 54 kph

Maximum Speed: 86 kph

Jump Jets: None

Jump Capacity: None

Armor: Starshield

Armament:

1 Telos DecaCluster LRM Missile System

1 Emperor-A Autocannon

2 Victory 23R Medium Lasers

Manufacturer: Luthien Armor Works

Primary Factory: Luthien

Communications System: Sipher CommSys 3

Targeting and Tracking System: Eagle Eye SY10-10

Overview

Although it was designed for sale to the Star League, the *Dragon* was rejected by SLDF purchasing agents in favor of an upgraded version of the *Shadow Hawk*. Luthien Armor Works, amazed and angered by the rejection, pushed the *Dragon* into full production and sold it to the DCMS, where it would soon become the standard BattleMech of the Draconis Combine. In production at various factories since the fall of the Star League and particularly on well-defended Luthien, the *Dragon* is easily the most prominent 'Mech in the Combine arsenal.

Capabilities

A squat BattleMech, the *Dragon* is intended as a strike 'Mech to be used when the battle has stagnated. The designers made the *Dragon* faster than the normal heavy 'Mech with a top speed of 86 kph. This power is provided by a tried-and-true Vlar 300 fusion engine and protected by ten full tons of armor.

Along with its speed, the *Dragon* is armed with an Emperor-A autocannon and a Telos DecaCluster long-range missile rack. These weapons allow the *Dragon* to attack its target during a long charge, using its speed as a deterrent to enemy fire. Missiles and cannon fire soften the target up, and when the *Dragon* closes either a devastating physical attack or concentrated fire from the arm-mounted Victory 23R medium laser finishes the target off.

To support its capabilities as an attack 'Mech, the *Dragon* is endowed with ample ammunition for both of its ranged weapons, allowing it to stay in the field and away from supply lines for extended amounts of time. Although it only mounts ten heat sinks, the weapons load and lack of jump jets means that the *Dragon* is a fairly cool-running BattleMech.

Given its speed and mass, it is not uncommon to see *Dragons* rushing to close range and making devastating charges or other physical attacks. Although the bulk of their weaponry is designed for ranged attacks, the *Dragon* is a deadly in-fighter when grappling with a foe.

Deployment

The *Dragon* appears in every Draconis Combine Mustered Soldiery battalion and in almost every company. Indeed, there are several battalions that are made completely of *Dragons*. It fills nearly every function in a regiment, whether it is attack, defense, harassment, or interdiction. So many have been produced and used that salvage has spread the 'Mech to the Federated Suns and the Lyran Commonwealth in limited numbers, and a large number of mercenaries have captured or bought the design as well.

Because of its origins as a Combine district, the Free Rasalhague Republic uses the *Dragon* as well. In that area of space it is not uncommon to see the *Dragon* fighting alongside, instead of against, Lyran-model BattleMechs like the *Commando* and *Zeus*. There is a strong anti-Kurita sentiment in the newly freed Republic, but it does not yet extend to BattleMechs—*Dragons* and *Panthers* are plentiful and prominent in the Royal KungsArmé.

Variants

The DRG-1G *Grand Dragon* is a major upgrade of the *Dragon*. Mounting a PPC in place of the Emperor, the variant adds two more heat sinks and another medium laser. First produced in the mid-3020s, several of the *Dragon* production lines in the Combine have switched to producing this variant exclusively.

Notable MechWarriors

Sho-sa Leon Gambetta: *Sho-sa* Gambetta of the Second Sword of Light is the oldest MechWarrior on the active rolls of the Second Sword. Gambetta is acknowledged as one of the premier tacticians of the Second Sword, which makes him one of the premier tacticians in the Combine. He is a kind officer, solicitous of his command. He commands the lead company of the Second Sword's third battalion, and his company is often found in the fore of any assault on fortified positions. That a MechWarrior often tasked to such dangerous roles should live so long is unusual.

In 3038 the *Sho-sa's* venerable DRG-1N *Dragon* was replaced with a newly built DRG-1G *Grand Dragon* as a reward for his decades of exceptional service. Strangely, this upgrade has revealed an amateurish flaw in Gambetta's otherwise elite piloting. With the replacement of the Emperor-A by a Lord's Light PPC, Gambetta has almost as much trouble controlling his heat curve as a novice MechWarrior. Decades of piloting a 'Mech with a generous heat curve have apparently left the *Sho-sa* with some bad habits.

Lieutenant Günther "Buzz Saw" Heltschlag: Born into a long-lived MechWarrior mercenary family, Günther earned the nickname "Buzz Saw" at a young age for his abrasive, belligerent personality. That spirit led him to follow Major Dany Cunningham into the formation of Cunningham's Commandos following the Fourth Succession War. Apropos for such a personality, he's an avid boxer, challenging anyone to straight-up fist-a-cuffs at each port of call. This has led to a love of physical attacks when at the helm of his *Dragon*. He likes nothing better than to pound an opponent into the ground with his 'Mech's massive left fist, or, if the perfect opportunity presents itself, to take off a head with a well-aimed kick.

DRG-1N DRAGON

Type: **Dragon**

Technology Base: Inner Sphere

Tonnage: 60

Battle Value: 1,125

Equipment

Internal Structure:

Engine: 300

Walking MP: 5

Running MP: 8

Jumping MP: 0

Heat Sinks: 10

Gyro: 3

Cockpit: 3

Armor Factor: 160

Mass

6

19

0

3

3

10

	Internal Structure	Armor Value
--	--------------------	-------------

Head	3	9
------	---	---

Center Torso	20	27
--------------	----	----

Center Torso (rear)		12
---------------------	--	----

R/L Torso	14	16
-----------	----	----

R/L Torso (rear)		8
------------------	--	---

R/L Arm	10	14
---------	----	----

R/L Leg	14	18
---------	----	----

Weapons

and Ammo

	Location	Critical	Tonnage
--	----------	----------	---------

LRM 10	CT	2	5
--------	----	---	---

Ammo (LRM) 24	LT	2	2
---------------	----	---	---

AC/5	RA	4	8
------	----	---	---

Ammo (AC) 40	RT	2	2
--------------	----	---	---

Medium Laser	LA	1	1
--------------	----	---	---

Medium Laser	LT (R)	1	1
--------------	--------	---	---

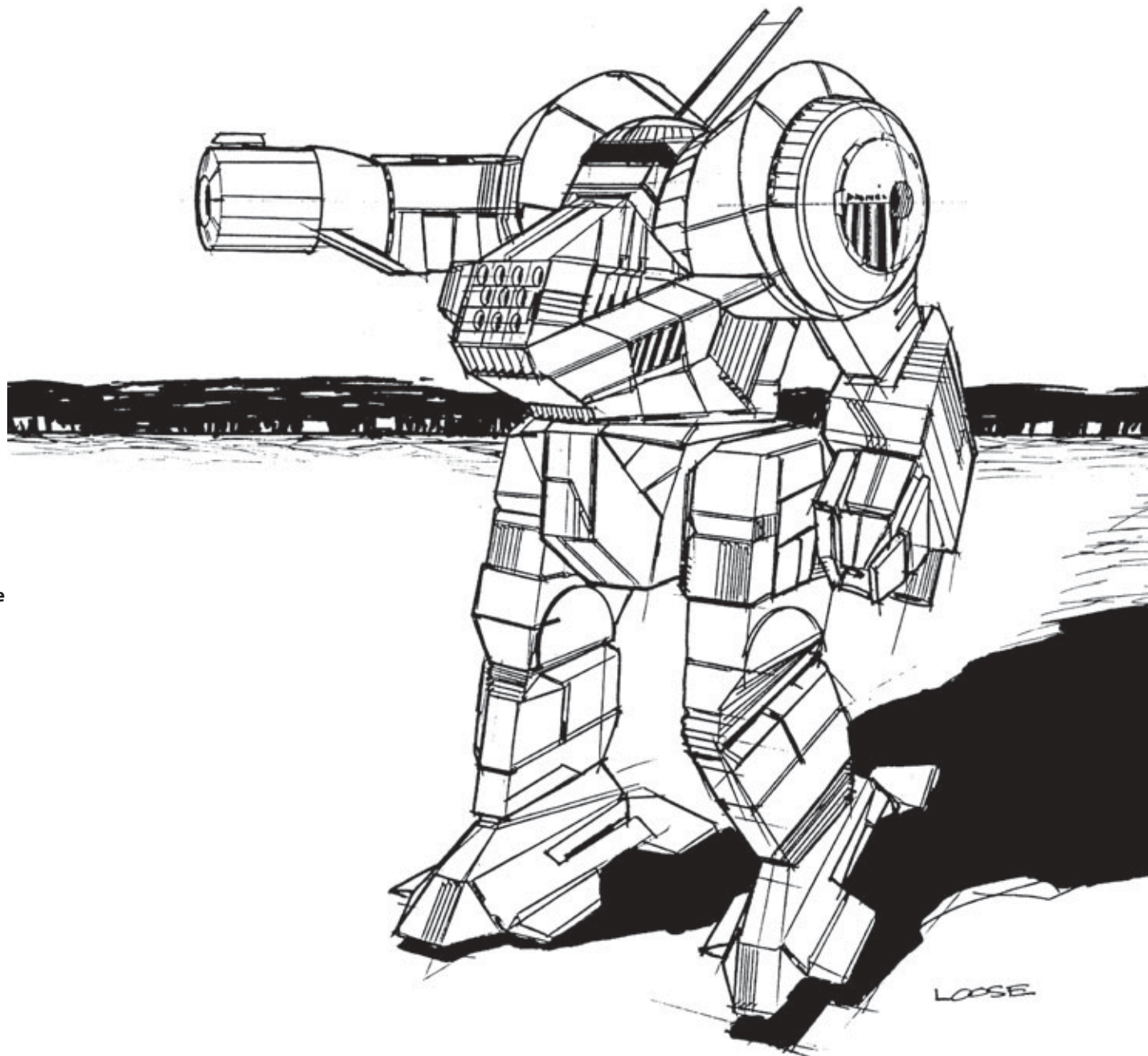

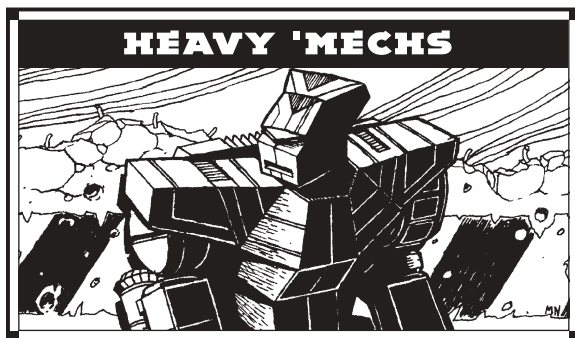

Mass: 60 tons

Chassis: Technicon Type E

Power Plant: Vlar 300

Cruising Speed: 54 kph

Maximum Speed: 86 kph

Jump Jets: Chilton 460

Jump Capacity: 150 meters

Armor: Riese 475

Armament:

4 Omicron 4000 Medium Lasers

1 Delta Dart Long Range Missile 10 Rack

1 Hovertec Short Range Missile Quad

Manufacturer: Technicon Manufacturing,
Luthien Armor Works

Primary Factory: Savannah (Technicon),
Luthien (LAW)

Communications System: Garret T12E

Targeting and Tracking System: Dynatec 2180

Overview

First introduced in 2779, the original QKD-4G *Quickdraw* is a heavy 'Mech that has gradually earned its place as a workhorse in the military of every Great House. Intended to be a replacement for the *Rifleman*, the *Quickdraw* never supplanted the older 'Mech and has become something of a generalist.

Capabilities

The *Quickdraw* suffers from heat dissipation problems that can limit a MechWarrior's ability to use the lasers in protracted engagements, particularly when the jump jets are also employed. Pilots familiar with the design know to

watch their heat indicators and alternate their effective mix of long- and short-range missiles with the energy weapons. In addition to being somewhat quick for a BattleMech of this size, the *Quickdraw's* real advantage in rough terrain is its highly articulated ankle actuator assembly. This assembly—readily identified by its distinctive circular rotor housing—allows the 'Mech to keep its footing on surfaces ranging from gravel to mud to ice and on grades up to twelve degrees steeper than any other machine in its weight class. Unfortunately this enviable versatility comes at a price: notorious fragility. Enemy pilots familiar with the *Quickdraw* know to target the ankle assemblies to quickly hobble the machine. In close-combat situations it is not uncommon for other BattleMechs to attempt to kick or step on a *Quickdraw's* ankle actuator in an attempt to immobilize the machine.

Another unusual feature of the design is the *Quickdraw's* specially modified arm actuators that can bend to the rear if necessary, giving the 'Mech the ability to fire all four medium lasers to the rear.

Deployment

Produced in the Free Worlds League and Draconis Combine, the *Quickdraw* can be found in most military units of these Houses. It can also be found throughout the Lyran Commonwealth and, in lesser numbers, in many Federated Suns militaries. Though House Liao favors designs which spring from worlds within the Confederation, the *Quickdraw* has proven to be popular among many of the less traditional or more progressive units.

Variants

The rearward-facing lasers give the *Quickdraw* some of the most effective rear-arc firepower of any BattleMech, but many pilots prefer to have the majority of their weapons facing forward. The QKD-4H mounts four forward-firing lasers, while the SRM launcher is re-positioned to cover the rear. Another common variant, intended for protracted missions, is the QKD-5A, which reduces the *Quickdraw's* dependence on resupply by replacing the LRM 10 with two additional lasers. Though it adds four heat sinks, they are not sufficient; the heat dissipation problems that plague the base model are exacerbated in this variant, requiring the pilot to husband his weapons carefully in battles of any duration.

Notable MechWarriors

Major Jeffery Saphara: When Lieutenant-General Augst, commander of the Sirdar Capellan March Militia, decided to bloody his command's idle BattleMech elements with a raid on the agricultural world of Thomas in 3011, he did not expect them to meet much resistance. The planet was tactically insignificant, not even included on many star charts, and had few resources to plunder. All that recommended Thomas as a target was a planetary militia with a reputation for dogged tenacity. Unbeknownst to Augst, St. Cyr's Grenadiers, based on nearby Purvo, were using Thomas's North Continent for training maneuvers. The Capellan MechWarriors were every bit as green as those of the Federated Suns, but with a fundamental difference: St. Cyr's Grenadiers had been all but destroyed by Federated Suns forces in 2952 and again in 2985. The motivated Capellans attacked before the AFFS unit was fully deployed, and the speed of the Grenadiers' assault almost resulted in a third defeat.

Augst had held half of his command in orbit, preferring to meet the local defenders in relays rather than a single mass assault that would have crushed their opponents and taught his green MechWarriors nothing about tactics. He ordered the reserve force to land behind the Capellans, catching them in a vise that would have crushed them but for the quick action and able leadership of Major Saphara. Commanding the rear guard, Saphara wheeled his company of light and medium 'Mechs to meet the Davion charge. Surefooted in the rugged Gienstal foothills, Saphara's *Quickdraw* was able to maneuver quickly across terrain that hampered the heavier 'Mechs of the militia. Combining missile fire with jump maneuvers to manage heat effectively, Saphara accounted for an *Orion* and *JagerMech* in single combat while continuing to direct his company against specific targets. Colonel Gladys Turnbuckle credits Saphara's fast thinking and ability to coordinate his command under fire with saving the Grenadiers and preventing their rout.

QKD-4G QUICKDRAW

Type: **Quickdraw**

Technology Base: Inner Sphere

Tonnage: 60

Battle Value: 1,178

Equipment

		Mass
Internal Structure:		6
Engine:	300	19
Walking MP:	5	
Running MP:	8	
Jumping MP:	0	
Heat Sinks:	13	3
Gyro:		3
Cockpit:		3
Armor Factor:	128	8
	<i>Internal Structure</i>	<i>Armor Value</i>
Head	3	9
Center Torso	20	17
Center Torso (rear)		8
R/L Torso	14	14
R/L Torso (rear)		7
R/L Arm	10	11
R/L Leg	14	15

Weapons

and Ammo	Location	Critical	Tonnage
LRM 10	LT	2	5
Ammo (LRM) 12	LT	1	1
SRM 4	CT	1	2
Ammo (SRM) 25	RT	1	1
Medium Laser	LA	1	1
Medium Laser	RA	1	1
Medium Laser	RT (R)	1	1
Medium Laser	RT (R)	1	1
Jump Jet	CT	1	1
Jump Jets	LL	2	2
Jump Jets	RL	2	2

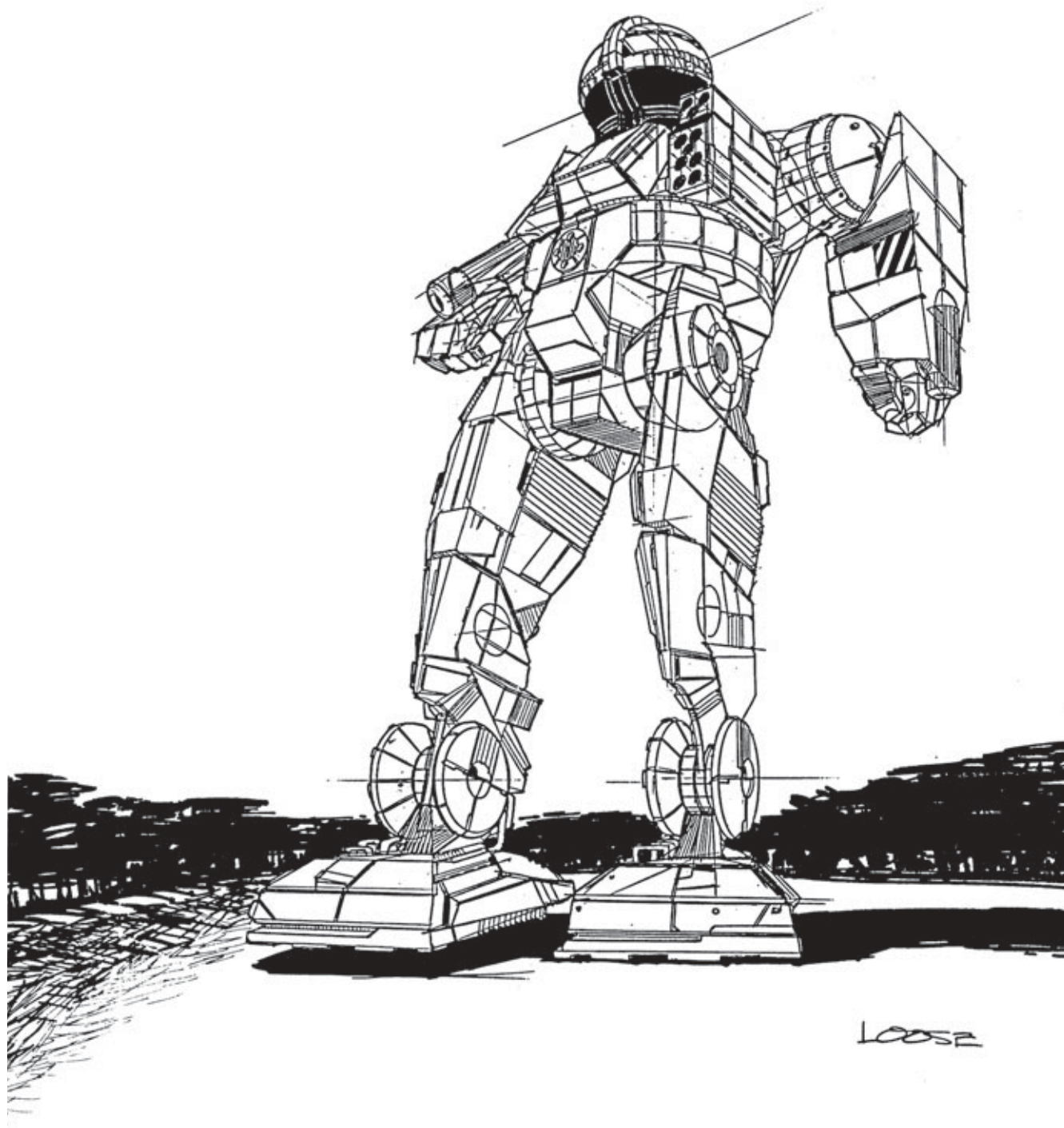

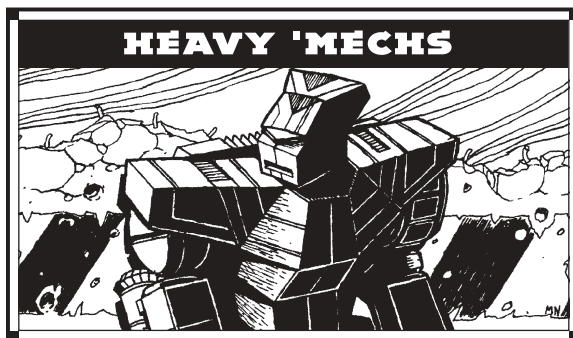

Mass: 65 tons
Chassis: Hollis Mark II
Power Plant: Magna 260
Cruising Speed: 43 kph
Maximum Speed: 64 kph
Jump Jets: Anderson Model 21
 Jump Capacity: 120 meters
Armor: Durallex Heavy
Armament:
 2 Holly Long Range Missile Packs (15)
 4 Martell Medium Lasers
Manufacturer: Hollis Incorporated
 Primary Factory: Corey (destroyed 2791)
Communications System: O/P Com-211
Targeting and Tracking System: O/P 1078

Overview

Hollis Incorporated did things big. When they wanted to test the waters of the BattleMech industry, they did so in grand fashion with a completely new design and a state-of-the-art factory. They shipped out record numbers of *Catapults* for the three-year contract they had with the Terran Hegemony. When it came time to renew the contract in 2563, however, the Hegemony said that while the *Catapult* performed adequately, it was not exactly what they were looking for. Hollis had to rapidly find new applications for the facility, which eventually found fame with the *BattleMaster* seventy years later. With the success of the *BattleMaster*, the *Catapult* was completely ignored and its numbers continued to dwindle. This decline reversed when

Yori Mech Works was contracted by the DCMS to build replacements for the 'Mech, which served the Combine well. Production (initially focused on the CPLT-K2 model) resumed at Al Na'ir in 3033.

Capabilities

The *Catapult* is mainly a fire-support platform built to bring a pair of Holly LRM packs to bear. Its thirty tubes can start punishing an enemy at over 600 meters, before most can respond. When opponents close, four lasers can exploit the punishment the missiles have dealt out. To help deliver that firepower, the *Catapult* has ten tons of armor and fifteen heat sinks. The greatest weakness in the weapons load is the number of reloads for the missiles, which at eight per launcher only borders on the edge of acceptable. The lack of anti-infantry armaments and arms reinforces the need to keep the *Catapult* behind a good battle line when possible.

While the speed is adequate, four Anderson jump jets let the *Catapult* pace faster units over broken terrain. The *Catapult* was initially produced with Anderson Model 21s. These jets are prone to breakdowns that result in the jump jets venting directly into the interior of the 'Mech. This causes catastrophic heat build-up. The League issued a recall and many were replaced with better quality Model 25s, but some *Catapults* never made it back for the recall. Also different is the sidewise ejection system. Regarded as generally safe, it is a surprise to warriors who have never seen a *Catapult's* ejection before.

Deployment

The Star League used the *Catapult* both in second-line and specialist units, such as mountaineering regiments. Many *Catapults* accompanied Kerensky in his Exodus, leaving relatively few behind in second-line units. Of those, most *Catapults* ended up in the Capellan Confederation where Hollis had continued to build spare parts. The Draconis Combine also obtained a sizable group when they seized Dieron. During the Succession Wars, *Catapults* occasionally caused invasions, with House Davion invading Liao several times to secure some of these rare 'Mechs.

Variants

For such a rare 'Mech, the *Catapult* has undergone a lot of tinkering. The CPLT-C4 mounts larger LRM racks at the expense of the lasers and heat sinks. The CPLT-A1 doubles the LRM ammo and adds two tons of armor. House Kurita revamped the 'Mech entirely with their CPLT-K2 variant, which replaces the launchers with PPCs and side torso lasers with machine guns. The jump jets were removed in favor of heat sinks, making it more of a direct fire-support unit. Hollis issued a refit kit for *Catapults* in Royal units in 2688. The heat sinks were upgraded, while more ferro-fibrous armor and ammo were added. Future improvements along these lines were planned for a new series of *Catapults*, but the chaos of the fall of the League and the destruction of Hollis' plant ended those dreams.

Notable MechWarriors

MechWarrior Jenny Templeton: A member of the Chesterton Reserves, Jenny cut down half a dozen Davion warriors in the Fourth Succession War with her *Catapult*, "*Butterbee*." In intense urban combat the attackers regarded her LRM armed 'Mech as only armed with medium lasers. However, Butterbee mounted quad SRM 6 packs instead of the Holly LRM launchers. After a few hit-and-jump attacks with the lasers, Templeton would unleash the missiles. Catching the invaders off guard, the missiles spread out and often hit the holes that her lasers left. If they survived the missile blasts, enemies were usually killed off while still in shock.

MechWarrior Janice Abermann: Janice is an exceptional warrior with a rather unsettling personality. A terror on the battlefield, she treats all her opponents and support staff with contempt. Her fashion sense harkens back to mid-28th century neo-gothic, but it doesn't stop men and women from making fools of themselves over her in bars after hours.

CPLT-C1 CATAPULT

Type: **Catapult**

Technology Base: Inner Sphere

Tonnage: 65

Battle Value: 1,399

Equipment

		Mass
Internal Structure:		6.5
Engine:	260	13.5
Walking MP:	4	
Running MP:	6	
Jumping MP:	4	
Heat Sinks:	15	5
Gyro:		3
Cockpit:		3
Armor Factor:	160	10

	Internal Structure	Armor Value
Head	3	9
Center Torso	21	24
Center Torso (rear)		11
R/L Torso	15	19
R/L Torso (rear)		8
R/L Arm	10	13
R/L Leg	15	18

Weapons

and Ammo	Location	Critical	Tonnage
LRM 15	RA	3	7
Ammo (LRM) 8	RT	1	1
LRM 15	LA	3	7
Ammo (LRM) 8	LT	1	1
Medium Laser	RT	1	1
2 Medium Lasers	CT	2	2
Medium Laser	LT	1	1
Jump Jets	RT	2	2
Jump Jets	LT	2	2

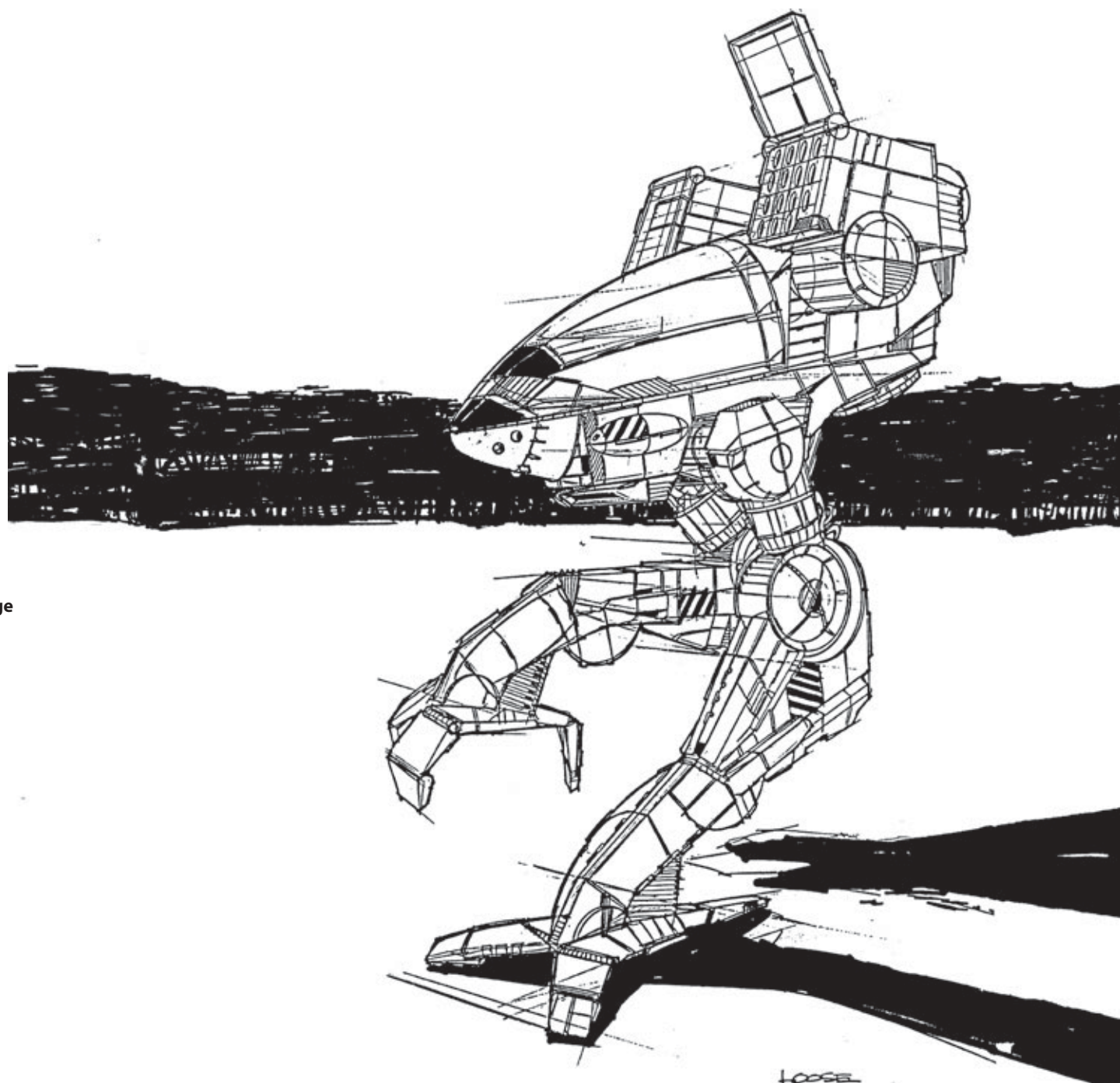

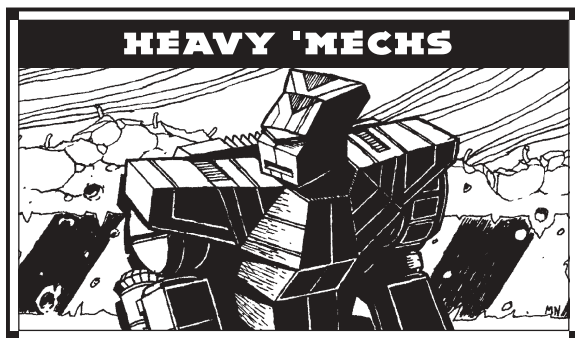

Mass: 65 tons

Chassis: Kallon Type XII

Power Plant: Magna 260

Cruising Speed: 43 kph

Maximum Speed: 64 kph

Jump Jets: None

Jump Capacity: None

Armor: Kallon Royalstar

Armament:

2 Mydron Model C Medium Autocannons

2 Mydron Model D Light Autocannons

2 Magna Mk. II Medium Lasers

Manufacturer: Kallon Industries

Primary Factory: Talon

Communications System: Garrett T11-A

Targeting and Tracking System: Garret D2j

Overview

After the success (despite its limitations) of the *Rifleman*, Kallon Industries decided to see if the 'Mech could be improved. In reviewing the *Rifleman's* performance, Kallon engineers discovered that it was under-armored, lacking in ammunition, and prone to overheating. In designing the *JagerMech* they tried to keep the best of the *Rifleman* while addressing its key deficiencies.

Two out of three isn't bad.

Although they were able to reduce the ammunition problem and all but eliminate the *Rifleman's* heat burden, there was simply no way to increase the 'Mech's armor protection and retain the same weapons profile.

AFFS procurement officers, impressed with what they saw, approved the design anyway, and the *JagerMech* began standard production.

Capabilities

The key feature of the *JagerMech* is the battery of four autocannons that gives it a deadly direct fire-support capability. Two each of Mydron's Models C and D cannons are mounted, one of each in either arm, and are provided with plentiful ammunition. A pair of Magna Mk. II medium lasers in the torso provide close-in defense, and without the *Rifleman's* large lasers, the *JagerMech's* heat curve is far more manageable. The only flaw in the *JagerMech's* design is the lack of heavy armor to protect it. Kallon responds to this charge, however, by pointing out that the *JagerMech* is intended as a second line 'Mech, staying far behind the main battle lines to pour cannon fire into the enemy at range.

Like the *Rifleman*, the *JagerMech* is a strong anti-aircraft platform. It uses the same Garret D2j targeting and tracking system as the smaller 'Mech, and its weapons are just as accurate when selected for anti-air firing. With its larger ammunition reserves, the *JagerMech* is often the preferred anti-air unit.

Deployment

With their main production facility on Talon, the *JagerMech* is a popular 'Mech in the Federated Suns. The loss of Quentin and the Independence Weaponry factories there during the War of 3039 brings into question the ability of the AFFS to keep the JM6 to themselves, but even captured *JagerMechs* have never been popular in the DCMS. House Liao uses many reconditioned *JagerMechs* captured in combat, but the large majority of the design still serves House Davion.

In AFFS RCTs, *JagerMechs* form the backbone of fire support lances, together with *Dervishes* and the steadfast *Rifleman*. They are also present, often as supporting members, in attack and strike lances, where they can use their cannon to support their lancemates as they advance. While the Model D doesn't deliver heavy damage, its range makes it excellent for suppression fire.

Variants

The JM6-A variant is designed as a better anti-aircraft platform, with the medium autocannon being replaced by Zeus LRM 15 batteries. Kallon only dedicated two production runs to this variant, and most of them are found in Davion RCTs. In several cases the JM6-A has been pressed into ground combat, where it serves as admirably as the standard JM6-S.

Notable MechWarriors

"Devil" Donald Vincent: A former mercenary, Devil Don is a freelance MechWarrior who often flirts with banditry. Most recently Devil Don took a contract to help defend a small factory on Jonathan during the Fourth Succession War. He and his *JagerMech* were out when the AFFS arrived to take control. Citing his contract, he prepared to engage the armored company sent to capture the factory. When he failed to move immediately, the Davion company ignored him and fired a barrage into the factory. As the fires burned out of control, Vincent simply turned and watched. When questioned later, he shrugged. "I was contracted to defend the factory," he said. "With the factory burning, what point was there in getting in a fight?"

Subcommander Bennett Chang: Bennett Chang serves in the Red Guards, where his *JagerMech* is maligned as a Davion toy. Subcommander Chang, however, sees advantage in using a Davion-sponsored 'Mechs against its originators. He and his techs have perfected the art of painting the standard colors of a dozen Davion regiments on the front side of his 'Mech so that it appears to be a Davion line unit from the front side. However, to reduce friendly-fire incidents, they always paint a large Capellan insignia across the *JagerMech's* broad back. While he has not yet been able to test this deception in the field, it has made him the recognized concealment expert in his regiment.

JM6-S JAGERMECH

Type: **JagerMech**

Technology Base: Inner Sphere

Tonnage: 65

Battle Value: 901

Equipment

Internal Structure:

Engine: 260

Walking MP: 4

Running MP: 6

Jumping MP: 0

Heat Sinks: 10

Gyro: 3

Cockpit: 3

Armor Factor: 96

Mass

6.5

13.5

0

3

3

6

	Internal Structure	Armor Value
Head	3	9
Center Torso	21	16
Center Torso (rear)		5
R/L Torso	15	13
R/L Torso (rear)		3
R/L Arm	10	6
R/L Leg	15	11

Weapons

and Ammo

Location	Critical	Tonnage
RA	4	8
RA	1	6
RT	1	1
LA	4	8
LA	1	6
LT	1	1
CT	1	1
RT	1	1
LT	1	1

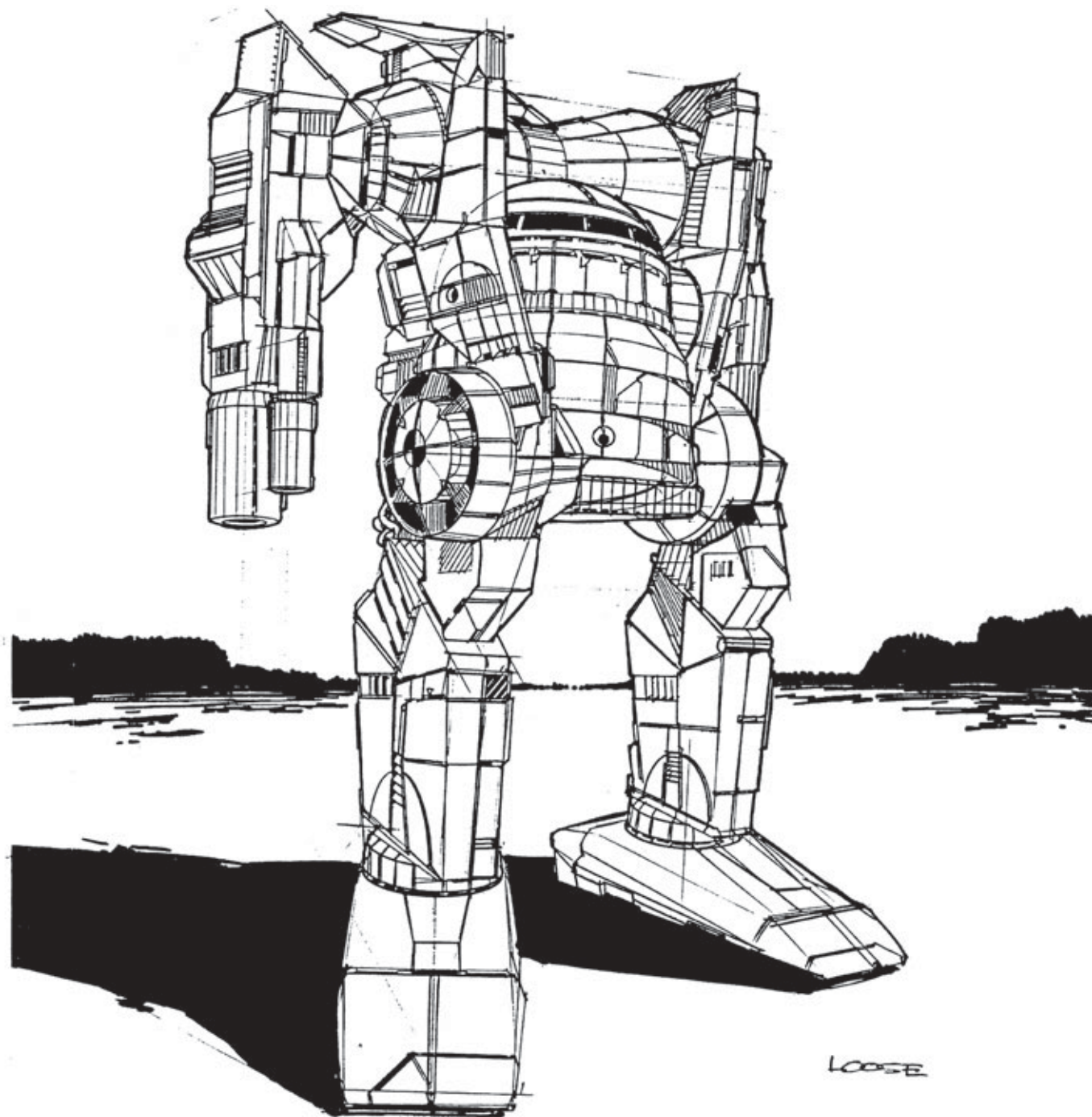

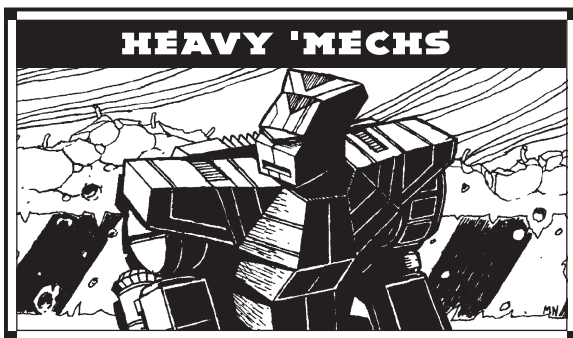

Mass: 70 tons
Chassis: Mingh z33/7
Power Plant: VOX 280
Cruising Speed: 43 kph
Maximum Speed: 64 kph
Jump Jets: Leviathon Lifters
Jump Capacity: 120 meters
Armor: Durallex Heavy
Armament:
 1 Diplan HD Large Laser
 4 Diplan M3 Medium Lasers
 1 Conan/S LRM 5
Manufacturer: Lantren Corporation
Primary Factory: Bryant (destroyed 2843)
Communications System: Allet-C308
Targeting and Tracking System: Allet-T11

Overview

A rushed design intended to fight in the various pent-up areas on Terra in both overt and covert operations, the *Grasshopper* would miss the climatic end of the Amaris Coup due to difficulties integrating several stealth systems with the chassis. With the campaign over before testing could begin, many of the new technological features were stripped out before production started in 2780, and distribution of the untested design occurred throughout the Regular army instead of the more prestigious Royal divisions. As defections occurred before the Exodus, Houses found themselves inheriting this unorthodox design.

Worsening global storms and battle-damaged biodomes led to the evacuation of the Bryant plant during

the Second Succession War, ending the *Grasshopper's* production. But due to its capabilities, many units prioritized repair and rebuilding of the heavy design over other damaged units, sometimes even the commander's own machines, leading to a very high percentage of the original production runs still in fighting condition centuries later.

Capabilities

While under-armed when compared to designs of similar weight, in all other aspects the *Grasshopper* is consistently equal or better than other heavy designs. Nearly two dozen heat sinks keep the machine cool in all but the most intense situations. This is a stark contrast to other popular designs such as the *Warhammer* and the *Marauder*. Jump jets assist in keeping the BattleMech out of harm's way, and thirteen tons of armor keep its internals protected in case damage becomes unavoidable.

Mounting an array of medium lasers spread out between torsos and arms, this design can return fire from just about any angle with a mere torso twist. The most favored design feature, however, is the reliable Diplan HD large laser placed in the center of the torso. Even if the BattleMech loses both its arms and incurs damage to both sides of the torso, the pilot can fire its main weapon as long as the machine is upright. This has led many to classify the *Grasshopper* as a "zombie" design in the league of machines such as the *Awesome*, which can take unheard of damage before finally being destroyed.

For longer-range exchanges, an LRM 5 is the unit's sole ammo-using weapon. Too small to have any real effect, pilots often fire the missiles continually, softening up targets until they could get in range to bring the lasers to bear. In an extended campaign, many pilots will often not bother reloading it, instead allowing less self-reliant designs to draw from the LRM stockpiles, which also has the side effect of making the *Grasshopper* immune to any possibility of an ammo explosion.

Deployment

An uncommon but popular design, the *Grasshopper* and its capabilities remained unknown to many units until ComStar published *Technical Readout: 3025* shortly before

the outbreak of the Fourth Succession War. This led to many units treating the 'Mech as a typical heavy design until it got close, where it would leap into the middle of the attackers' formation and disrupt any plan the enemy's commander might have.

Commanders have used *Grasshoppers* in many light and medium companies as a back-up brawler. As lighter units draw the enemy away from support, many are surprised to see such a heavy and yet so mobile BattleMech anchoring the force.

Variants

Many pilots have tinkered with their *Grasshoppers* over the centuries, but no common variants have surfaced. [EDITOR'S NOTE: Even now, decades into the technological renaissance, the original 5H model is still so popular it outnumbers the upgraded 5J version by a ratio of three to one. Only the Draconis Combine, with its recent C3 variants, employs more upgraded models than originals.]

Notable MechWarriors

Överste-Löjtnant Tor Miraborg: In charge of many of the small unit operations ordered to hunt down the *ronin* resistance groups fighting throughout the Free Rasalhague Republic, Tor and his *Grasshopper* not only led the attacks, but also served as the rear guard when retreating. Tor has been injured twice in combat, suffering light wounds when witnesses thought he should have been killed. The *Överste-Löjtnant* credits his well-designed *Grasshopper* for his survival.

Force Commander Thomas Henten: Henten was the officer in charge of the Marik raiding force that attacked Bryant's Lantren Corporation in 2843 and damaged the factory's protective domes, which had been constructed after the planet's Star League-era Storm Inhibitors were destroyed. Force Commander Henten filled several cargo transports with *Grasshopper* spare parts for his personal machine, the "Red by Night." Now piloted by a distant descendant, the Red by Night still draws from this cache of spare parts and is in pristine condition.

GHR-5H GRASSHOPPER

Type: **Grasshopper**

Technology Base: Inner Sphere

Tonnage: 70

Battle Value: 1,427

Equipment

		Mass
Internal Structure:		7
Engine:	280	16
Walking MP:	4	
Running MP:	6	
Jumping MP:	4	
Heat Sinks:	22	12
Gyro:		3
Cockpit:		3
Armor Factor:	208	13

	<i>Internal Structure</i>	<i>Armor Value</i>
Head	3	9
Center Torso	22	30
Center Torso (rear)		13
R/L Torso	15	20
R/L Torso (rear)		10
R/L Arm	11	22
R/L Leg	15	26

Weapons

and Ammo	Location	Critical	Tonnage
Large Laser	CT	2	5
Medium Laser	RA	1	1
Medium Laser	LA	1	1
Medium Laser	RT	1	1
Medium Laser	LT	1	1
LRM 5	H	1	2
Ammo (LRM) 24	RT	1	1
Jump Jets	RL	2	2
Jump Jets	LL	2	2

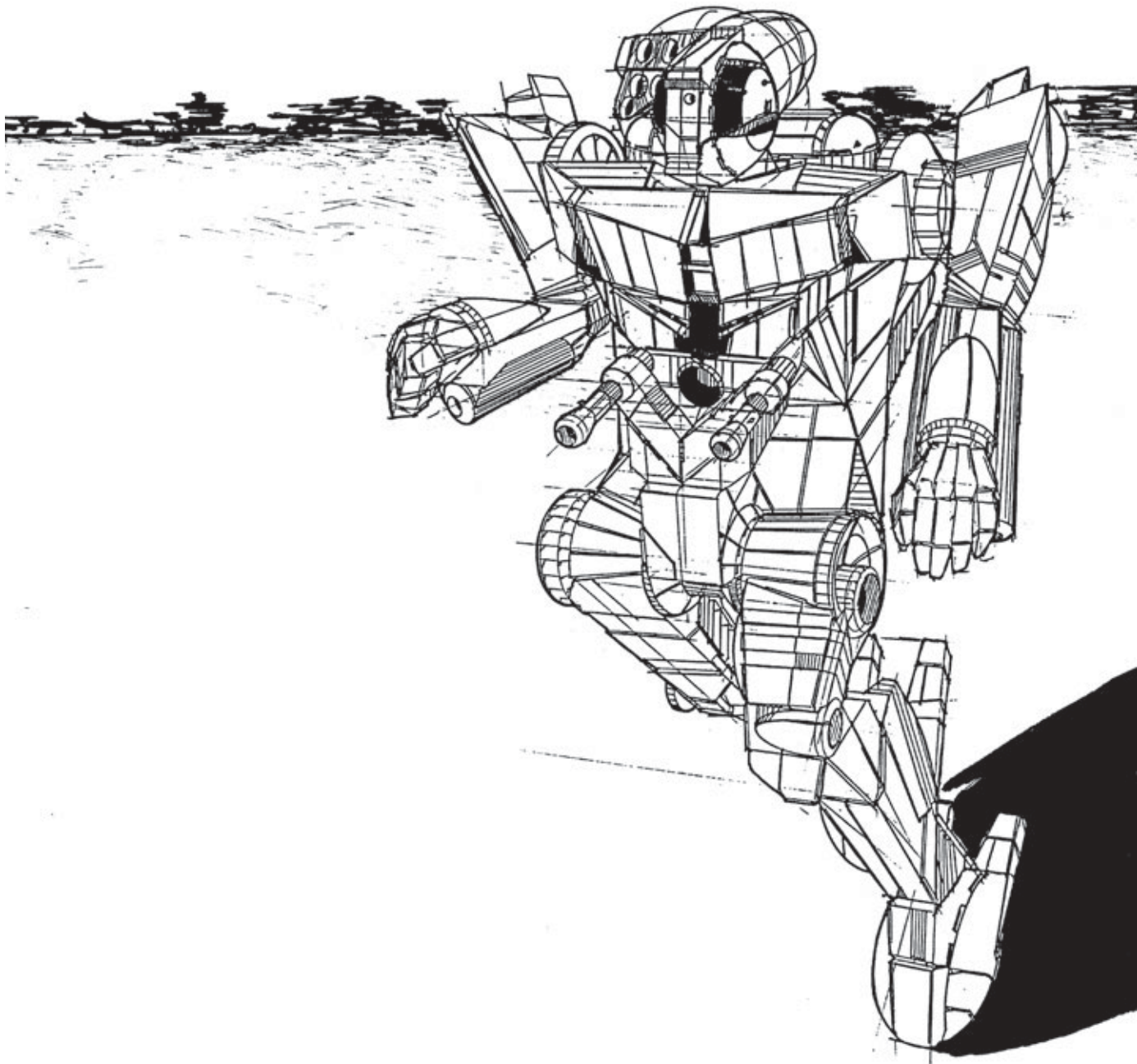

LOOSE

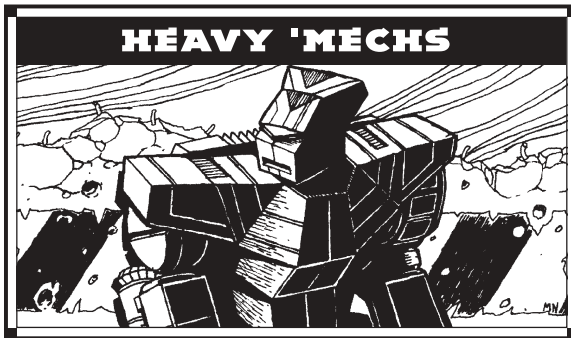

Mass: 75 tons

Chassis: KaliYama Chassis

Power Plant: Vlar 300

Cruising Speed: 43 kph

Maximum Speed: 64 kph

Jump Jets: None

Jump Capacity: None

Armor: Valiant Lamellor

Armament:

1 KaliYama Class 10 Autocannon

1 KaliYama Death Bloom Missile System

2 I.W.W. Medium Lasers

1 I.W.W. Class 4 S.R. Missile System

Manufacturer: KaliYama/Alphard Trading Corp.,
KaliYama Weapons Industries

Primary Factory: Kendall, Kalidasa

Communications System: Irian Orator-5K

Targeting and Tracking System: Wasat Aggressor
Type 5

Overview

Sometimes called “a poor man’s *Atlas*” since the introduction of that behemoth, the *Orion* is a venerable, general-duty heavy ‘Mech—and a famous one. Everyone has seen the images of Aleksandr Kerensky storming Amaris’ last defenses on Terra, making the *Orion* one of the best known ‘Mechs in history.

Commissioned by the Terran Hegemony in response to improving ‘Mech designs used by other Houses, the *Orion* is nearly half a millennium old. The roomy chassis has allowed it to be readily upgraded and maintained over the centuries.

Capabilities

Mounting over fourteen tons of armor and a weapons load leaning toward ballistic options, the *Orion* is a hardy ‘Mech that can take a pounding. The Death Bloom and KaliYama autocannon are then able to give as much abuse as the ‘Mech gets. The autocannon is a solid weapon, but the loading system often jams if the ammo bin is full, so most warriors only load nineteen salvos. (In the 3030s, a then-small Commonwealth manufacturer, Norse-Storm Technologies, made a killing with their upgrade to the loading system that corrected the jamming issue.) Backing up the long-ranged weaponry are a pair of Irian Weapon Works lasers and an SRM system that exploits holes in enemy armor dug by the *Orion*’s larger weapons. Some care is required to avoid overheating, but any experienced *Orion* pilot can alternate the weapons sufficiently to avoid any serious issues.

These capabilities were showcased when the *Orion* was the centerpiece of Katrina Steiner’s rescue of the Defiance BattleMech factory on Hesperus II in 2997. After jumping from one continent to another, a company including four *Orions* performed a combat drop onto Marik positions. While the Marik forces focused on the *Warhammers*, *Zeuses* and *BattleMasters*, the *Orions* were able to close and start wreaking havoc at close range. By the time the focus turned to the *Orions*, it was too late as their armor was too thick for the Marik forces. This opened a hole in the invader’s line that the Lyrans were able to move through and reclaim Hesperus II.

Deployment

The *Orion* can be found almost everywhere in the Inner Sphere and the better-equipped Periphery powers, including the up-and-coming Marian Hegemony. Originally built on Hesperus II, *Orions* were a mainstay of the Hegemony Forces. KaliYama took over production after the fall of the Star League but used their own autocannon to increase profits. The largest concentration of *Orions* can be found in the Free Worlds League where they are still manufactured. There are complaints in the League that the Marik Militia receives far more than their fair share of *Orions* coming from Kendall and Kalidasa.

Variants

With so many nations using *Orions* for so long, it is no surprise that there are many variants. Many of these are simple field refits or repositioning weapons to suit pilot preference. The only variants that are seen regularly involve adding a second SRM launcher. The ON1-V relocates the SRM launcher to the left arm while adding another to the right. A ton of ammunition is also added, all at the cost of a drop in armor protection. This can be a problem for some targeting systems, so some versions remove the LRM system. The ON1-VA mimics the configuration of the ON1-V but keeps the armor and adds six heat sinks in place of the Death Bloom launcher. This makes for a nasty infighter that excels in urban or jungle combat.

Notable MechWarriors

MechWarrior Sylvan Greenspan: This Wolf’s Dragoon MechWarrior prefers close quarters battle that tends to leave her *Orion*, “*Phoenix*,” half wrecked. Fortunately, she’s also a skilled technician and insomniac. Following battles, she generally disappears into the repair bay with a pile of parts, and the next morning her machine emerges whole, like its legendary namesake. She managed to keep her ‘Mech in perfect form through battles on Misery and Harrow’s Sun, where a fluke shot sent a shard of display screen into her heart, leaving her and her ‘Mech nearly pristine in death.

Hauptmann Carter Prescott III: Hauptmann Prescott is well regarded in the Third Lyran Royal Guards for both his tactics and leadership qualities. Not only can he lead from the field, he is also a talented teacher of his skills to younger warriors. He often paints his *Orion* to commemorate one of his ancestors. However, the ancestor seems to change on a weekly basis, and those who have seen his work have noted he seems to be related to an unbelievably high number of famous historic figures. His troops and superiors overlook his eccentricity in light of his skills.

ON1-K ORION

Type: **Orion**

Technology Base: Inner Sphere

Tonnage: 75

Battle Value: 1,429

Equipment

		Mass
Internal Structure:		7.5
Engine:	300	19
Walking MP:	4	
Running MP:	6	
Jumping MP:	0	
Heat Sinks:	10	0
Gyro:		3
Cockpit:		3
Armor Factor:	231	14.5

	Internal Structure	Armor Value
Head	3	9
Center Torso	23	36
Center Torso (rear)		10
R/L Torso	16	22
R/L Torso (rear)		10
R/L Arm	12	24
R/L Leg	16	32

Weapons and Ammo

	Location	Critical	Tonnage
AC/10	RT	7	12
Ammo (AC) 20	RT	2	2
Medium Laser	RA	1	1
LRM 15	LT	3	7
Ammo (LRM) 16	LT	2	2
SRM 4	LT	1	2
Ammo (SRM) 25	LT	1	1
Medium Laser	LA	1	1

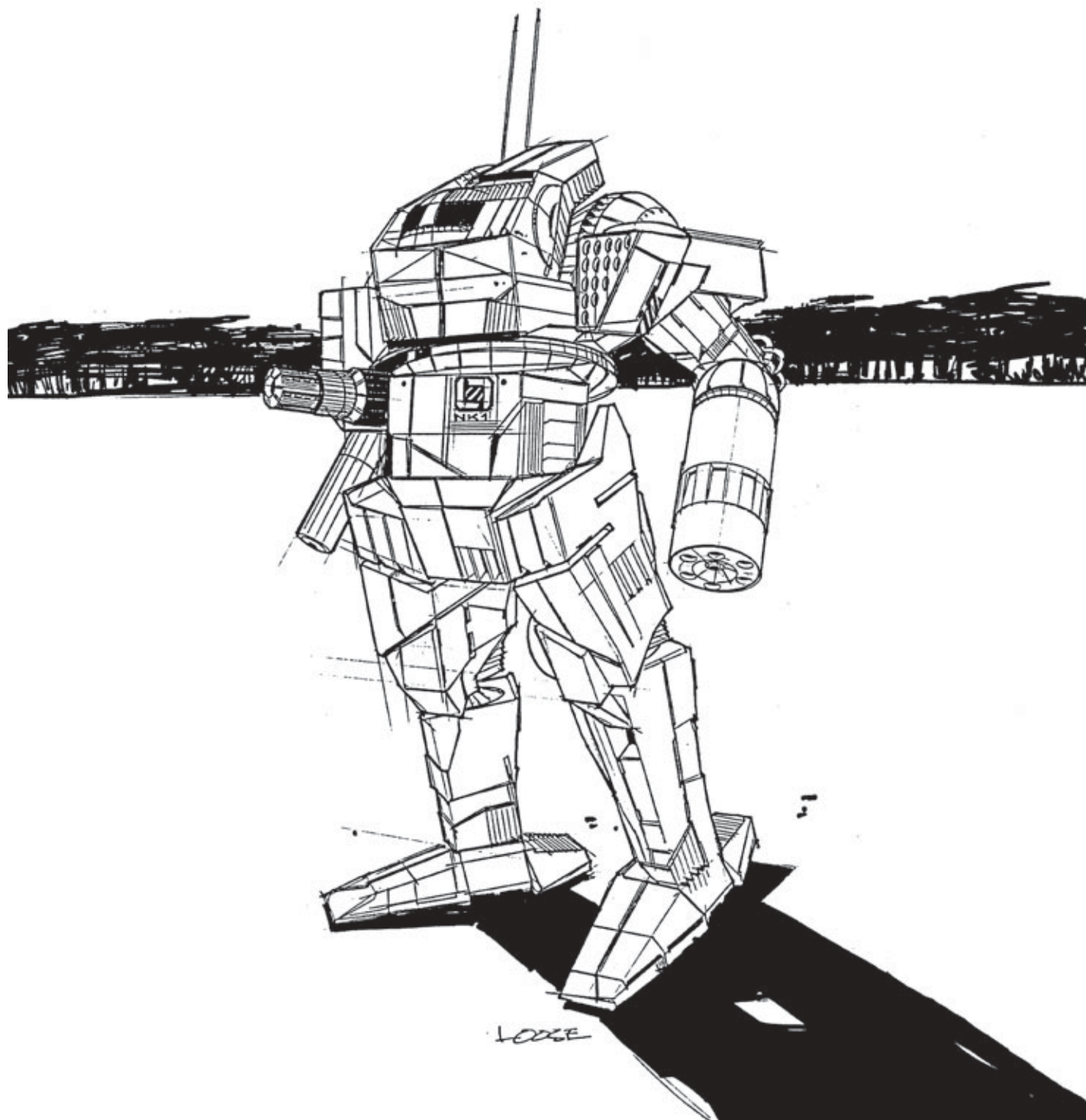

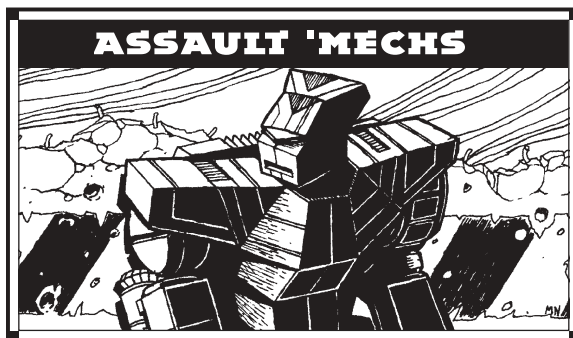

Mass: 80 tons

Chassis: Technicon Type G

Power Plant: Pitban 240

Cruising Speed: 32 kph

Maximum Speed: 54 kph

Jump Jets: None

Jump Capacity: None

Armor: Durallex Heavy Special

Armament:

3 Kreuss Particle Projection Cannon

1 Diverse Optics Type 10 Small Laser

Manufacturer: Technicon Manufacturing

Primary Factory: Savannah

Communications System: Garrett T19-G

Targeting and Tracking System: Dynatec 2780

Overview

Commissioned in 2665 for the Star League by the Technicon Conglomerate, the *Awesome's* design was based on the aging STR-2C *Striker*. While not as swift as its ancestor, the *Awesome* is an extremely powerful assault 'Mech. It is not uncommon for BattleMechs to retire the field rather than face a formation containing *Awesomes*. Its capabilities and battle record have made the *Awesome* a popular and common assault 'Mech in the armies of the Inner Sphere.

The *Awesome* is most commonly used to assault a fixed position or to breach the line of the enemy. They are also sought after for defensive operations. MechWarriors

piloting the *Awesome* can expect to be in the heaviest combat and to be tasked with obtaining the most critical objectives, or at least with guarding such objectives from the enemy.

Capabilities

The *Awesome's* capabilities rely almost exclusively on its three Kreuss particle projection cannons. Supported by twenty-eight heat sinks, the AWS is capable of sustaining a heavy and steady barrage from its weaponry. With one-and-a-half tons of additional armor compared to the *Striker*, the AWS is better protected than even the *BattleMaster*.

As with every BattleMech, the *Awesome* is not without flaws. While devastating at range, it is less efficient in point-blank combat, where its PPCs have a harder time connecting with the target. It only has a Diverse Optics small laser and its left fist to fall back on in that situation. Its reduced mobility makes it vulnerable to flanking attacks by faster opponents who eagerly seek to get clear of the PPCs. While they face some of the thickest rear armor found on any BattleMech, the lack of rear facing weapons, or of a weapon mount on the *Awesome's* left arm, have given many MechWarriors a fighting chance against it.

When properly deployed by commanders who are aware of the AWS' weaknesses, formations of *Awesomes* (or even those with just a few) are extremely effective and very difficult to stop or defeat.

Deployment

Awesomes can be found in every House military. As the Free Worlds League controls the only surviving manufacturing plants capable of producing the *Awesome*, it also operates the largest amount of *Awesomes* of any of the Great Houses. Within the League, opinions of the 'Mech vary wildly. Many praise its capabilities, whereas others find its limited mobility too great a price to pay for what it can do. Similar attitudes exist with the other Houses, but none of them are in a position to debate the point beyond academics. There are few commanders who are not eager to get their hands on an *Awesome* for their unit.

Variants

As with every BattleMech that relies on energy weapons, the AWS-8Q taxes its heat sinks greatly. As a consequence, the most common and widespread variants of the *Awesome* replace one or more of its PPCs. The AWS-8R replaces the PPCs with a large laser and two LRM 15 racks. Based on the 8R, the 8T removes five heat sinks to add another large laser. Lastly, the 8T replaces the torso-mounted PPCs with a large laser and LRM 15 rack. However, the lasers are no substitute for a PPC, and the addition of LRM launchers add the logistics and endurance issues of ammunition-based weaponry, so variants along these lines are generally considered inferior to the 8Q configuration.

Notable MechWarriors

Lieutenant Giles "The Bangers" Barners: Barners is considered the ace *Awesome* MechWarrior of House Kurita with seventy-one confirmed 'Mech kills. Barners' lance of black-painted *Awesomes* formed the backbone and fist of Brion's Legion's Wernke Battalion. Barners' *Awesomes* fought a rear-guard action on David during the Fourth Succession War, holding off the Twelfth Deneb Light Cavalry long enough for the rest of the Legion to reach the safety of the local ComStar station.

Leftenant Danielle Peterson: As a member of the Chisholm's Raiders, Peterson has a petite build and physical beauty that is atypical of MechWarriors and seemingly at odds with her *Awesome's* appearance. She is highly regarded for her exceptional piloting ability, and the extraordinary agility and performance she displays in her BattleMech have been well documented. Seemingly uninhibited by the *Awesome's* typical lack of maneuverability, Peterson's incredible skills have made her and her *Awesome* ("Pretty Baby") famous in all the Successor States. Several Solaris VII stables have offered her tremendous financial rewards were she to retire and join them, but so far she has publicly maintained that her allegiance to the Federated Suns, and she claims she does not intend to retire until they are done with her.

AWS-8Q AWESOME

Type: **Awesome**

Technology Base: Inner Sphere

Tonnage: 80

Battle Value: 1,605

Equipment

Internal Structure:

Engine:

Walking MP:

Running MP:

Jumping MP:

Heat Sinks:

Gyro:

Cockpit:

Armor Factor:

Mass

8

11.5

240

3

5

0

28

18

3

3

15

Internal Structure

Armor Value

Head

3

9

Center Torso

25

30

Center Torso (rear)

19

R/L Torso

17

24

R/L Torso (rear)

10

R/L Arm

13

24

R/L Leg

17

33

Weapons

and Ammo

Location

Critical

Tonnage

PPC

RA

3

7

PPC

RT

3

7

PPC

LT

3

7

Small Laser

H

1

.5

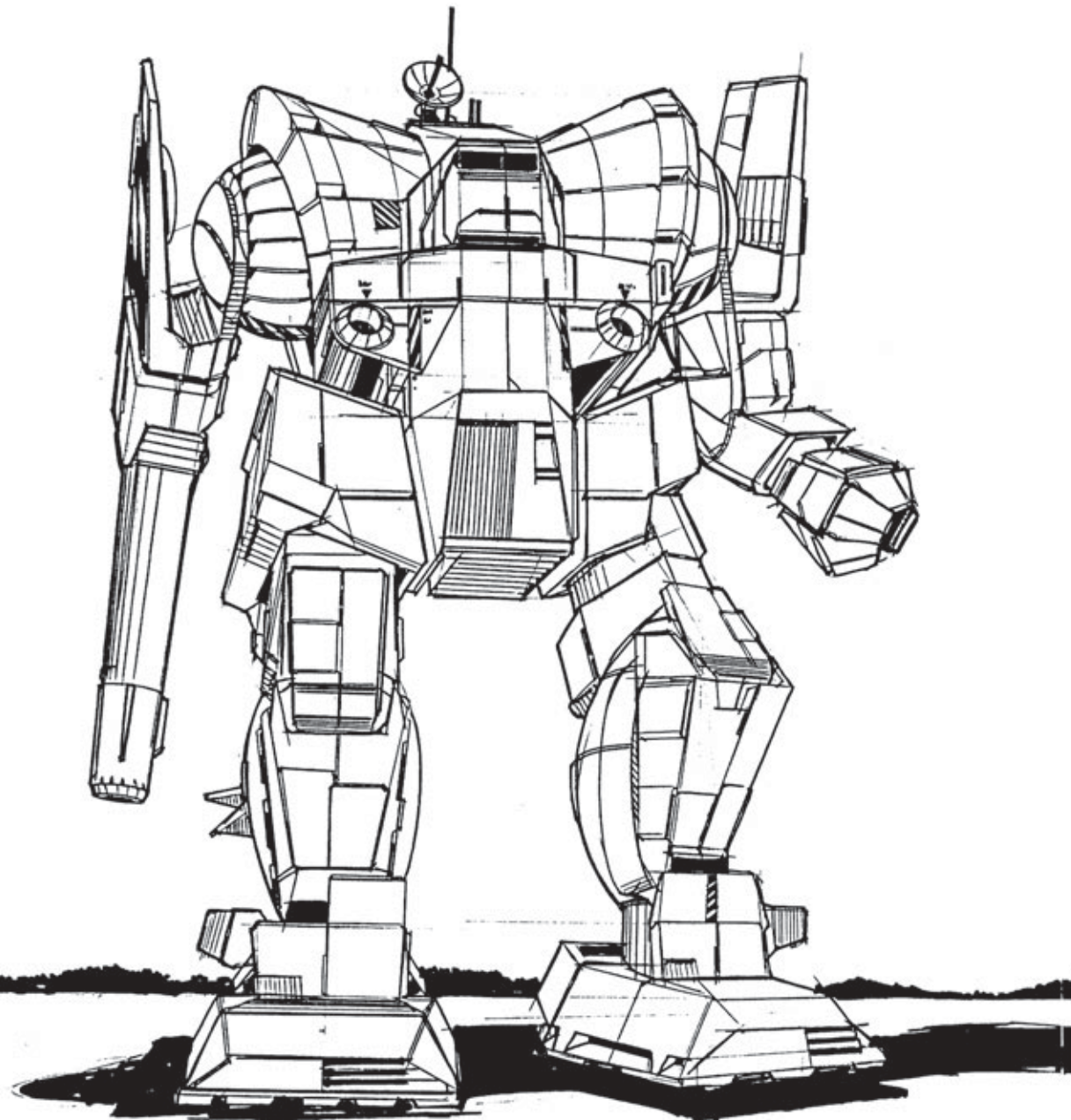

LOOSE

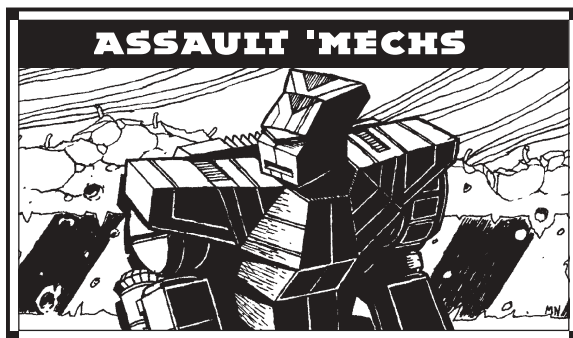

ASSAULT 'MECHS

Mass: 80 tons
Chassis: Wells 990
Power Plant: LTV 400
Cruising Speed: 54 kph
Maximum Speed: 86 kph
Jump Jets: None
Jump Capacity: None
Armor: Durallex Heavy
Armament:
 5 Magna Mark I Light Lasers
Manufacturer: Luthien Armor Works
Primary Factory: Luthien
Communications System: Tek BattleCom
Targeting and Tracking System: Dalban Hirez

Overview

Question: What's a Lyran's favorite recon unit?
 Answer: A *Charger* in enemy hands.

The answer to that tired joke refers to Luthien Armor Work's biggest failure, the CGR-1A1 *Charger*. Initially conceived as an ultra-heavy recon element for the SLDF, most Combine warriors see a *Charger* assignment as punishment duty.

The *Charger* was produced by Wells Technologies, a former LAW licensee. Wells Tech closed its doors in 3027 after a major LAW buyout; the CGR-1A1 lines slowed to a trickle shortly afterwards and ceased altogether in 3030.

Capabilities

While the *Charger's* popgun laser array is laughable even to MechWarrior wannabes, its solid Durallex Heavy

armor is not. Sporting ten tons of armor, the *Charger* can easily endure brushes with medium and heavy 'Mechs. Considering the *Charger's* weak offensive firepower, it needs all the time and protection its armor can provide. Sturdy as it is, the armor will not withstand sustained abuse, and *Charger* pilots are often reminded to stay out of heavy combat.

Originally intended as a high-speed recon 'Mech that sported false weapon mounts (along the lines of the *Chameleon* 'Mech trainers), the design utterly failed. With the onset on the Succession Wars, the *Charger* became a reliable, low-maintenance 'Mech, which irked LAW profiteers to no end. It was effective on Periphery border worlds, defending against swarms of *Stingers*, *Wasps*, and any 'Mechs whose main armament was already destroyed.

Deployment

Because the design was withdrawn from SLDF use, Wells Tech found itself practically wallowing in *Chargers* due to inflated sales projections and resultant overproduction. The fall of the Star League and the First Succession War, oddly enough, saved the company from bankruptcy. Needing whatever 'Mechs it could find, the DCMS bought the company's overstock and established a long-term contract to support its rapid expansion. Thus, most *Chargers* are found in DCMS forces.

Inevitably, battlefield salvage distributed *Chargers* into the militaries of the LAAF and AFFS, and to a lesser extent, the FWLM. Davion forces ended up moving the salvage to the mercenary market, while Lyran forces adopted the design as a heavy recon element for its assault companies. Though the Lyrans embraced the *Charger* somewhat more warmly than other Houses, Wells could not actively sell the design to them due to export restrictions. Other avenues were explored; when the ISF finally uncovered the long-running operation, LAW executed an emergency buy-out and invited the Wells Tech corporate board to "dine with their ancestors."

Variants

Only two variants made an appearance in the early part of the 31st century. The CGR-1L was sold to the Capellans by Wells Tech via trade articles of the

Kapteyn Accords. It replaced the small lasers with two mediums and a large laser at the cost of nearly half its armor protection. Considering the desperate mindset of CCAF warriors, however, it was an acceptable variant to the Capellans. The CGR-1A5 variant was a Capellan modification. The engine is downgraded, freeing up enough space to fit an autocannon/20, twin SRM 6 racks, and a medium laser, turning the *Charger* into a fearsome short-ranged brawler.

The DCMS deemed the CGR-1A1 *Charger* a lost cause and formed an advisory board with LAW to redesign the platform. The board initially put the idled *Charger* line to work on the up-gunned, slower CGR-1A9 (mounting one small and four medium lasers and an LRM 20) that so surprised AFFS forces in the War of 3039. Later, the military aid from ComStar gave the DCMS a windfall of advanced technology that, among other things, led to the *Charger*-derived *Hatamoto-Chi*.

Notable MechWarrior

MechWarrior Terry Ford: Once considered the luckiest MechWarrior in the Successor States, Ford piloted the "*Number Seven*" up until his rather unlucky death during a raid with the Ninth Illician Rangers. Notorious for surviving hits that would've destroyed *Atlases* and *Banshees* in droves, Ford refused to allow anyone to repair his 'Mech aside from himself and an astech. The Seven was upgraded numerous times but never performed at optimal efficiency—partly due to Ford's meager technical skills. The Seven's luck finally ran out when Ford leapt off an embankment intent on giving a Sorenson's Sabres *Longbow* a "Highlander Burial." Instead, the gyro overreacted to the freefall and Ford managed to send the Seven into a tremendous face plant that took his life.

The Seven was claimed as salvage by the Sabres but despite a complete rebuild, it was plagued incessantly with constant glitches, malfunctions, and errors. The Seven eventually disappeared from the Sabres' roster—one rumor has the pilot-less Seven "accidentally" falling out of a DropShip during a combat drop drill.

CGR-1A1 CHARGER

Type: **Charger**

Technology Base: Inner Sphere

Tonnage: 80

Battle Value: 981

Equipment

Internal Structure:

Engine: 400

Walking MP: 5

Running MP: 8

Jumping MP: 0

Heat Sinks: 10

Gyro: 4

Cockpit: 3

Armor Factor: 160

Mass

8

52.5

0

4

3

10

	Internal Structure	Armor Value
--	--------------------	-------------

Head	3	9
------	---	---

Center Torso	25	25
--------------	----	----

Center Torso (rear)		6
---------------------	--	---

R/L Torso	17	20
-----------	----	----

R/L Torso (rear)		5
------------------	--	---

R/L Arm	13	15
---------	----	----

R/L Leg	17	20
---------	----	----

Weapons

and Ammo

	Location	Critical	Tonnage
Small Laser	H	1	.5
Small Laser	RT	1	.5
Small Laser	RA	1	.5
Small Laser	LT	1	.5
Small Laser	LA	1	.5

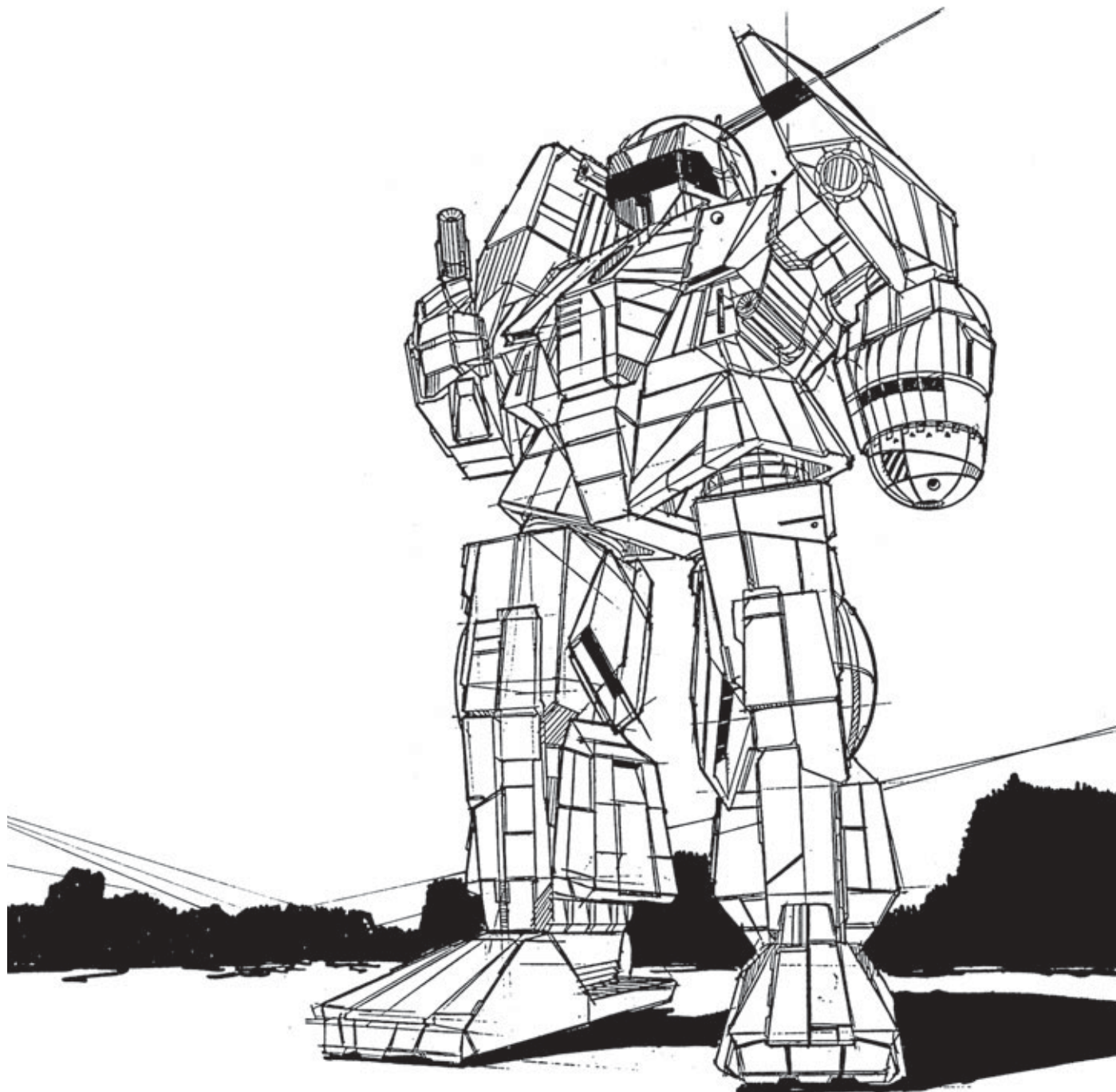

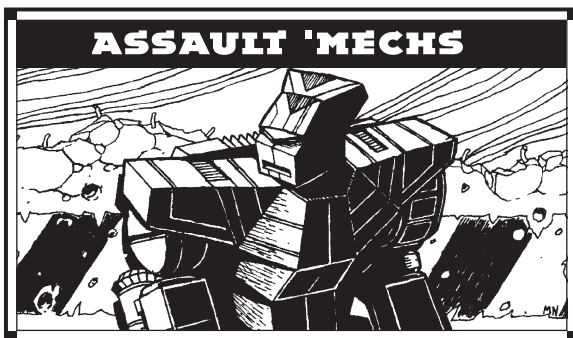

Mass: 80 tons
Chassis: HildCo Type V
Power Plant: Pitban 340
Cruising Speed: 43 kph
Maximum Speed: 64 kph
Jump Jets: HildCo Model 12
Jump Capacity: 120 meters
Armor: Durallex Heavy
Armament:
 1 Pontiac 100 Autocannon/20
 2 Sorenstein V Medium Lasers
 1 Holly Short Range Missile Pack (4)
Manufacturer: HildCo Interplanetary,
 Independence Weaponry
Primary Factory: St. Ives (HildCo),
 Quentin (Independence)
Communications System: Opus III Highbeam
Targeting and Tracking System: MaLandry 34

Overview

The VTR-9B *Victor* was originally built under a defense contract with the Terran Hegemony in 2510. Conceived of as a support 'Mech with jump capabilities, the *Victor* went on to serve the SLDF in the bloody Reunification War, and the design was later made available to the League's member states.

Capabilities

Unlike many assault 'Mechs, the *Victor* has jump capability. Inexperienced MechWarriors do not expect such a large 'Mech to be able to jump, and that can spell their doom when they encounter a *Victor*.

The Pontiac 100 autocannon provides the *Victor* with massive firepower, and although some models have reported ammunition feed problems, this does not appear to be common. The *Victor's* left arm sports the mainstay of its close range weapons, the twin Sorenstein V medium lasers. These lasers are supplemented by a Holly short-range missile rack for close-range fire support.

The *Victor* was originally outfitted with a Standus 20 tracking system, but it was replaced due to its tendency to project targets that did not exist.

Deployment

The destruction of all three HildCo Interplanetary *Victor* production lines left only Independence Weaponry capable of manufacturing the BattleMech. As a result, the bulk of *Victors* are to be found in the Federated Suns, where they remain one of the AFFS's primary assault 'Mechs and a popular mount for battalion and regimental commanders. Consequently, the loss of the planet Quentin and Independence Weaponry is a major concern. This loss forced the Federated Suns to buy *Victors* from the rebuilt HildCo Interplanetary plant situated in the St. Ives Compact.

Davion's Avalon Hussars used their *Victors* advantageously against House Liao during the Second Succession War. With their jump capability, the *Victors* proved to be more dangerous fighting in the mountains of Wei and Redfield than more heavily armed and armored assault 'Mechs. Several Hussar pilots and officers still use the *Victor*.

The Avalon Hussars' *Victors* later engaged Liao 'Mechs on the planet Wright in 3012. A Hussar attack lance consisting of several *Victors* encountered two recon lances of light 'Mechs. The *Victors'* jump attacks and autocannons reduced the two lances to rubble in a matter of minutes.

Although the Draconis Combine now has access to a supply of new *Victors*, they deploy them sparingly. Many proud Kuritan samurai refuse to pilot a design so closely associated with their traditional enemy.

In the breakaway St. Ives Compact, the St. Ives Lancers use the *Victor* as the core of their heavy lances.

Variants

Used by SLDF's line regiments, the *Victor* was never outfitted with the advanced Terran Hegemony technology

reserved for the Royal units—a fact that allowed this more primitive BattleMech to be maintained through the Succession Wars.

Several earlier VTR-9As have surfaced in recent years, units armed with a sophisticated array of anti-infantry weaponry systems. Few of this version were built since technicians felt that the *Victor's* role as a support 'Mech would keep it from engaging infantry, and so the two flamers and machine gun were replaced with armor in the 9B.

A unique example of a modified *Victor* supporting a Holly SRM 6 rack also appeared within the Lyran Commonwealth during the Third Succession War.

Notable MechWarriors

Lieutenant Ramsey Donal: Currently, Lieutenant Donal is working for the Twelfth Vegan Rangers in the attack lance. His 'Mech is in fair condition, but his Holly missile rack has had firing difficulties ever since he tangled with a Kuritan *Warhammer* at close range on the planet Tripoli.

Captain Debbie Malgur: This competent MechWarrior is currently employed by Helmar Valasek, who gave her command of a heavy recon lance. Her *Victor* is a 9A variety. Her history and her method of acquiring this rare 'Mech are unknown, but her skill is reputed to be excellent.

Field Marshal Ardan Sortek: A childhood friend of Hanse "the Fox" Davion, Sortek is also a trusted member of the First Prince's inner circle. A skilled and cunning warrior, Sortek coaxes top performance from his *Victor*—often surprising an opponent with the assault 'Mech's jump capability.

During the liberation of Stein's Folly in 3025, Sortek's autocannon became clogged with mud and jammed. Though deprived of most of his firepower, Sortek still aided in dispatching two Liao heavy BattleMechs—one with a daring death from above attack.

While touring the Lyran Commonwealth in 3027, Sortek fought beside the Kell Hounds against elements of the Second Sword of Light. His one-on-one duel with a Kurita *Awesome* was a textbook example of mobility over raw firepower.

VTR-9B VICTOR

Type: **Victor**

Technology Base: Inner Sphere

Tonnage: 80

Battle Value: 1,370

Equipment

Internal Structure:

Engine: 320 **Mass** 8

Walking MP: 4 22.5

Running MP: 6

Jumping MP: 4

Heat Sinks: 15 5

Gyro: 4

Cockpit: 3

Armor Factor: 184 11.5

	<i>Internal Structure</i>	<i>Armor Value</i>
--	---------------------------	--------------------

Head	3	9
------	---	---

Center Torso	25	30
--------------	----	----

Center Torso (rear)		15
---------------------	--	----

R/L Torso	17	20
-----------	----	----

R/L Torso (rear)		10
------------------	--	----

R/L Arm	13	15
---------	----	----

R/L Leg	17	20
---------	----	----

Weapons

and Ammo

	Location	Critical	Tonnage
--	-----------------	-----------------	----------------

AC/20	RA	10	14
-------	----	----	----

Ammo (AC) 15	RT	3	3
--------------	----	---	---

2 Medium Lasers	LA	2	2
-----------------	----	---	---

SRM 4	LT	1	2
-------	----	---	---

Ammo (SRM) 25	LT	1	1
---------------	----	---	---

Jump Jets	CT	2	2
-----------	----	---	---

Jump Jet	RL	1	1
----------	----	---	---

Jump Jet	LL	1	1
----------	----	---	---

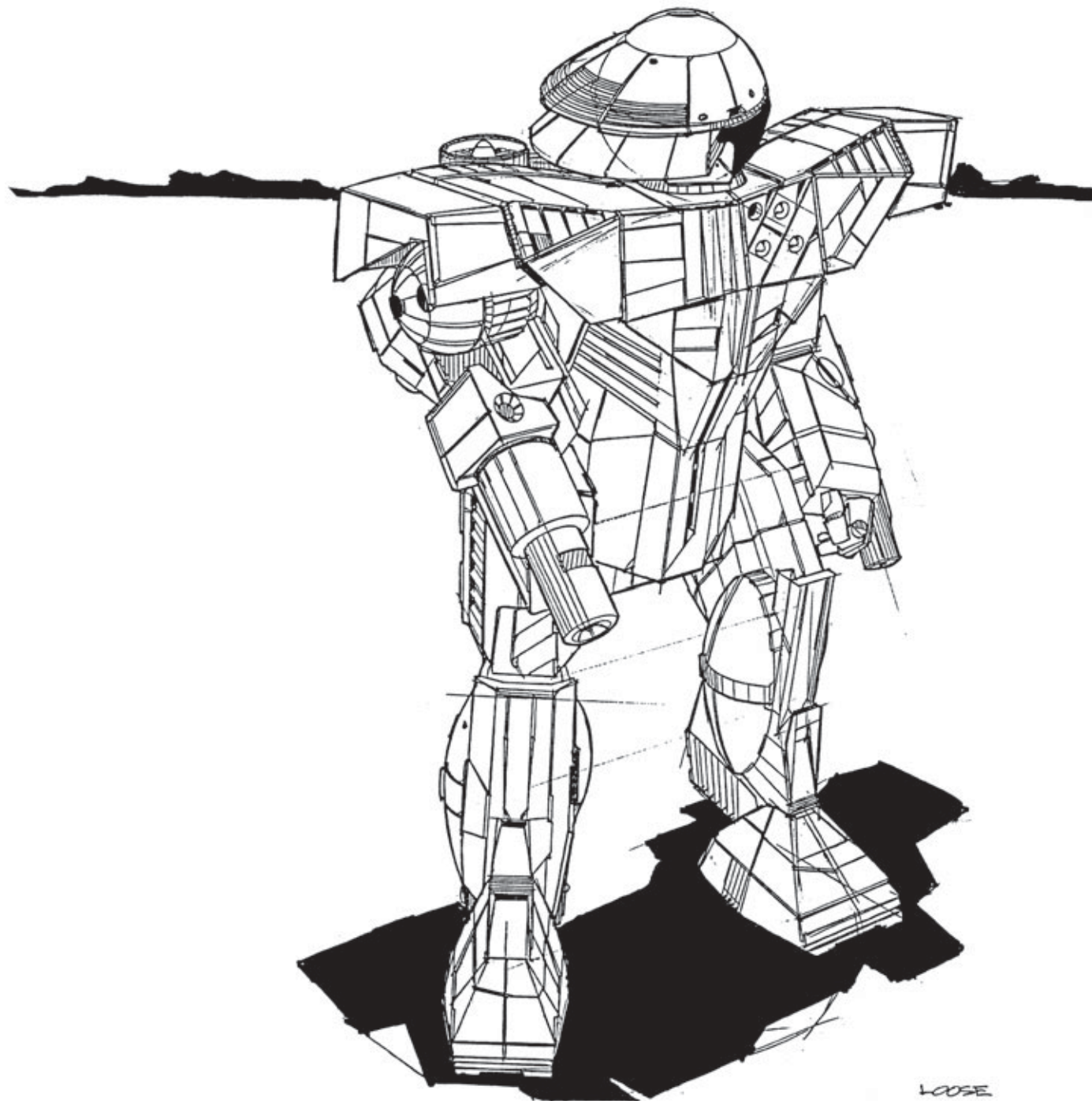

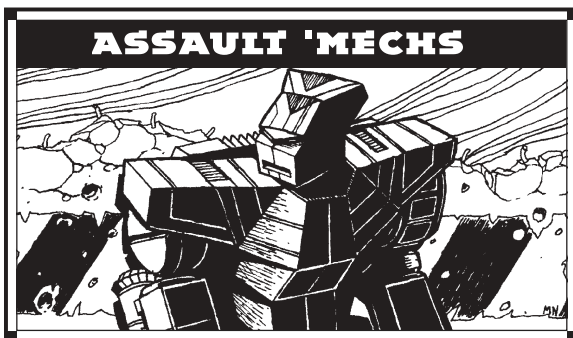

Mass: 80 tons

Chassis: Chariot Type III

Power Plant: Pitban 320

Cruising Speed: 43 kph

Maximum Speed: 64 kph

Jump Jets: None

Jump Capacity: None

Armor: Valiant Lamellor

Armament:

- 1 Thunderbolt A5M Large Laser
- 1 Coventry Star Fire LRM Missile System
- 1 Defiance Class 5 Autocannon
- 2 Defiance B3M Medium Lasers

Manufacturer: Defiance Industries

Primary Factory: Hesperus II

Communications System: TharHes Calliope ZE-2

Targeting and Tracking System: TharHes Ares-7

Overview

With the Star League disbanded in 2781, the stability of the past two centuries passed and the status quo started to change dramatically. Seeking to be prepared for this new political reality, the Lyran Commonwealth began work on a new light-assault 'Mech to bolster its forces. The first *Zeus* walked off the line in 2787, just in time for the First Succession War.

Capabilities

The *Zeus* is built around a sturdy frame and reliable engine. While other 'Mechs designed in the same era used

advanced technology, the *Zeus* stuck with reliable, roomy systems that allowed easy repair and modification. This paid off in the long run, for as advanced weapons, heat sinks, and armor became unavailable, the *Zeus* could still be manufactured with less advanced components without drastically changing the design.

At 64 kph, the *Zeus* can keep up with the heavy 'Mechs that make up the backbone of BattleMech units around the Inner Sphere. With over eleven tons of armor and a wide range of weapons, it can fight with them as well. The LRM and autocannon provide good ranged firepower with low heat. When closing, the large laser can add to that, and a medium laser aids at short ranges where the missiles are inaccurate. For rear defense, another medium laser wards off fast units. When the enemy gets close, the *Zeus*' LRM launcher is of little use but the arm is not. By setting the launcher and tubes back in the arm around a heavy punching core, a *Zeus* pilot can bludgeon the enemy away without fear of damaging the weapon.

The original design was more advanced, having upgraded versions of the large laser and a targeting system for the LRM launcher along with advanced heat sinks and armor. However, most striking was that it mounted a PPC in the left arm. Due to magnetic interactions between the engine and PPC, the PPC was later replaced by an autocannon.

Some pilots complain of the limited amount of ammunition for the LRM, but others retort that by the time the *Zeus* is out of missiles, it's probably running low on armor and an empty bin is safer when the armor fails. Pilots also disagree on the *Zeus*' heat sinks, noting that unless every weapon is fired, a pristine *Zeus* can't build up heat. Some favor this, while others would rather ride the heat curve and have more armor.

Deployment

The *Zeus* can be found in almost any unit arising from the Lyran Commonwealth and many other Federated Commonwealth forces. The *Zeus* has been sold to many different mercenary units; Wolf's Dragoons' Zeta Battalion has nothing but praise for the 'Mech. Former Davion units have not taken to the *Zeus* due to "Davion pride," relegating

it to militia or reserve duty despite its superiority to some of the Davion designs that take its place at the front.

The *Zeus* didn't even make it out of the prototype stage before being tested in combat. The Draconis Combine raided Hesperus II at the onset of the First Succession War. After a few lances broke through the Lyran lines, the prototypes were called up to assist. While the *Zeus*' PPCs rarely hit the enemy, the sheer firepower they were pouring out at long range forced the Kuritan units to pause, having never seen the design before. This bought enough time to allow front-line units to push the Combine forces back.

Variants

The advanced forebears to the current *Zeus*, the 5S and 5T, are long gone, having been downgraded to the 6S model due to damage and lack of parts, if they have survived at all. Advancements after the Third Succession War led to the ability to replace the autocannon with a PPC as originally designed. The resulting ZEU-6T was the new standard model and performed well in the Fourth Succession War and War of 3039 before being overtaken by further technological improvements.

Notable MechWarriors

MechWarrior Sealth: After his homeworld of Zavijava was attacked, Sealth left a conclave of people all descended from Native North Americans to join the Tenth Skye Rangers to help defend his people. An amazingly graceful MechWarrior, Sealth could move his *Zeus* as if it were a 'Mech half its weight, making it a difficult target. In the Fourth Succession War he would flank formations, hitting and dodging. While the enemy was distracted by him, the rest of his unit would hit the enemy head on. After the fighting ended, Sealth retired back to Zavijava, taking his forest-green *Zeus*, Skokomish, with him.

ZEU-6S ZEUS

Type: **Zeus**

Technology Base: Inner Sphere

Tonnage: 80

Battle Value: 1,348

Equipment

Internal Structure:

Engine:

Walking MP:

Running MP:

Jumping MP:

Heat Sinks:

Gyro:

Cockpit:

Armor Factor:

Mass

8

22.5

320

4

6

0

17

7

4

3

11.5

	Internal Structure	Armor Value
--	--------------------	-------------

Head

3

9

Center Torso

25

26

Center Torso (rear)

9

R/L Torso

17

18

R/L Torso (rear)

6

R/L Arm

13

22

R/L Leg

17

24

Weapons

and Ammo

LRM 15

Location

Critical

Tonnage

RA

3

7

Ammo (LRM) 8

RT

1

1

AC/5

LA

4

8

Ammo (AC) 20

LA

1

1

Large Laser

LT

2

5

Medium Laser

LT (R)

1

1

Medium Laser

CT

1

1

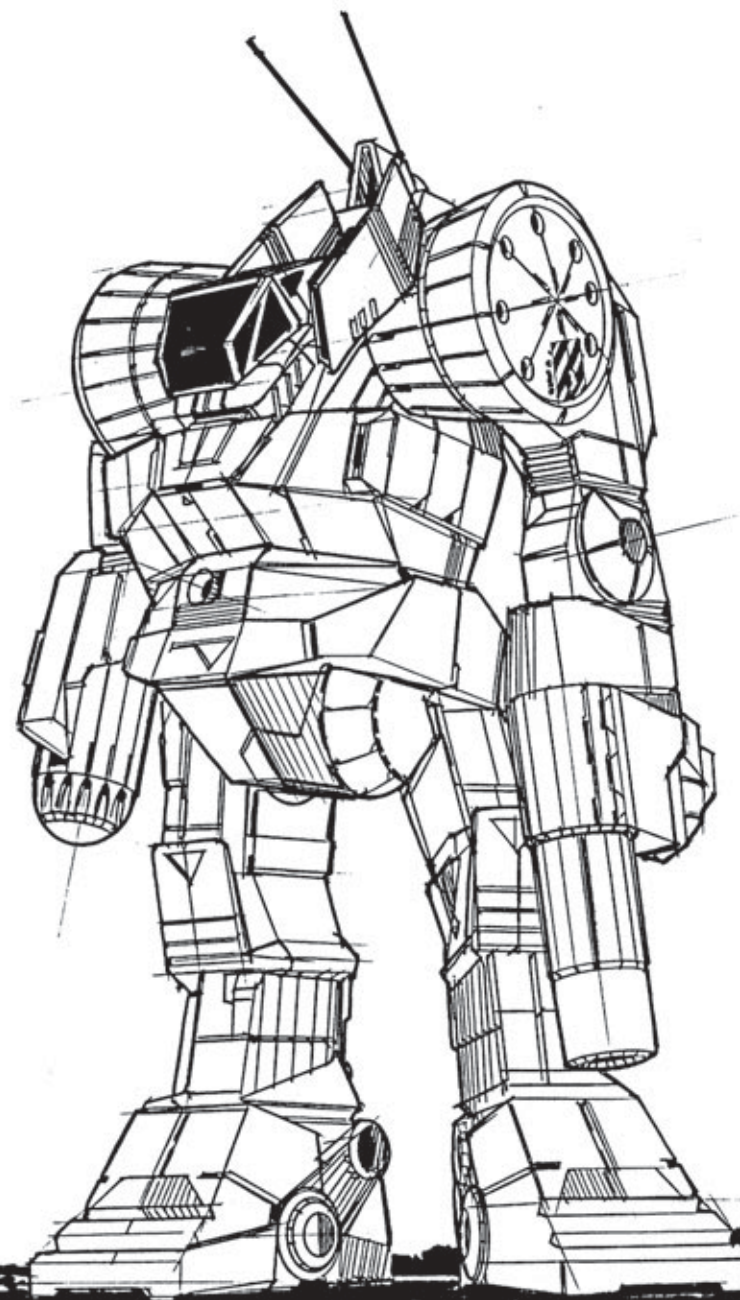

LOOSE

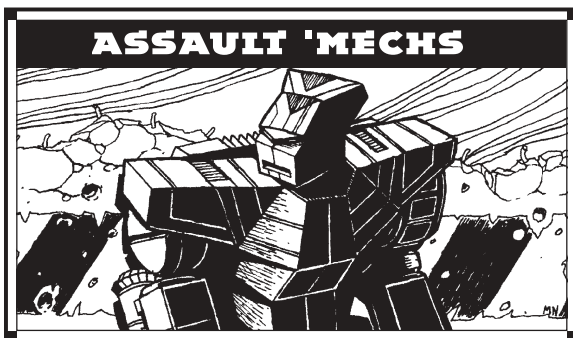

Mass: 85 tons

Chassis: Titan H1

Power Plant: Strand 255

Cruising Speed: 32 kph

Maximum Speed: 54 kph

Jump Jets: None

Jump Capacity: None

Armor: Valiant Lamellor

Armament:

2 Jackson B5c LRM 10

2 Magna Mark III Large Lasers

4 Magna Mark II Medium Lasers

2 Thunderstroke SRM 6

Manufacturer: Irian BattleMechs Unlimited,
Trellshire Heavy Industries

Primary Factory: Shiro III (Irian),
Twycross (Trellshire)

Communications System: Cronol PR

Targeting and Tracking System: Spar 3c Tight Band

Overview

Although it doesn't get a large portion of the lime-light in the media that other high-profile BattleMechs receive, the *Stalker* has been the workhorse assault 'Mech of most Successor State militaries for more than two hundred years and served the SLDF for two centuries prior to that. Designed by Triad Technologies in 2594, the *Stalker* is a powerhouse of a 'Mech, mounting a mix of heavy weaponry and heavy armor. While no one will ever accuse the *Stalker* of being fast, few can claim it is easy to stop.

Capabilities

The simplest description of the *Stalker* BattleMech is that it's a brute. At 85 tons it sits comfortably in the middle of the assault 'Mech classification. A 255-rated Strand fusion engine provides power for movement and weaponry, and while it's not fast, the *Stalker's* 54 kph top speed lets it keep up with other assault elements. Thirteen-and-a-half tons of Valiant Lamellor armor keep the *Stalker* in the battle, and twenty heat sinks make heat management easy.

The *Stalker's* armament is varied and crosses most common range bands. A pair of Jackson LRM 10 racks provides long-range bombardment capabilities, while a matched set of Magna Mark III lasers offer powerful middle-range firepower. Once the *Stalker* closes with its enemy, a bank of four Mark II medium lasers support a pair of Thunderstroke SRM 6 launchers. The *Stalker's* only concession to limitations is the need for a staggered firing pattern, employing either the lasers and the Jacksons or the Mark IIs and the Thunderstrokes. MechWarriors who try a so-called "alpha strike" on their opponents find themselves in heat-overload, praying their stored missile reloads don't explode. The *Stalker's* original manufacturer, Triad Technologies, had a simple marketing slogan for this 'Mech: "It's not flashy. It's not the cutting edge. It just keeps coming."

Deployment

In continuous production for over four hundred years, the *Stalker* has a prominent place in the heavy lances of every Successor State and Periphery nation. It is also favored by scores of mercenary units. The Free Worlds League and Lyran Commonwealth hold a small advantage in raw numbers, with several factories producing the 'Mech. It is also a popular 'Mech in the dueling circuits of Solaris VII.

Wherever the *Stalker* is found it is ignored, except when faced in combat. The dichotomy is ironic; only when faced with one will MechWarriors admit to fear of it. Otherwise the *Stalker* is just too common to make a good bogeyman.

Variants

With such a storied career, variants of the *Stalker* are almost as numerous as the 'Mech itself. Before its destruction Triad Technologies introduced one other variant that was designed for siege work. The STK-3H removes the large lasers and upgrades the Jackson launchers to twenty-racks. There are other variants that try to lighten the strain on the 'Mech's legs because of age or damage, but they can only do so by removing weaponry.

Notable MechWarriors

Colonel J. Elliot Jamison: Commander of Zeta Battalion of Wolf's Dragoons, easily the most popular and feared assault battalion in the Inner Sphere, Colonel Jamison believes in leading from the front. His *Stalker* was heavily scarred but functioned perfectly, thanks to the Dragoons' impressive technical staff. Despite the battering Zeta Battalion has gone through, Jameson never lost any of his fire. The longest-serving commander of Zeta Battalion (all the previous Zeta colonels have died in the course of their duties), he resisted moving any higher in the Dragoons' organization, instead preferring to stay with what he knows (and does) best.

Captain Hubert Glass: Captain Glass leads an assault company in the Fifth Marik Militia. During an engagement against Liao raiders on Les Halles in 3039, Glass and his company were separated from the rest of the battalion and then surrounded by two companies of Liao *Vindicators* and *Cataphracts*. Captain Glass, after listening to the Liao commander's harangue about surrender, stood on his cockpit couch, cracked his egress hatch, and made a rude gesture to the Liao commander's *Cataphract*. While the rest of his company attacked, he calmly sat down, sealed his hatch, and buckled in. So furious was the Militia company's fire that the Liao commander was disabled before he could fire on Glass' *Stalker*. In ten hectic minutes of combat the assault company annihilated the two Liao companies to a 'Mech, losing only five of their own.

STK-3F STALKER

Type: **Stalker**

Technology Base: Inner Sphere

Tonnage: 85

Battle Value: 1,559

Equipment

		Mass
Internal Structure:		8.5
Engine:	255	13
Walking MP:	3	
Running MP:	5	
Jumping MP:	0	
Heat Sinks:	20	10
Gyro:		3
Cockpit:		3
Armor Factor:	216	13.5

	Internal Structure	Armor Value
Head	3	9
Center Torso	27	36
Center Torso (rear)		11
R/L Torso	18	25
R/L Torso (rear)		7
R/L Arm	14	23
R/L Leg	18	25

Weapons and Ammo

	Location	Critical	Tonnage
LRM 10	RA	2	5
Ammo (LRM) 12	RA	1	1
LRM 10	LA	2	5
Ammo (LRM) 12	LA	1	1
Large Laser	RT	2	5
Large Laser	LT	2	5
2 Medium Lasers	RA	2	2
2 Medium Lasers	LA	2	2
SRM 6	RT	2	3
Ammo (SRM) 15	RT	1	1
SRM 6	LT	2	3
Ammo (SRM) 15	LT	1	1

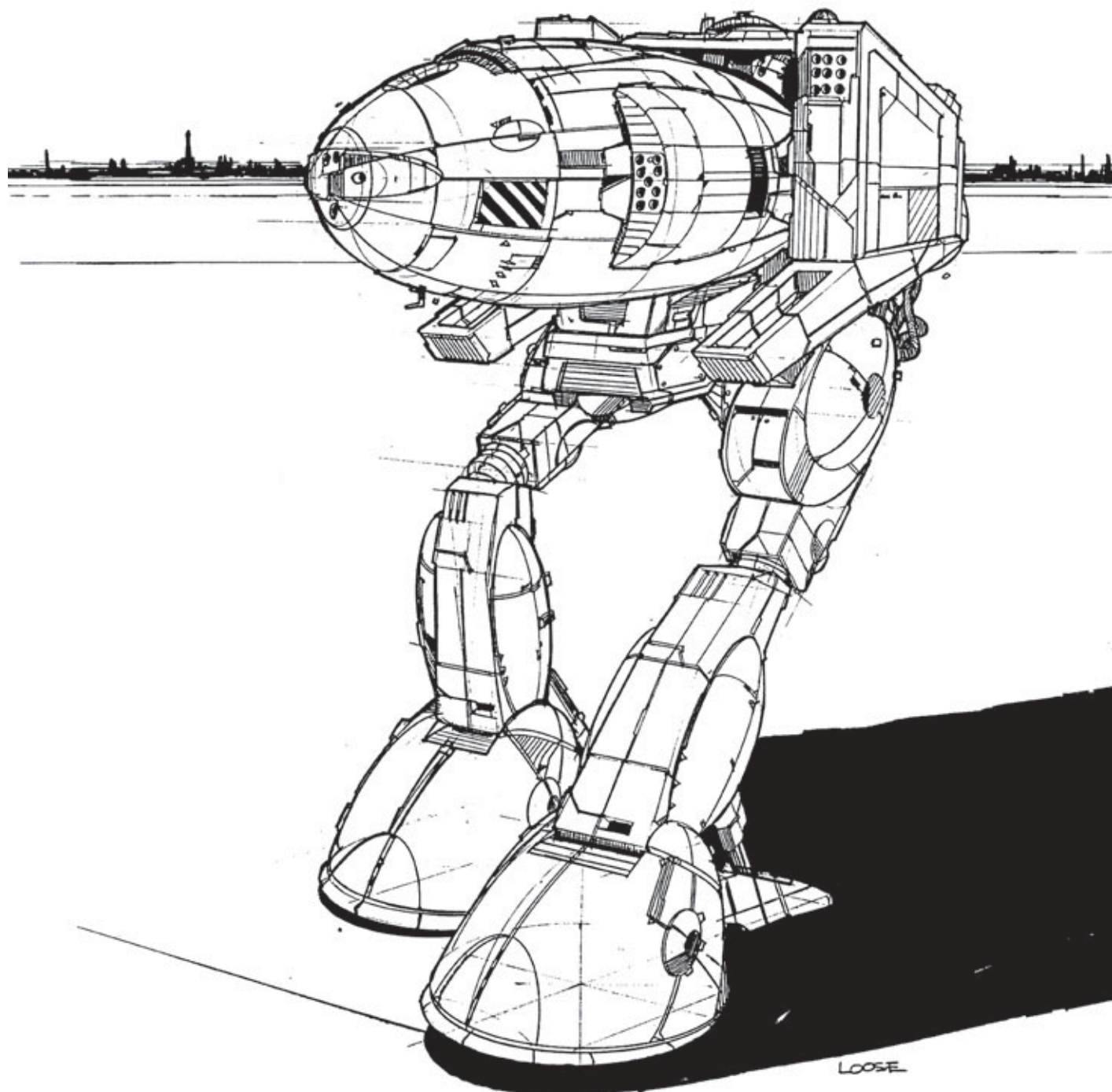

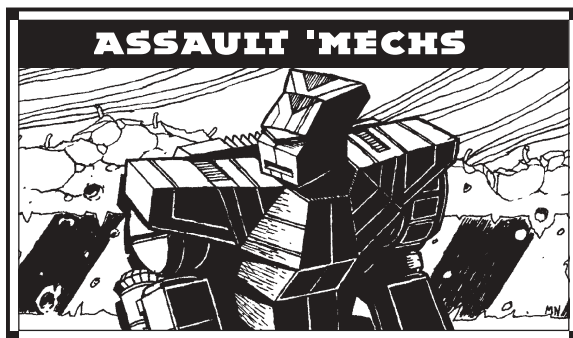

Mass: 90 tons

Chassis: Stormvanger HV-7

Power Plant: Hermes 360

Cruising Speed: 43 kph

Maximum Speed: 64 kph

Jump Jets: None

Jump Capacity: None

Armor: Starshield Special

Armament:

- 2 Diverse Optics Type 20 Medium Lasers
- 1 Delta Dart Long Range Missile 10-Rack
- 1 Hovertec Short Range Missile Quad
- 1 Zeus-36 Mark III Autocannon

Manufacturer: Stormvanger Assemblies, Unlimited

Primary Factory: Caph (destroyed 2774)

Communications System: Olmstead 840

Targeting and Tracking System: Tacticon Tracer 280

Overview

The SLDF requested an assault platform able to perform in swift, mobile offensives assisting the commanders of its Regular army units. Engineers eventually debuted the *Cyclops* in 2710 and designed it to be part of a command unit. Unfortunately the *Cyclops* suffers from the mindset that the BattleMech would have ample supplies and supporting units at its disposal. No one expected the carnage of the Succession Wars and the extent that it would strip the military's capabilities to support its BattleMech regiments.

Capabilities

When taking the original expectations into consideration, the *Cyclops* is a good platform, able to keep up with most mobile campaigns thanks to its sizeable Hermes 360 engine. Ten tons of armor keep the design protected enough until reinforcements arrive to drive off would-be headhunter units, and a single LRM rack allows it to support its comrades as it pulls back. For up-close engagements, a Zeus-36 Mark III is a feared gun, forcing opponents to gang up on the command machine to have a chance, while two medium lasers and a back-up SRM 4 pack prevent smaller swarm units from gaining the advantage early on. Twelve heat sinks give the *Cyclops* an acceptable ability to stay cool, though those under heavy fire find out "acceptable" is a relative term.

The key feature of a *Cyclops* is not its weaponry or speed, but something that had no direct effect on combat: its Tacticon B-2000 Battle Computer, which allows MechWarriors to coordinate a full brigade. The highly capable Olmstead 840 communications system allows the B-2000 to monitor brigade activities anywhere on a planet. The ability to coordinate while in the safe confines of a BattleMech cockpit is understandably popular among officers.

Deployment

Due to a lack of spare parts, many B-2000s broke down over the centuries. Only ten percent of the active *Cyclops* are estimated to have a working system, making them highly prized by high-ranking officers. The rest serve as swift, if mediocre, assault platforms, either as bodyguards to the CO, or decoys, drawing enemy fire away from the important officers.

Variants

Due to not seeing much combat, few variants have appeared throughout the years. The most notable—the CP-10-HQ—fits the *Cyclops* with a Collapsible Command Vehicle Module mounted on the rear torso in place of the autocannon. The CCVM could be dismounted and set up in the field within fifteen minutes, establishing a fully operational headquarters bunker. Many were damaged beyond repair during the Succession Wars or attached to makeshift

command vehicles. Among those *Cyclops* with a working B-2000, less than half have a working CCVM.

Another variant, the CP-10-Q, replaces the autocannon with another LRM 10 launcher and medium laser. Three additional tons of ammunition allow the *Cyclops* to support its brethren from afar.

Other versions carry false head protectors, which pilots thought would give slightly more protection against missiles and projectiles impacting against the 'Mech's exposed head. Shortly after the Fourth Succession War, a Federated Suns think tank did a study on this theory, originally proposing to outfit all remaining BattleMechs with such a cheap and low-tech add on. The study determined, however, that the head protectors actually caused more damage by restricting a MechWarrior's vision, and they created extra shrapnel when hit with weapons fire. The proposal was dropped, and many *Cyclops* pilots quickly took off the "helmets."

[EDITOR'S NOTE: With the discovery of the Helm core, attempts were made to reproduce the B-2000 Battle Computers. No notable successes occurred before the Clan Invasion, and the invention of C3 systems for smaller-scale engagements coupled with the doctrinal change of using more secure DropShips for command posts made many lose interest in the B-2000. In campaigns where a B-2000 is present, though, its effects were still very noticeable.]

Notable MechWarriors

Major Wolfgang Hansen: Piloting one of the two *Cyclops* with a working B-2000 in the mercenary regiment Hansen's Roughriders (the other one being used by his father, Colonel Gerhardt Hansen), Major Hansen was slated to take command of the unit once the War of 3039 was concluded. However, his relatively poor performance against the Fifth Sword of Light on Pike IV while defending the city of Mercator (which some attributed to his concerns over his wife who at the time was giving birth to their first child on Algol) has convinced his father to retain command for a few more years while putting Wolfgang through an extremely rigorous training regime to ensure a high level of quality when he finally retires.

CP-10-Z CYCLOPS

Type: **Cyclops**

Technology Base: Inner Sphere

Tonnage: 90

Battle Value: 1,308

Equipment

		Mass
Internal Structure:		9
Engine:	360	33
Walking MP:	4	
Running MP:	6	
Jumping MP:	0	
Heat Sinks:	12	2
Gyro:		4
Cockpit:		3
Armor Factor:	160	10

	<i>Internal Structure</i>	<i>Armor Value</i>
Head	3	9
Center Torso	29	30
Center Torso (rear)		11
R/L Torso	19	20
R/L Torso (rear)		8
R/L Arm	15	10
R/L Leg	19	17

Weapons

and Ammo	Location	Critical	Tonnage
AC/20	RT	10	14
Ammo (AC) 10	RT	2	2
Ammo (AC) 10	LT	2	2
LRM 10	LT	2	5
Ammo (LRM) 12	LT	1	1
Medium Laser	RA	1	1
Medium Laser	LA	1	1
SRM 4	CT	1	2
Ammo (SRM) 25	CT	1	1

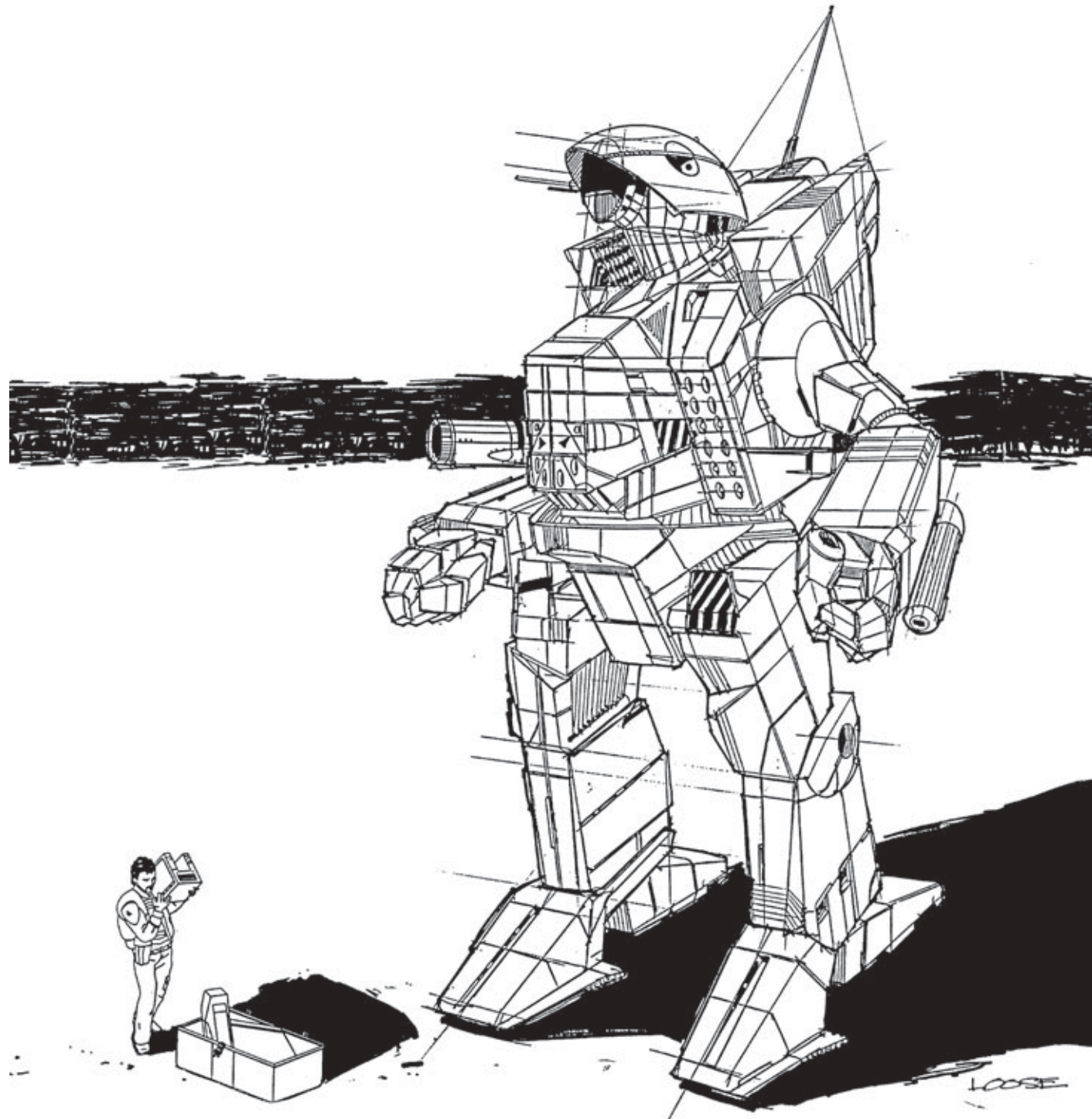

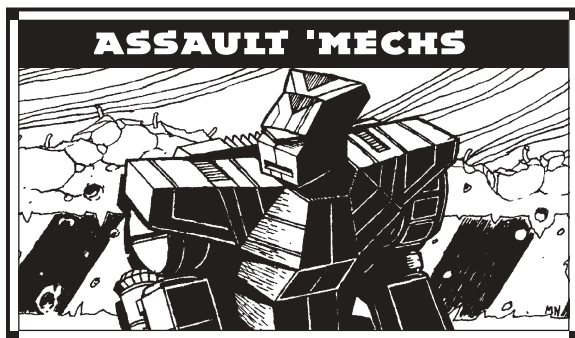

Mass: 95 tons

Chassis: Star League XT

Power Plant: GM 380

Cruising Speed: 43 kph

Maximum Speed: 64 kph

Jump Jets: None

Jump Capacity: None

Armor: Starshield

Armament:

1 Magna Hellstar PPC

1 Imperator-A Autocannon

1 Magna Mark I Small Laser

Manufacturer: Defiance Industries

Primary Factory: Hesperus II

Communications System: Dalban Commline

Targeting and Tracking System: Dalban HiRez-B

Overview

An early BattleMech design, the *Banshee* was built with the cutting-edge military technology of its time. Taken as a whole, however, the design fell short. The *Banshee* was intended as a close assault 'Mech, but critics claimed and battlefield results showed that privately designed 'Mechs outclassed its firepower. Despite this, the Hegemony built five thousand *Banshees* in just a decade before ceasing production. The *Banshee's* poor performance soon relegated it to militia and training units, where over a third of the units survived to the thirty-first century, when Defiance opened a *Banshee* line.

Capabilities

The *Banshee* is undeniably fast for such a large 'Mech, but beyond that its abilities are debatable. Fifteen tons of Starshield armor gives the 'Mech ample protection, but armor alone can't take down one's enemies. A PPC and medium autocannon give the *Banshee* good firepower—if it were a medium 'Mech. But even if the *Banshee* gets close enough to bring its mass into play, its main weapon's minimum ranges make targeting difficult, and the head-mounted small laser does little to mitigate the situation.

Fighting the Sixth Arkab Legion on Buckminster during the Fourth Succession War, the Twentieth Arcturan Guards tried to prevent the Legion from linking up with the Second Sword of Light. Having never fought a BNC-3S, the Kuritans ignored the *Banshees* to concentrate on the Lyran *Zeuses* and *Archers*. The *Banshees* fired just one PPC as they approached until they were a third of kilometer from the enemy forces, where they unleashed their full might. Unable to withstand the fire power of the massive 'Mechs, the Arkab forces pulled back and closed ranks. This eliminated their advantage of mobility and allowed elements of the Third Royal Guards to arrive and force the Arkab Legion to withdraw.

Deployment

BNC-3E *Banshees* can usually be found in reserve, militia, or poorly outfitted units throughout the Inner Sphere and Periphery, with a few brave or unlucky MechWarriors piloting them in premier units. The greatest concentration is found in the Lyran Commonwealth, where Defiance is actually producing the *Banshee* once more. The Lyrans are even assigning their new BNC-3S *Banshees* to the front line.

Variants

House Marik was the first to really tinker with the *Banshee*. The BNC-3M replaces the autocannon with a PPC and a pair of medium lasers. However, a lack of PPCs has led to a further upgrade—the BNC-3Q—which removes the PPC and upgrades the autocannon to a massive KaliYama class 20. The Magistracy of Canopus has recently remodeled their *Banshees* by removing heat sinks to upgrade the autocannon to an Imperator-B.

While none of those changes have allowed the *Banshee* to rise above mediocrity, House Steiner's BNC-3S has risen to greatness. By replacing the GM 380 with a Pitban 285, tonnage was freed up to upgrade the autocannon to an Imperator-B while mounting a second small laser and PPC, and adding four medium lasers plus an SRM 6 rack. The armor was not modified, but five additional heat sinks were installed.

Notable MechWarriors

General Jeren Reinesblatt: Despite graduating from the respected Nagelring, Reinesblatt lacked the social contacts to rise through the Lyran ranks and left for the Periphery full of bitterness. He found numerous like-minded MechWarriors and created the elite mercenary/bandit unit the Blades of Death. Perhaps because of the General's resentment, the unit does not take officers prisoner and often subjects all other prisoners to servitude, though warriors that surrender before battle are often let go without their ride or after a hefty ransom. Reinesblatt has turned his *Banshee* (formerly a -3S model) into a terrifying machine by replacing his PPCs with a large laser and LRM 10. For good measure, he completed his custom design by adding a massive axe.

Captain Greg Oliphant: Piloting a *Banshee* leaves many pilots sullen and resentful, but Oliphant is far from that. Inheriting his 'Mech, "*The Court Jester*," from his mother, he decorated it with a giant fool's cap with bells. As if violating one regulation wasn't enough, he has painted an elongated grin on its face. Despite his rebellious attitudes (or perhaps because of them), his company in the Seventy-first Regiment of Eridani Light Horse performs excellently in the field, and nothing can dampen his spirits.

El Guapo: Known only as "El Guapo," the commander of the Errai-based Old Crows Mercenary Company is notorious for his hard drinking and vicious fighting. El Guapo pilots a customized *Banshee*, constantly upgraded since its theft from the Nineteenth Galedon Regulars (an act that precipitated a feud between the mercs and the Regulars).

BNC-3E BANSHEE

Type: **Banshee**

Technology Base: Inner Sphere

Tonnage: 95

Battle Value: 1,422

Equipment

Internal Structure:

Engine: 380

Walking MP: 4

Running MP: 6

Jumping MP: 0

Heat Sinks: 16

Gyro: 4

Cockpit: 3

Armor Factor: 240

Mass

9.5

41

6

4

3

15

	Internal Structure	Armor Value
Head	3	9
Center Torso	30	40
Center Torso (rear)		17
R/L Torso	20	30
R/L Torso (rear)		10
R/L Arm	16	21
R/L Leg	20	26

Weapons

and Ammo

	Location	Critical	Tonnage
PPC	RT	3	7
AC/5	LT	4	8
Ammo (AC) 20	LT	1	1
Small Laser	H	1	.5

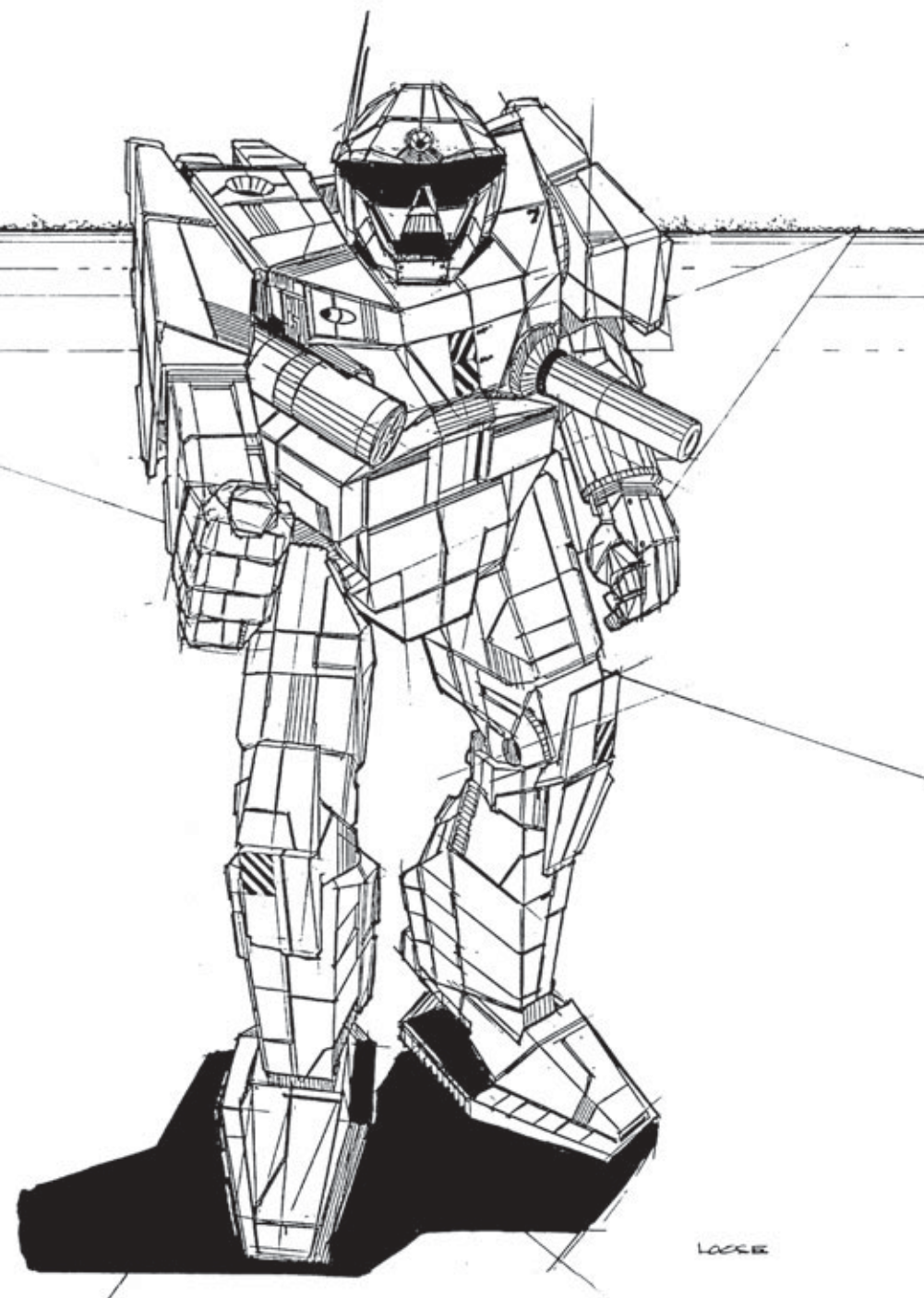

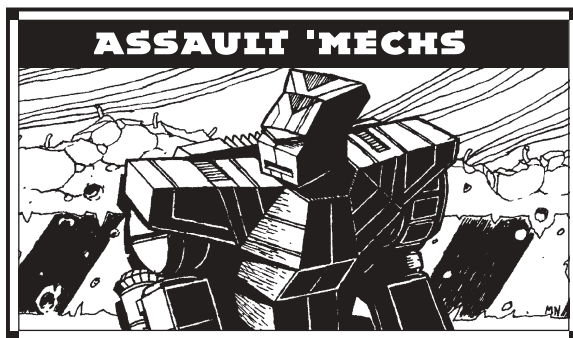

Mass: 100 tons

Chassis: Foundation Type 10X

Power Plant: Vlar 300

Cruising Speed: 32 kph

Maximum Speed: 54 kph

Jump Jets: None

Jump Capacity: None

Armor: Durallex Special Heavy

Armament:

- 1 Defiance 'Mech Hunter Autocannon
- 1 FarFire Maxi-Rack LRM 20
- 4 Defiance B3M Medium Lasers
- 1 TharHes Maxi SRM 6

Manufacturer: Defiance Industries, Yori MechWorks, Independence Weaponry

Primary Factory: Hesperus II (Defiance), Al Na'ir (Yori), Quentin (Independence)

Communications System: Angst Discom

Targeting and Tracking System: Angst Accuracy

Overview

When General Aleksandr Kerensky laid down the design specifications for the *Atlas*, he said it should be “a 'Mech as powerful as imaginable, as impenetrable as possible, and as foreboding as conceivable, so that fear itself will be our ally.” With the Regular army increasingly concerned with the growing strength of the House Lords’ personal armies, a new and powerful 'Mech was needed. Despite the coming war and the abandonment of the Inner Sphere by General Kerensky and most of the SLDF, the *Atlas* served its purpose.

Capabilities

The first impression any spectator gets of the *Atlas* is its ferocious appearance. The famous skull-head took designers a full year to perfect, and although there are taller 'Mechs on the field, none of them have the sheer presence of the *Atlas*.

As an assault 'Mech, the *Atlas* has few peers. The largest long-range missile launcher available sits in the left torso, giving the *Atlas* a powerful long-range punch. As the 'Mech closes it can bring a bevy of deadly weapons to bear, the most fearsome of which is the massive Defiance 'Mech Hunter Autocannon in the right torso with enough ammunition to decimate a company of 'Mechs. The cannon is backed by a six-tube short-range missile system and two pairs of medium lasers covering all sides of the 'Mech. Twenty heat sinks give the *Atlas* the freedom to use this firepower, and most MechWarriors are fearful of this 'Mech for very deserved reasons.

Very few if any BattleMechs carry more armor than the *Atlas*, and a complete set of actuators (including hands) give the 'Mech frightful physical combat capabilities. There are myths among MechWarriors of the *Atlas* actually picking up lighter 'Mechs and breaking them like toys.

If the *Atlas* has any weakness it would be its slow speed. Although other assault 'Mechs are as slow, the fact that an *Atlas* is easily escaped is the hope most MechWarriors have when they face such a machine.

Deployment

Although it was built for the Star League, almost all of the *Atlases* built during that era remained when General Kerensky vanished. Since then, production has continued to supply the Successor States with this 'Mech, and it has spread in limited numbers to every Successor State military. It is most often used as a command vehicle for senior commanders, although several common MechWarriors man them in assault lances as well.

Variants

Most militaries are loath to tamper with the *Atlas* for the simple reason that it seems nearly perfect in its role already. Attempted modifications generally fail since most engineers have to make too many concessions to keep the 'Mech functioning.

Notable MechWarriors

Prince Ian Davion: First Prince of the Federated Suns before Hanse Davion, Ian Davion fell in combat on Mallory's World in 3013 against House Kurita. While many scoff at a realm's sovereign entering battle, Ian Davion was a warrior first and a leader second, and his army loved him for it. During his final battle, Prince Davion held a vital pass against Yorinaga Kurita and his Second Sword of Light while his men made their escape. Although other units, including the Kell Hounds, were pushing forward to support him, he fell in battle before help could arrive.

General Aaron DeChavilier: Second-in-command of the SLDF under General Kerensky, General DeChavilier took part in the assault on Amaris' last stronghold. While history records Kerensky's *Orion* kicking in the gates, it was DeChavilier's *Atlas* destroying the outer wall that gave the Commanding General access to that famous gate. MechWarrior lore recounts how DeChavilier continually exposed his 'Mech to fire from the Usurper's defenses, trusting in his *Atlas*' heavy armor to protect him.

Hauptmann-General Kathleen Heany: A member of Field Marshal Nondi Steiner's staff and a former regimental commander in the Lyran Guard, Hauptmann-General Heany is a proponent of the “old school” of Lyran warfare. She routinely rejects the advice of the AFFS officers under her command and ignores any of the tactical innovations that the alliance with House Davion has brought to the LCAF. AFFS officers forced to serve under her apply for transfer as soon as possible, and those Davion units unlucky enough to be placed under her command chafe at the (to them) incompetent orders they are forced to follow.

AS7-D ATLAS

Type: **Atlas**

Technology Base: Inner Sphere

Tonnage: 100

Battle Value: 1,893

Equipment

		Mass
Internal Structure:		10
Engine:	300	19
Walking MP:	3	
Running MP:	5	
Jumping MP:	0	
Heat Sinks:	20	10
Gyro:		3
Cockpit:		3
Armor Factor:	304	19

	Internal Structure	Armor Value
Head	3	9
Center Torso	31	47
Center Torso (rear)		14
R/L Torso	21	32
R/L Torso (rear)		10
R/L Arm	17	34
R/L Leg	21	41

Weapons

and Ammo	Location	Critical	Tonnage
AC/20	RT	10	14
Ammo (AC) 10	RT	2	2
LRM 20	LT	5	10
Ammo (LRM) 12	LT	2	2
Medium Laser	RA	1	1
Medium Laser	LA	1	1
2 Medium Lasers	CT (R)	2	2
SRM 6	LT	2	3
Ammo (SRM) 15	LT	1	1

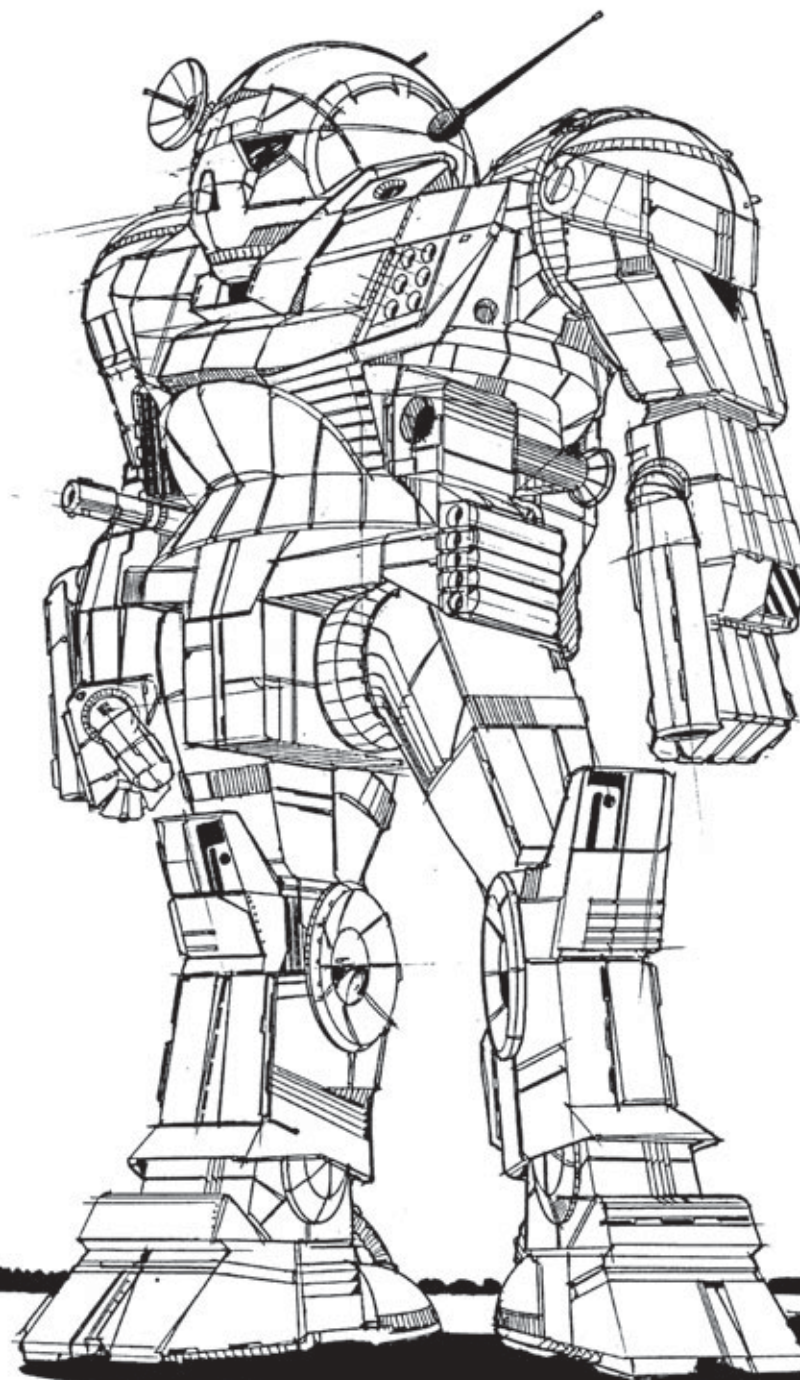

LOOSE



Though many consider these even more obsolete than conventional vehicles, conventional fighters have played an integral role in planetary defense, especially in star systems too poor or unimportant to have aerospace assets assigned to their defense. Often, a militia will procure three conventional fighters for the same cost of a single aerospace fighter of similar weight. The drawbacks of conventional fighters are, admittedly, numerous. They can only mount a limited amount of armor and weapons and can only operate on planets with breathable atmospheres. Despite this, conventional fighters remain in high demand, and every system has at least a squadron as token defense.

Conventional fighters are not, however, without advantages over their aerospace brethren. Their most distinct advantages are superior fuel (or reaction mass) economy, as conventional fighters can use air-breathing (or air-augmented) turbines unlike the rocket-powered aerospace fighters, and conventional fighters have distinctly superior atmospheric maneuverability because they need to make no compromises in aerodynamics for hypersonic and space operations. Conventional fighters are also often tasked with providing ground support because of their limited ability to force air superiority, which makes conventional fighters welcome sights for ground units that have seen their aerospace fighters repeatedly stripped away to fight an aerospace battle over a distant continent. It may not make an immediate difference on a battlefield, but conventional fighters also have an advantage in sustainability; they are much more easily supported (and built) by local industry than advanced vehicles like aerospace fighters.

Listed are the most commonly used military-grade designs and their variants. While other designs exist, many are only slight deviations of those listed here, and most of them are manufactured in such small numbers as to not make an impact to the sales of the designs listed here. In fact, a system with any sort of civilian-based manufacturing capability can (and often does) produce their own conventional fighters for the planetary defense and will forgo importing conventional fighters, instead using their locally produced brand (which are, again, only slightly different from the strike fighters listed here).

Previous Technical Readouts compiled conventional ground and wet-navy vehicles with their air-based brethren. However, many conventional fighters are almost always organized separately and in combat act similarly to aerospace fighters. Therefore it has been decided to move these designs to their own separate section.

[EDITOR'S NOTE: As with aerospace fighters (see that section beginning on p. 188), where appropriate, an "Upgrade" section has been included here.]

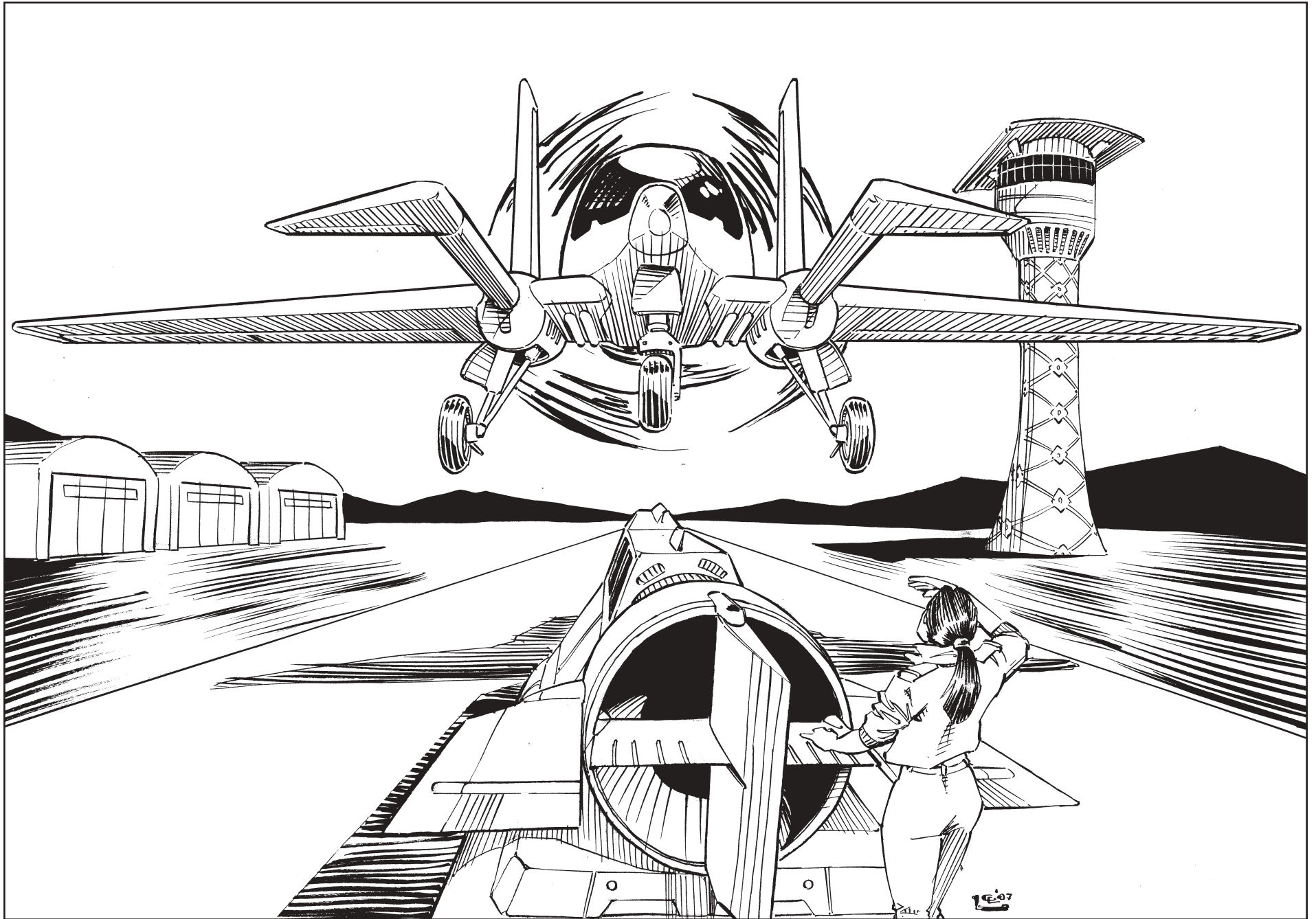



Mass: 5 tons

Power Plant: GM AeroProp Turbine

Armor: None

Armament:

None

Manufacturer: Cal-Boeing of Dorwinion

Primary Factory: Filtvelt

Communications System: Achernar Air Whistler

Targeting and Tracking System: None

Overview

Named for its V-shape, the Boomerang is representative of a typical spy plane used by the armed forces of the five Successor States. It acts as a mobile spotter for artillery units and as a forward observer for advancing 'Mechs.

Capabilities

The Boomerang is the Federated Suns' standard reconnaissance plane. Introduced in 2888, it was the first plane designed expressly for aerial recon in the Successor States era. Until then, civilian planes and their pilots were pressed into military service, with mixed results.

The Boomerang's most obvious feature is its long wingspan. The long, tapering wings make the plane fuel-efficient and also an excellent glide platform. The two forewings are perched on thin spars made of foamed aluminum, making them strong enough to support the winglets and their control cables. The forewings promote the craft's control and stability, making it almost impervious to stalls.

Two vertical stabilizers sit to either side of the pilot's cockpit. When in use, the entire stabilizer pivots, instead of just the trailing edge as on other airplanes. This, coupled with the stabilizer's placement in the swift airflow caused by the tapered slipstream, makes the Boomerang extremely maneuverable.

The engine, a standard electric turbofan design, is mounted just below the cockpit floor. It is highly efficient and quiet, using the 3,000-plus kilograms of fuel stored in the wings for a range of almost 5,000 kilometers—more, if the pilot chooses to glide for any length of time. The Boomerang's engine has an unusual heat-bleeding system that channels the heat waste through two slits on the upper edge of the wing between the two vertical stabilizers and the cockpit. The propeller then disperses the heat, making it difficult to trace the plane via infrared tracking devices. The large propeller is variable-pitched, reducing noise. The pitch also allows the pilot to feather the prop when putting it into glide mode; in this mode, the craft is virtually silent.

Such a large prop on an oddly proportioned plane posed some difficulties in designing suitable landing gear. The Boomerang's designers chose to stow the nose gear below the fuselage, and its long, thin landing wheels beneath the wings. Because of its large wingspan, the Boomerang requires only forty-four meters of landing space on a dry, level surface, and only seventy-five meters to take off.

The lightweight Boomerang does not have many of the computer-guided systems (which monitor the pilot's actions) common to larger aircraft. A Boomerang's pilot must therefore have a natural flair for flying. With its engine running, the big-winged Boomerang's maximum ceiling is almost 18,000 meters.

The Boomerang can carry over five hundred kilograms of reconnaissance gear, usually in the form of a pair of cameras with IR and low-light capabilities, enabling the Boomerang to function in all but the worst weather conditions. The two cameras can work independently, locking on two separate targets and relaying the information back to trailing Mosquito radar planes or even low-orbit DropShips.

The Boomerang's major weakness is its lack of arms and armor. To compensate for this vulnerability, the pilots usually fly at least three hundred meters off the ground, somewhat reducing the camera's abilities but keeping the pilot out of danger.

Deployment

The Boomerang has performed long and well in service to the Federated Suns. With lightweight, low-maintenance materials, the plane has an excellent repair history. Most active duty regiments and planetary militias have at least one Boomerang in operational condition. Heavy-action units such as the Davion Brigade of Guards typically have up to fifteen Boomerangs in the air during operational engagements.

The Boomerang—and most of its House counterparts—is easily disassembled quickly and stowed in the holds of even the smallest DropShip. The only complaint from most technicians is the delicacy of the camera sensors; heavily ionized or irradiated atmospheres tend to corrode the sensors faster, degrading the cameras' performance.

Variants

As many variants exist as House militaries; the key differences between them mainly lie in silhouette and optics quality. The Capellan Dragonfly has a knockoff Eo electric engine that tends to short out after a few seconds of sustained G-force application. The Kuritan Shuriken has a smaller wingspan, necessitating longer runways. The Lyran Warbler mounts radio interception gear in place of one camera system—though if not counterbalanced in the nose, it tends to stall more easily. The Marik Hyperion's cockpit forces the pilot to lie horizontally inside the wing-like fuselage, allowing the pilot to rest during extremely long sorties but mandating a complete reliance on instruments and sensors to fly the craft.

BOOMERANG SPOTTER PLANE

Type: **Boomerang Spotter Plane**
 Chassis Type: Fixed Wing (Small)
 Mass: 4,999 kg
 Technology Base: Inner Sphere (D/X-E-E/C)
 Battle Value: 8

Weapons and Ammo	Location	Mass
Recon Camera	Nose	500 kg

Crew: 1
Cargo:
 13 kg standard 1 Door (Front)

Equipment		Mass
Chassis/Controls:		360 kg
Engine/Trans:	ICE	750 kg
Safe Thrust:	4	
Max Thrust:	6	
Structural Integrity:	4	
Heat Sinks:	0	0 kg
Fuel:273 (Petrochemical)		3,276 kg
Armor Factor (BAR 2):	0	0 kg
	<i>Armor Value</i>	
Front	0	
R/L Side	0/0	
Rear	0	

Note: Features Ultra-Light, STOL, and Prop Chassis and Control Modifications, and 1 Ejection Seat (100 kg)

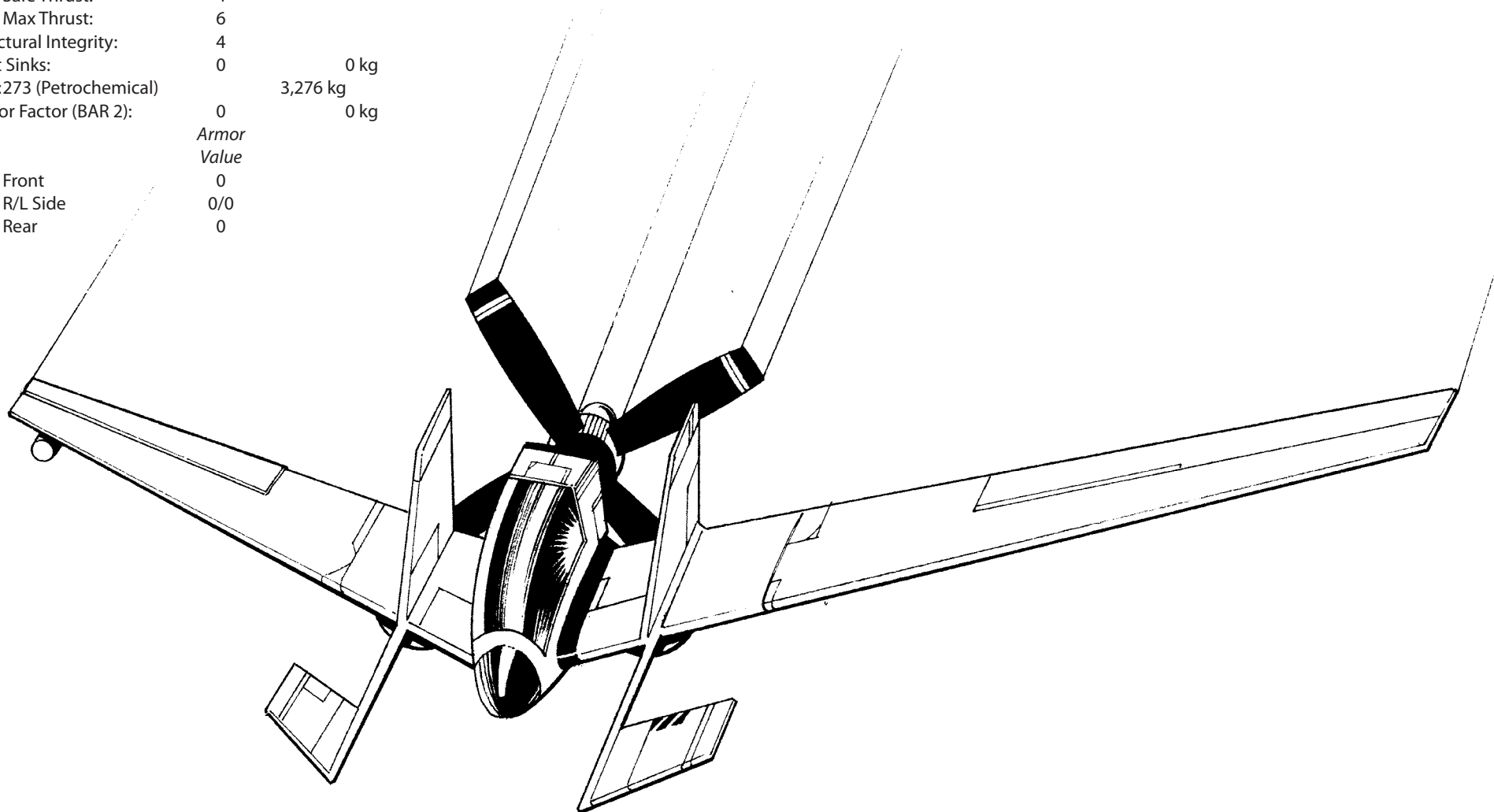



Mass: 10 tons

Chassis: Andurien NGL

Power Plant: Hermes 100 AeroFusion

Armor: Durallex Light

Armament:

1 Irian Weapons Works Class 4 SRM Pack

Manufacturer: Andurien AeroTech

Primary Factory: Lopez

Communications System: Lassitor 2MA

Targeting and Tracking System: IMB Hawkeye 30

Overview

Although BattleMechs and aerospace fighters tend to dominate the battlefields of land, air, and space, conventional fighters have formed the backbone of air defense for far more worlds in the Inner Sphere than most armchair generals tend to credit. With so many worlds possessing the industrial capacity to produce their own conventional fighters, the variety of these craft is quite impressive, with a few universal standards set by the likes of the Guardian, the 'Mechbuster, and the Boeing Jump Bomber. The Angel Strike Fighter, a Star League-era introduction from the Free Worlds League, is another example of a conventional fighter that has become a household name across the Inner Sphere.

Capabilities

Initially produced during the heyday of the Star League, the Angel is a somewhat rare breed in conventional fighter designs. Weighing in at only 10 tons, it is powered by a fusion-heated turbine rather than the normal combustion turbines generally favored by conventional fighter manufacturers. Though seen by many planetary garrisons as an expensive extravagance, the Hermes 100 AeroFusion plant provides incredible thrust, making the Angel one of the fastest and most maneuverable fighters in its atmospheric element, an excellent feature in a craft intended for both fast strikes and reconnaissance work. Unfortunately, the lightweight nature of the Angel eschews heavy armor, making the fighter impractical as a dogfighter, though its nose-mounted SRM 4 pack offers a potent sting against other light fighters and ground vehicles.

Deployment

During the Golden Age of the Star League when the Angel was first produced, Andurien AeroTech managed to secure purchase orders from across the Inner Sphere and Periphery, spreading the design across known space. Because of this, when Capellan forces destroyed the Lopez complex in the early Succession Wars, the Angel survived in the form of numerous copycat models, such as the Federated Suns' Comet (produced today by Lycomb-Davion IntroTech) and the Lyran-made Owl (produced by Shipil of Skye). By the time the Lopez facilities got rebuilt, manufacturers in all five Great Houses had begun their own production lines for this fighter.

Of course, the Hermes 100 AeroFusion engine (and foreign equivalents) has prevented light strike fighters stamped from the Angel's mold from maintaining the popularity of combustion-powered conventional fighters during the Succession Wars.

Variants

Over the centuries, there have been many minor variations on the Angel's basic design, most altering the craft's weapons load or experimenting with less-expensive turbine engines. Among the most successful are the slower-moving Kurita-made Suzume ("Sparrow"), which trades the SRM for a LongFire V LRM 5, and adds fifty percent more armor to the fighter's wings. The Lyran-made Angel variant, dubbed the Owl II, retains the fusion engine but exchanges the SRM for a nose-mounted medium laser, two wing-mounted small lasers, and an extra ton of fuel for greater operating range.

Upgrades

During the FedCom Civil War, the Shipil Company on Skye unveiled an improved Owl II (the Owl III), which replaces the Owl II's lasers with two extended-range medium lasers on the nose. Meanwhile, Andurien Aerotech has unveiled its own take on the Owl's laser configuration, but the company took the more radical approach of downgrading the fusion engine to an AeroOmni 70, adding a ton of additional fuel, and trading the SRM for nose-mounted medium and small pulse lasers, with an extra extended-range small laser mounted on the tail to deter pursuers.

Notable Pilots

Remi Lanakir: Once an ace in the FWLM, Force Commander Lanakir semi-retired after the Fourth Succession War to reserve status with the planetary air guard on New Olympia, where he also came to serve as a guest instructor for the Lloyd Marik-Stanley Aerospace School. An expert at the controls of his Angel Light Strike Fighter, Lanakir particularly revels in demonstrating the flexibility of conventional fighters over their aerospace equivalents during atmospheric engagements. According to some reports, his simulated kill credits as an instructor at LMS have made him a double-ace and include at least one 'Mech—a *Hermes II* from the nearby Allison MechWarrior Institute.

ANGEL LIGHT STRIKE FIGHTER

Type: **Light Strike Fighter ("Angel" Variant)**
 Technology Base: Inner Sphere
 Tonnage: 10
 Battle Value: 145

Weapons and Ammo
 SRM 4
 Ammo (SRM) 25

Location	Tonnage	Heat	SRV	MRV	LRV	ERV
Nose	2	0	6	—	—	—
—	1	—	—	—	—	—

Equipment		Mass
Engine:	100	4.5
Type:	Fusion	
Safe Thrust:	10	
Maximum Thrust:	15	
Structural Integrity:	10	
VSTOL Equipment:		0
Heat Sinks:	10	0
Fuel:	160	1
Cockpit:		1
Armor Factor:	8	.5
	<i>Armor Value</i>	
Nose	2	
Wings	2/2	
Aft	2	

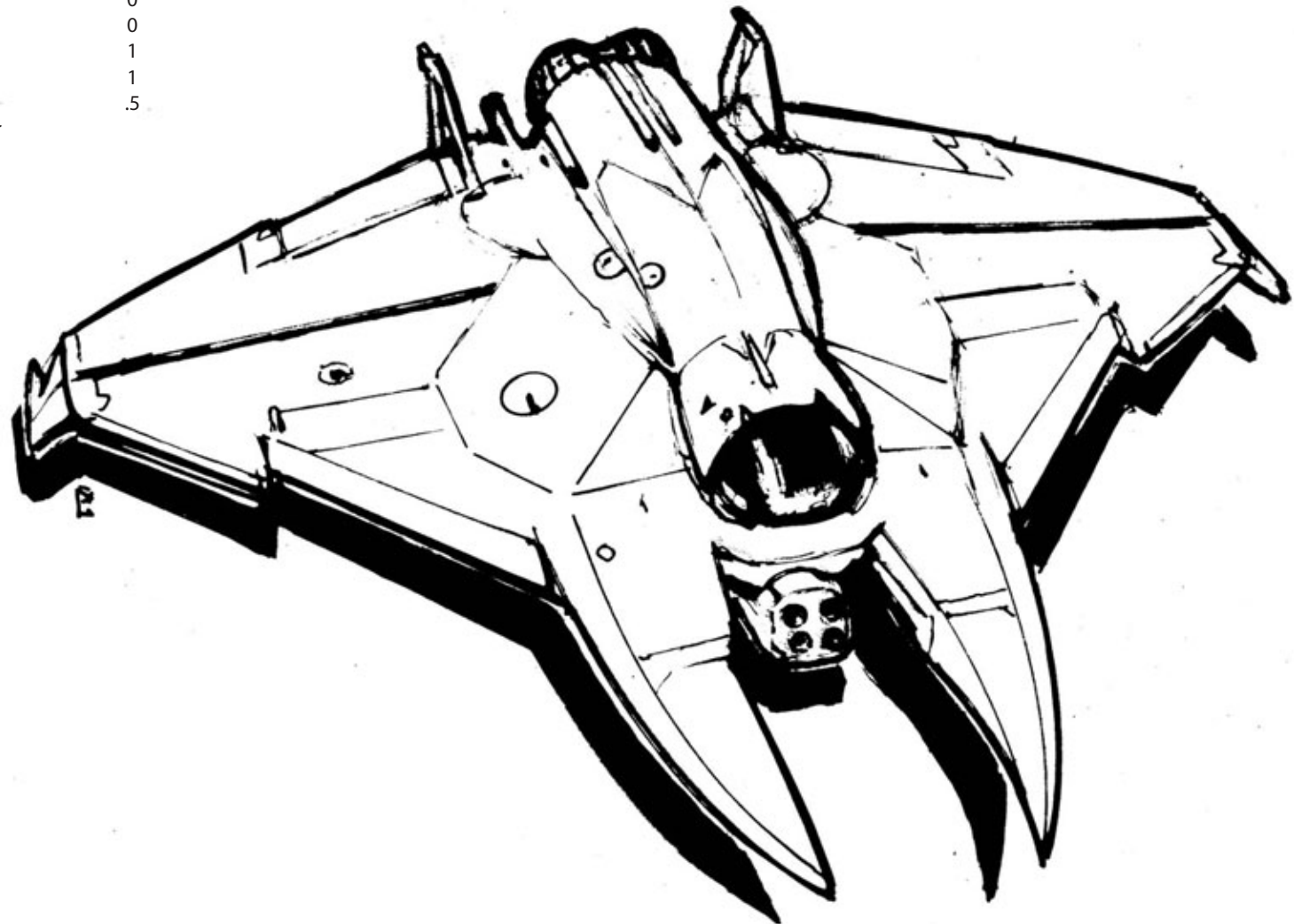



Mass: 20 tons

Chassis: Boeing X550

Power Plant: GM 180 Turbine

Armor: Boeing Standard Plating

Armament:

None

Manufacturer: Federated Boeing

Primary Factory: Galax

Communications System: Boeing A30

Targeting and Tracking System: Boeing 200

Overview

Military planners inside Federated Suns space anticipated Capellan attempts to exploit upcoming Federated Commonwealth actions against House Kurita. To address this possibility, the AFFS began to heavily fortify key systems along the Capellan border. The planners repeatedly requested additional aerospace fighters be permanently stationed on those worlds to provide air support for the ground defense forces. Even the alliance with the Lyrans and the technological recovery coming from the Helm Memory Core was insufficient to produce adequate quantities of vehicles as advanced as aerospace fighters. Since there were not enough fighters to leave idle on non-capital planets, the planners' requests were refused. The AFFS decided to resort to swarms of much less expensive conventional fighters to fill the ground support role. Federated Boeing was the only company to approach the bid with a working prototype, and so they easily secured the contract.

Capabilities

The two main features of the Jump Bomber are its low cost and high speed. Costing just under 160,000 C-bills each, the Boeing Jump Bomber is one-sixth as expensive as the cheapest aerospace fighter. Boeing shamelessly based the Jump Bomber on the successful Capellan Guardian fighter. Federated Boeing started with the Guardian chassis, modified it for the more advanced manufacturing facilities Boeing had available, and kept the popular integral diagnostic system while removing most of the armor and weapons to install a larger engine. The high thrust allows the fighter to swiftly carry a full external payload across the battlefield.

However, paper-thin armor guarantees that most Jump Bombers encountering hostile fire will not come back. Since most conventional fighters cannot survive return fire anyway, Federated Boeing mounted only a single ton to shield the internals from weather and small arms fire. This was deemed adequate, since Boeing planned to borrow something else from House Liao's Guardian—several remote bomb release tactics. Capellan pilots had developed alternatives to suicidal dive-bombing runs such as "toss bombing," where the aircraft would release bombs in upward arcs and turn away before reaching the target zone. The high speeds and angle of attack would carry the ordnance to the target area.

Another feature the Boeing Jump Bomber kept from the original Guardian design is its VSTOL capability. This has allowed many commanders the options of bringing in Jump Bombers on offensive missions. Even if airstrips are not taken in the initial landings, the Jump Bomber can follow the main force just about anywhere on the planetary surface as long as fuel and bombs are supplied.

Deployment

The first run of twenty-five Jump Bombers went straight to Marlette in the late 3030s. No other customers, militia or mercenary, approached Federated Boeing to purchase additional Jump Bombers, preferring to see how well they fair in combat first. Being a recent design relative

to the scope of this technical readout, no combat history would be recorded until 3044, when the mercenary unit McCarron's Armored Cavalry attacked the system, where the Jump Bomber functioned properly but failed to turn the tide of the campaign—or to make any significant impact at all.

Variants

These are more theoretical than fact. Commanders interested in the design have been attempting to mount external one-shot short-range missile packs to the wings in place of bombs to provide air cover for other Jump Bombers in case hostile aircraft are in the area. Others have asked Federated Boeing to increase the Jump Bomber's weight slightly to allow more ordnance to be carried. However, maintaining the same airspeed on an enlarged airframe would require a fusion engine, more than tripling the cost of the fighter and defeating a key selling point of such a niche design.

Upgrades

No upgraded variants of the Boeing are known to exist, though most now take advantage of the greatly increased range of external stores.

Notable Pilots

Captain Jarred Bensen: Pilot Bensen barely graduated flight school, leaving as one of the lowest in his class when he was approached by Federated Boeing to test out the new Jump Bomber. Boeing believed that inexperienced pilots were the key to making their sales strategy for the Jump Bomber work, as Bensen would be representative of the grade of pilots found in planetary militias. Known for having poor aim during flight training, Bensen was ideal for the Boeing program. The relatively simple, pilot-friendly craft accommodated Bensen's level of skill well, and he was able to hone his skills and train other newly recruited pilots on the effective use of the Jump Bomber.

BOEING JUMP BOMBER

Type: **Boeing Jump Bomber**
Technology Base: Inner Sphere
Tonnage: 20
Battle Value: 64

Weapons and Ammo
None

Location
—

Tonnage
—

Heat
—

SRV
—

MRV
—

LRV
—

ERV
—

Equipment		Mass
Engine:	180	14
Type:	Turbine	
Safe Thrust:	9	
Maximum Thrust:	14	
Internal Structure:	9	
VSTOL Equipment:		1
Heat Sinks:		0
Fuel:	320	2
Cockpit:		2
Armor Factor:	16	1
	<i>Armor Value</i>	
Nose	7	
Wings	3/3	
Aft	3	

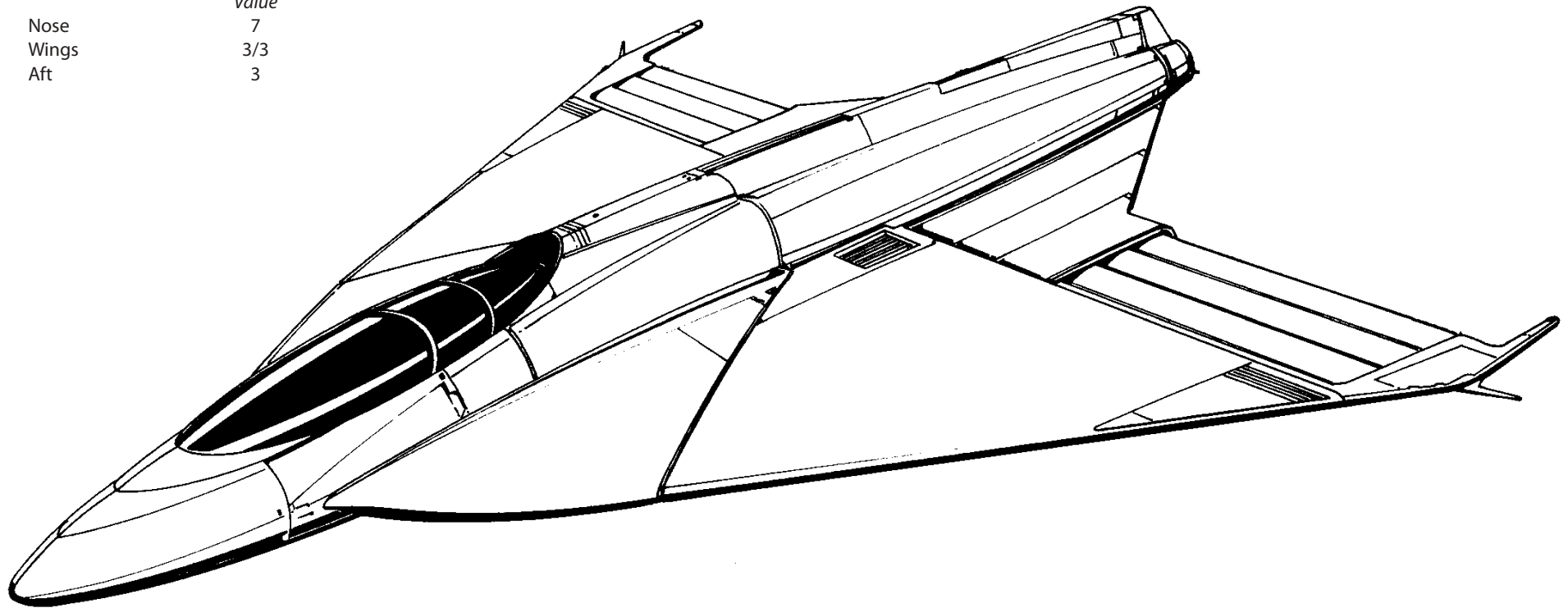



Mass: 20 tons

Chassis: Mujika Aerospace Type 4

Power Plant: Rawlings 140 Air Turbine

Armor: Mujika AeroShell Light

Armament:

1 Sian/Ceres Cougar SRM 6

Manufacturer: Mujika Aerospace Technologies

Primary Factory: St. Ives

Communications System: XDuteck 20

Targeting and Tracking System: Radcom T5

Overview

In modern warfare the BattleMech is the most visible component of the cutting edge of military science. The aerospace fighter, while older in design, has fallen behind these metal behemoths if only because of their relative scarcity. A space superiority fighter is more difficult to salvage than a 'Mech. If a 'Mech's movement system is disabled, it falls over, ready to be salvaged and made new. If an aerospace fighter's drive system is disabled, it disappears into the vastness of space or spreads itself across a few kilometers of debris. It is only the amazing value of air support for ground operations that keeps these vessels in the atmosphere at all. Any state that can support the scarce aerospace industrial facilities turns to fusion-powered aerospace fighters to keep the skies under their control.

States that cannot support them turn to conventional fighters like the Guardian.

First issued in 2831, the Guardian-class atmospheric fighter is designed for ground support exclusively. Although its speed is spectacular when compared to ground assets, against fusion-powered craft it is all but helpless. The true advantage of this craft over standard aerospace fighters is its simplicity; man has been flying with jet turbines longer than he has been flying with fusion torches, and the technology to maintain these craft is very basic. Few worlds can't maintain at least a token force of atmospheric fighters, and the Guardian is more simple than most. A world that cannot support a single light aerospace fighter can maintain a regiment of atmospheric fighters.

Capabilities

The Guardian's airframe is wrapped around a powerful Rawlings 140 Air Turbine engine, which is equipped with four vectored-thrust nozzles to give it adequate very-short-take-off-and-landing (VSTOL) capabilities. When carrying only its own integral weapons load, the Guardian can lift straight up, but even with a maximum bomb load the fighter only requires fifty meters of runway.

Logistically the Guardian is a dream. Designed on the edge of obsolescence from the start, the Guardian is easily maintained from local equipment stocks. The electronics, avionics, and engine fittings are of semi-modular design, allowing for easy adoption of local replacement parts. Every Guardian comes equipped with a computer fault self-tester, capable of diagnosing the fighter's flaws and suggesting replacements from pre-selected stores lists. When combined with the simplicity of design, the maintenance workload on this fighter is far lower than almost any other vehicle in modern use.

The only downside is the Guardian's lack of protection. Although its speed grants it a certain amount of safety, the airframe is not strong enough to carry any reasonable amount of armor protection. For this reason alone it is very rare to see pilots rated in fusion-powered aerospace craft switch to atmospheric fighters; even the lightest aerospace fighter can carry far more armor protection, leading to bad piloting habits amongst aeriojocks that can be hard to break.

Aside from its bomb capacity, the Guardian also carries a standard Sian/Ceres Cougar SRM 6 in the nose as a strike weapon. Although detractors are hasty to point out how much more valuable one or two lasers would have been for strafing attacks, the role of the Guardian is more suited to the one-time burst of damage that a well-timed barrage of missiles can do. Pilots who would repeatedly expose their craft to damage—as a series of strafing attacks would encourage—do not last long in these thin-skinned craft.

Deployment

The Guardian is most often found in Liao garrisons across the Confederation. During the Fourth Succession War, Davion MechWarriors learned to fear packs of Guardians appearing out of nowhere to bomb unsuspecting 'Mech formations. Unfortunately for the Guardians, the makeup of the standard AFFS regimental combat team provided adequate aerospace fighter support. The fusion-powered *Corsairs* and *Stukas* made short work of the Guardians once they were located.

Variants

Popular demands forced a small production run of the Guardian B, which reduces the fighter's speed to replace the short-range missiles with a medium laser and its ancillary equipment. Most of these craft were destroyed during the Fourth Succession War, crippled by weak armor and low speeds.

Upgrades

Recent technological advances have produced two new Guardian variants; the C mounts an ammunition-efficient Streak SRM 4 pack in place of the old SRM 6. The D variant replaces the SRM with an MRM 10 launcher.

Notable Pilots

Sergeant Emma Guth: Sergeant Guth pilots a Guardian with Galaport Security Services. With the sheer size of Galaport, Guth's Guardian B is often assigned to find missing ground tugs or stolen baggage trains.

GUARDIAN FIGHTER

Weapons and Ammo	Location	Tonnage	Heat	SRV	MRV	LRV	ERV
SRM 6	Nose	3	4	8	—	—	—
Ammo (SRM) 15	—	1					

Type: **Guardian Fighter**
 Technology Base: Inner Sphere
 Tonnage: 20
 Battle Value: 176

Equipment

Engine:	140	Mass	10
Type:	Turbine		
Safe Thrust:	7		
Maximum Thrust:	11		
Structural Integrity:	7		
VSTOL Equipment:		1	
Heat Sinks:	0	0	
Fuel:	320	2	
Cockpit:		2	
Armor Factor:	16	1	
	<i>Armor Value</i>		
Nose	6		
Wings	3/3		
Aft	4		

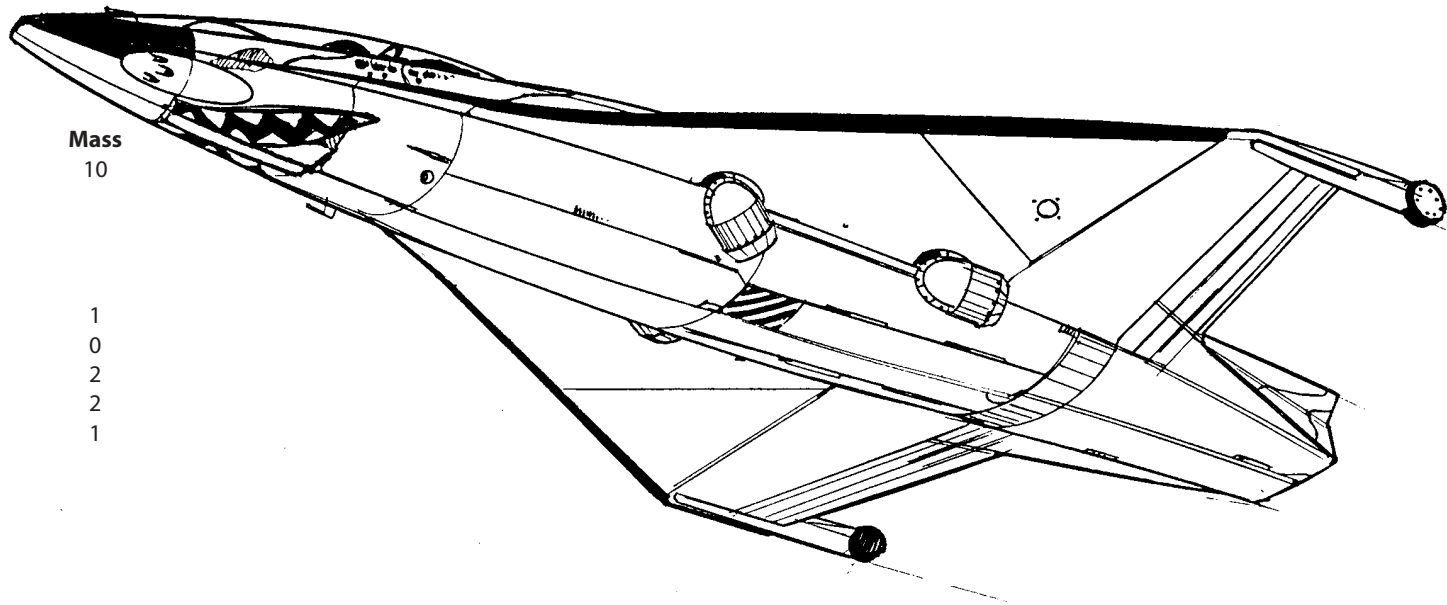



Mass: 25 tons

Chassis: Imstar DF/25

Power Plant: Imstar-C 150 Turbine

Armor: Riese Heavy

Armament:

1 Irian Weapon Works Class 2 SRM

2 LongFire LRM 5 Launchers

Manufacturer: Imstar Aerospace

Primary Factory: Amity

Communications System: Lassitor 2JA

Targeting and Tracking System: IMB SYS 3000

Overview

As with the Angel Light Strike Fighter, the Defender Medium Strike Fighter has become a universal standard in middleweight conventional fighters since its debut in the days of the Star League. The Defender was first introduced by Imstar Aerospace of Amity for planetary air garrisons across the Free Worlds League, particularly those with less funding. An aggressive interstellar sale program and the openness of the Star League gave Imstar room to sell these “poor man’s defense” assets across the Inner Sphere, whether it was in the form of actual constructed airframes or specs and licenses to duplicate them.

Capabilities

Powered by reliable Imstar-C air-breathing turbines, the Defender is an inexpensive fighter that achieves excellent airspeed for a conventional craft—enough to overtake (or, if needed, outrun) a Planetlifter or ‘Mechbuster. As an atmospheric fighter, it is also far more adept at in-atmosphere dogfighting than aerospace fighters with the same thrust capabilities, though it remains quite fragile compared to such fighters. This combination of speed and maneuverability with an arsenal of short- and long-ranged missiles makes the Defender an ideal choice for engaging other conventional fighters, VTOLs, or ground targets, while also providing a relatively inexpensive support craft for engaging low-flying aerospace units.

Deployment

Once more owing to a production boom in the Star League era and the subsequent Succession Wars, the Defender became a widespread design. This fighter was produced across the Inner Sphere under a variety of names (but almost always the same performance profile and general configuration) and overtook competitors, even aerospace fighters, simply because it was easy to build with the technology found on the average planet rather than some super-advanced subcontracting factory now blown up or isolated by shortages of JumpShips. House Steiner became one of the biggest users during the later Succession Wars, however, as they deployed both standard and variant models of these strike fighters to many border worlds as part of a token effort to strengthen previously low-priority garrisons.

Variants

During the Second Succession War, Lockheed/CBM of Gibbs introduced a carrier-launched version of the Defender—locally dubbed the Kaiseradler (roughly “Imperial Eagle”)—for use by Lyran air defense forces. This variant reduced its fuel capacity by one ton but added VSTOL capabilities ideal for short runways and carrier landings, and traded its armament for two wing-mounted TharHes Blue SRM 4 racks and a pair of Kicker machine guns. To offset its range disadvantages, this variant was often paired with unmodified Defenders (locally produced as the Steinadler, or “Golden Eagle”).

The Capellan Confederation, meanwhile, came to produce its own Defender variant (the Crane) at Mujika Aerospace Technologies on St. Ives (alongside the venerable Guardian). This model carries a third five-tube LRM launcher in place of the nose-mounted SRM and links all three launchers into a single ammunition bin. The resulting fighter has improved hitting power at long range—enough to endanger most other conventional fighters with even a single volley.

Upgrades

After rediscovering Artemis IV fire-control technology in 3035, engineers in the Free Worlds League developed one of the first lostech upgrades for a conventional fighter by installing the system on their Defenders in 3038, producing the Defender II. This Artemis variant—which would again become a Sphere-wide standard, supplanting the original Defender—drops the nose-mounted SRM in favor of Artemis fire control upgrades for the wing-mounted LRMs. While this slightly reduces its short-range potential, the fighter enhances its effectiveness against more distant targets.

Notable Pilots

Miguel Tiborovich: As a subcommander in the Second St. Ives Lancers, Tiborovich was a brash and arrogant pilot of a *Trangressor* heavy fighter whose kill record never quite offset his proclivity for back-talking his superiors and challenging his fellow warriors to mock air duels. Rather than cashier him outright, however, Tiborovich’s superiors instead transferred him to a local militia command on Warlock and “promoted” him to a conventional carrier flight command aboard an aging *Lucius Zhao*-class escort carrier, the WCN *Tarnished Blade*. His ego badly bruised, Tiborovich nevertheless developed an affinity for his Crane-variant Defender and even received credit for the assisted kill of two Capellan-backed mercenary fighters who struck at Warlock during a minor raid in 3032.

DEFENDER MEDIUM STRIKE FIGHTER

Type: **Medium Strike Fighter ("Defender" Variant)**

Technology Base: Inner Sphere

Tonnage: 25

Battle Value: 259

Equipment

		Mass
Engine:	150	11
Type:	Turbine	
Safe Thrust:	6	
Maximum Thrust:	9	
Structural Integrity:	6	
VSTOL Equipment:		0
Heat Sinks:	0	0
Fuel:	480	3
Cockpit:		2.5
Armor Factor:	24	1.5
	<i>Armor Value</i>	
Nose:	7	
Wings:	6/6	
Aft:	5	

Weapons and Ammo

	Location	Tonnage	Heat	SRV	MRV	LRV	ERV
SRM 2	Nose	1	0	3	—	—	—
Ammo (SRM) 50	—	1					
LRM 5	RW	2	0	3	3	3	—
LRM 5	LW	2	0	3	3	3	—
Ammo (LRM) 24	—	1					

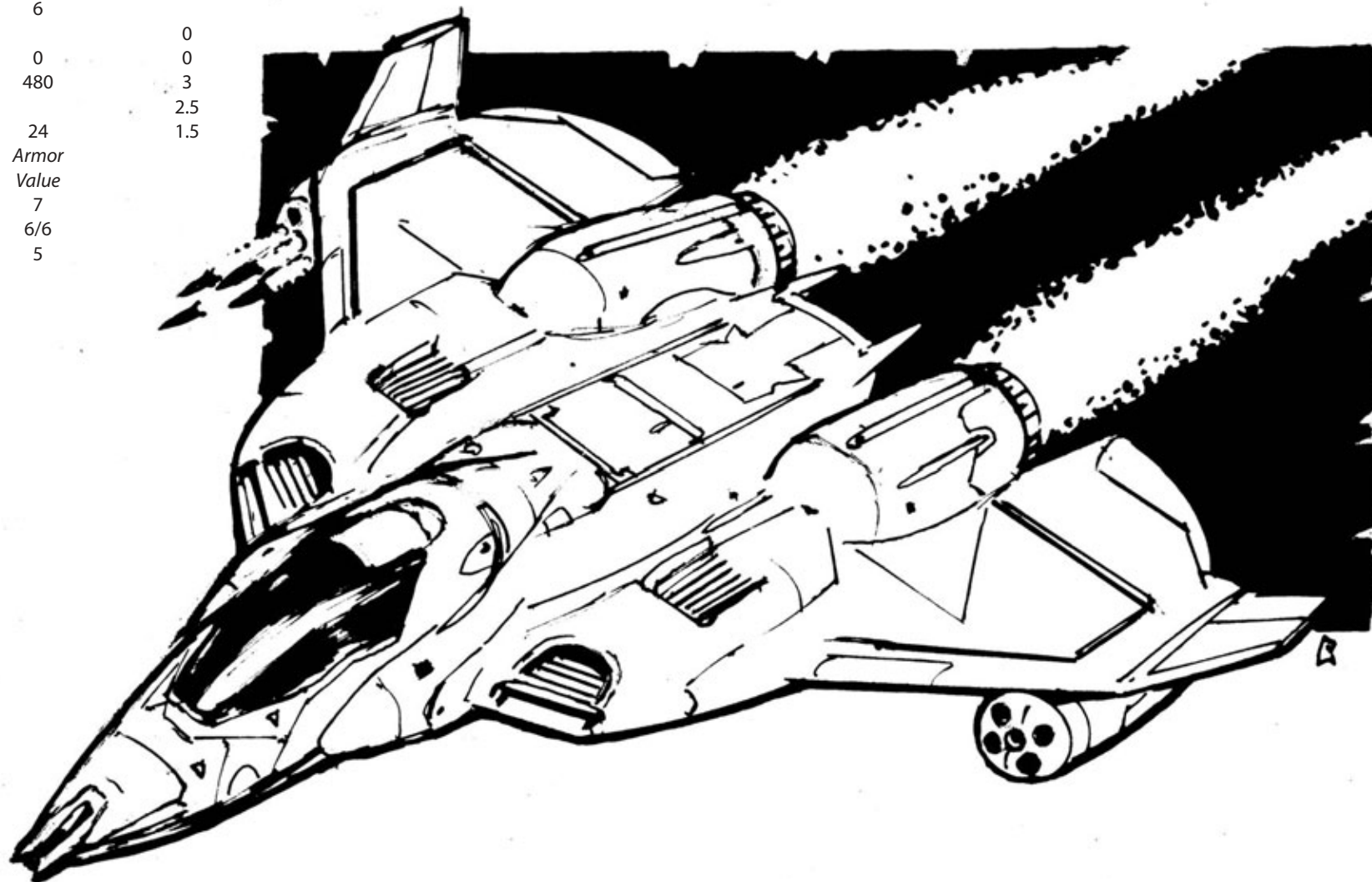



Mass: 45 tons

Chassis: JA-MTR-Airframe

Power Plant: GM 225 Atmo-Fusion

Armor: StarGuard II

Armament:

1 Mydron Model B Autocannon/10

2 Holly SRM 4 Launchers

Manufacturer: Jalastar Aerospace

Primary Factory: Panpour

Communications System: O/PR Janxiir

Targeting and Tracking System: TargiTrak 700

Overview

During the heyday of the Star League, Andurien Aerotech and Imstar Aerospace—both notable Free Worlds-based aerospace companies—debuted and produced conventional fighters that have become standards known far and wide across human-occupied space. Not to be outdone, the Federated Suns also managed to claim a piece of that same military niche when Jalastar Aerospace introduced its for-export conventional fighter concept, the Meteor Heavy Strike Fighter. Rather than mimicking the aggressive international sales approach used by its Free Worlds competitors, however, Jalastar took a more direct marketing strategy and aimed their strike fighter at customers in the Terran Hegemony.

Capabilities

Though it has become the standard by which heavy strike fighters are defined, the Meteor—like Andurien Aerotech's Angel—is unusual today for its fusion-based design, which saved tonnage but produced a higher

initial price tag. However, price was only a minor concern to the Hegemony buyers when the Meteor debuted, and the asking price allowed Jalastar to provide a fighter with respectable airspeed and maneuverability while leaving room for heavy weapons and respectable armor (for a conventional fighter).

The centerpiece of the Meteor's arsenal was its nose-mounted Mydron B heavy autocannon, which boasted two tons of munitions for sustained medium-range firepower. A single hit from the weapon could down most conventional fighters and even cripple lighter aerospace fighters foolish enough to tempt their fate against it. Backing this weapon was a pair of wing-mounted Holly SRM 4 packs, which are particularly ideal in anti-ground attack runs against vehicles or when targeting low-flying VTOLs. Even with this formidable array, however, most Meteors were often billed as bomber-fighters and often flew into battle laden with enough external ordnance to threaten small concentrations of ground forces, including BattleMech and armor companies.

Deployment

Jalastar's Terran-directed marketing campaign ended up having the same effect on Meteor sales as Andurien Aerotech's and Imstar Aerospace's Sphere-wide approach did with the Angel and the Defender strike fighters. Third-party sales prior to the fall of the Star League saw the Meteor exported to planetary garrisons across human-occupied space. When the Star League fell, the Great Houses claimed scores of these fighters as each one seized its respective slice of Hegemony territory. The widely available specs allowed for a boom in homegrown production, making the Meteor the template by which all heavy strike fighters would be known.

Variants

House Kurita produced both a carbon copy Meteor (which they dubbed the Inseki, or "Meteorite") and an after-market upgrade variant—the Inseki II—that took full advantage of the fusion plant by trading the fighter's weapons for a nose-mounted Hellstar PPC, a pair of wing-mounted Telos DecaCluster LRM 10 racks, and a tail-mounted machine gun to deter close pursuit.

A Taurian-made variant known as the Bat Hawk uses a locally produced 225-rated turbine engine in place of the more expensive fusion plant and retains the nose-mounted heavy autocannon. The wing-mounted SRMs were deleted in favor of the heavier engine and replaced by a single, nose-mounted Harvester SRM twin-pack.

Upgrades

A recent Free Worlds-made upgrade of the Meteor was introduced in 3060 by Gutierrez Aerospace on Trellisane and was made available for export sale despite misgivings among the Free Worlds League's LCCC. This variant, based on the League-model Meteors and dubbed the Meteor-G, trades in the older Mydron Model B for a Corean Light Gauss Rifle and replaces the old Holly 4 packs with more efficient Guided Technologies 2nd Gen Streak SRM 4. These changes, however, forced the designers to reduce the Meteor-G's range by one third.

An upgraded FedSuns variant known as the Meteor-U upgrades the Mydron B to an Ultra series and replaces each wing-mounted SRM launcher with a pair of Intek medium lasers, adding two heat sinks to handle the load. Like the Meteor-G, this variant sacrifices endurance but nearly doubles its offensive punch in combat.

Notable Pilots

Valerie "Valkyrie" Sunrider: A lieutenant in the planetary air guard on Baxter, "Valkyrie" Sunrider flew an unmodified Lyran-made Meteor into battle against Kurita raiders in 3034. Lacking suitable air cover—and underestimating the capabilities of Baxter's conventional air guard—the DCMS units became easy prey for Sunrider's squadron. Though her dove-white and Steiner-blue fighter was shot down by an enemy *Panther*, Sunrider's air-to-ground strikes and bombing runs had crippled two Combine BattleMechs and destroyed two vehicles. Sunrider safely ejected and received a commendation from the LCAF before returning to active duty with a replacement Meteor.

METEOR HEAVY STRIKE FIGHTER

Type: **Heavy Strike Fighter ("Meteor" Variant)**

Technology Base: Inner Sphere

Tonnage: 45

Battle Value: 451

Equipment

		Mass
Engine:	225	15
Type:	Fusion	
Safe Thrust:	5	
Maximum Thrust:	8	
Structural Integrity:	5	
VSTOL Equipment:		0
Heat Sinks:	10	0
Fuel:	480	3
Cockpit:		4.5
Armor Factor:	40	2.5
	<i>Armor Value</i>	
Nose	12	
Wings	10/10	
Aft	8	

Weapons and Ammo

AC/10	
Ammo (AC) 20	
SRM 4	
SRM 4	
Ammo (SRM) 50	

Location	Tonnage	Heat	SRV	MRV	LRV	ERV
Nose	12	0	10	10	—	—
—	2	—	—	—	—	—
RW	2	0	6	—	—	—
LW	2	0	6	—	—	—
—	2	—	—	—	—	—

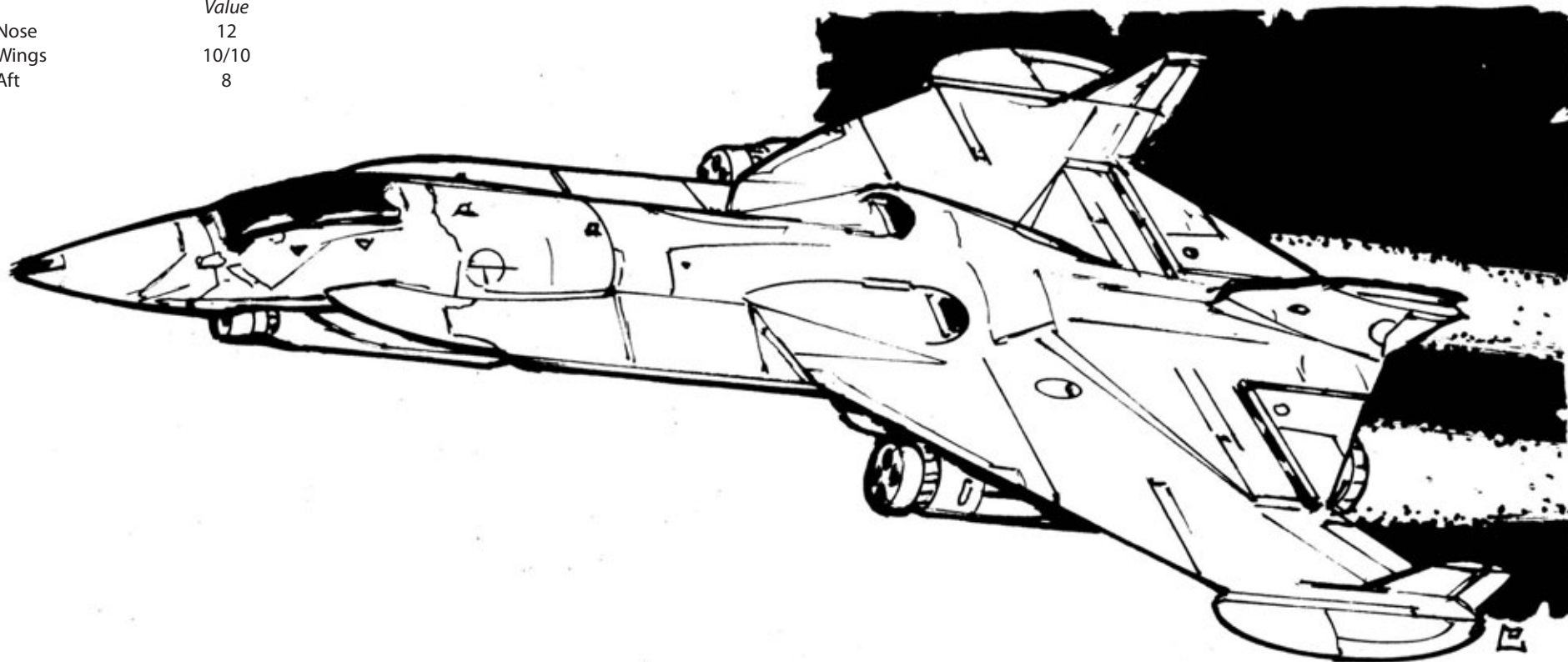



Mass: 50 tons

Chassis: Shinobi III Standard

Power Plant: Shinobi 250 Turbine

Armor: Buster Standard

Armament:

1 Zeus-75 Mark IX Autocannon/20

Manufacturer: Gorton, Kingsley & Thorpe Enterprises

Primary Factory: Rasalhague

Communications System: Duoteck 5

Targeting and Tracking System: RCA Instatrac MK II

Overview

A hastily designed conventional fighter produced as a stopgap for dwindling aerospace fighters, the 'MechBuster nonetheless performed admirably for its short production run. Thousands were churned out until Wakazashi was able to re-tool their lines for more effective aerospace designs right before the outbreak of the Fourth Succession War.

With the formation of the Free Rasalhague Republic and the destruction inflicted during the *Ronin Wars*, the Draconis Combine "gifted" the design and all rights to the fledgling state, allowing it to produce a cheap and effective fighter to defend its systems from any possible Lyran aggression, and production re-started.

Capabilities

What led to the end of the production run were the natural limitations of any turbine-powered conventional fighter. Thin armor, plus limited fuel and ammunition, forced 'MechBusters to return to airstrips frequently for re-arming and re-fueling. Even with other support craft to protect it and supply aerial refueling, the 'MechBuster only has enough ammunition to under a minute of continuous firing before it ran dry. Without VSTOL, it also requires a dedicated airstrip for it to land and take-off, precluding any ability to wage a guerrilla campaign. If the enemy captures the airstrip, 'MechBusters will have to be abandoned if no other base of operations can be procured quickly.

As a strike craft and interceptor, however, the 'MechBuster proved excellent. Its sole weapon, a Zeus 75 Class-20 Autocannon, provides a potential for it to destroy several BattleMechs before it needs to retire from the field. A squadron of 'MechBusters can turn the tide in a ground battle in the time it takes to run their autocannons dry. Also incorporated into the design is an advanced bomb targeting system, which allows external weapons to be targeted with ease.

Deployment

The Free Rasalhague Republic has been arming militias with dozens of 'MechBusters, and it seems the state cannot get enough of the fighter. In fact, the KungsArmé has been buying up used 'MechBusters that House Kurita retired since the production lines on Rasalhague cannot keep up. No other nation has expressed interest in the design, though a number of paranoid nobles looking to expand their private militias have purchased a few.

'MechBusters were so rare outside of the Draconis Combine that many do not believe they exist beyond that House's borders. However, the Lyran Commonwealth attempted a daring raid using a squadron of 'MechBusters (in Combine livery) and a company of BattleMechs on Kirchbach in 3025. The plan was to launch the fighters from an in-flight DropShip and then race to destroy a command bunker that would be housing several prominent ISF figures. The BattleMech company would then combat drop to capture a nearby airstrip, where the fighters would be recovered. After training in simulators for weeks on end, the raiding party left for Combine space, confident of their abilities.

The raid started off poorly. Four of the six 'MechBusters launched into a flock of migratory birds, wrecking their turbines and crashing. The other two went on to successfully destroy the bunker and killed most of the targets.

The 'Mech force hot-dropped on the planet but came across a militia unit that was several kilometers from its anticipated location. Low on fuel, the fighters had to land on the airstrip even while it was still in the defenders' hands. Amazingly, Combine-style flight suits and paintjobs convinced airstrip personnel that the 'MechBusters were reinforcements to help the militia, so the fighters were re-supplied and sent off. The 'MechBusters helped destroy the militia, recover the pilots of the four crashed 'MechBusters, and secure the landing strip before successfully escaping to Lyran space.

Variants

Units have tried alternate weapon loads in an attempt to lengthen the 'MechBuster's loiter time. One variant removes the autocannon for a trio of medium lasers and ancillary equipment, and adds fuel. Another uses four SRM 6 packs along with extra armor and fuel, but neither of these have the "one shot, one kill" capability of the original.

Upgrades

One newtech upgrade to the 'MechBuster replaces the Zeus-75 with an LB 20-X autocannon. The ability to fire solid or cluster shells adds to the 'MechBuster's utility, but the single ammunition bin forces the pilot to make their choice wisely prior to take off.

Notable Pilots

Michael Bergman: One of the surviving pilots of the Kirchbach operation, he still is amazed to this day that he was not captured during the desperate landing. With royalties from a best-selling holo vid based on his exploits in the Kirchbach operation, *The Bergman Raid*, Michael looks forward to a wealthy retirement from the LCAF.

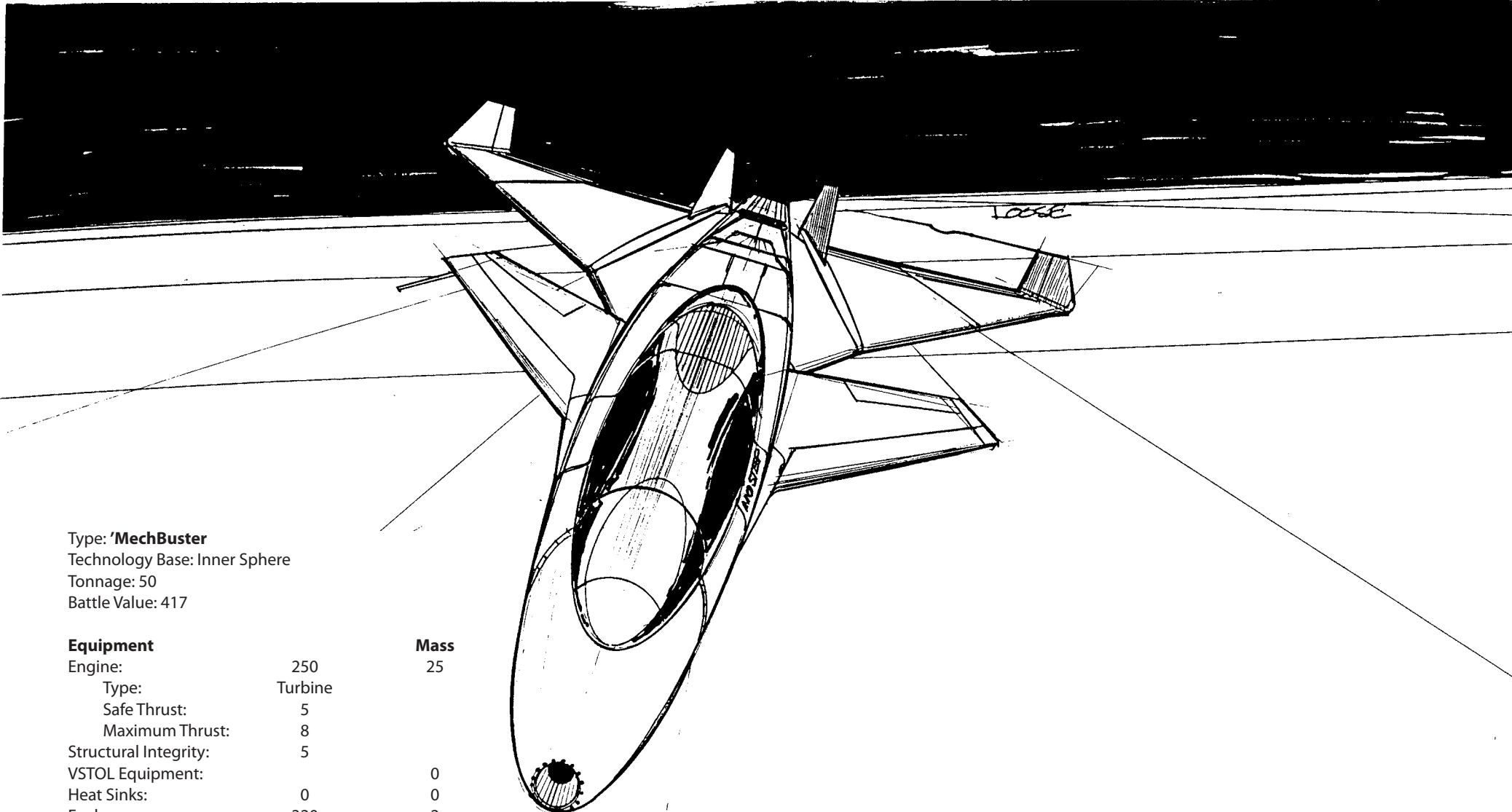

Type: **'MechBuster**
 Technology Base: Inner Sphere
 Tonnage: 50
 Battle Value: 417

Equipment

Engine:	250	Mass	25
Type:	Turbine		
Safe Thrust:	5		
Maximum Thrust:	8		
Structural Integrity:	5		
VSTOL Equipment:			0
Heat Sinks:	0		0
Fuel:	320		2
Cockpit:			5
Armor Factor:	48		3

Armor Value

Nose	18
Wings	10/10
Aft	10

Weapons and Ammo

AC/20
Ammo (AC) 5

Location	Tonnage	Heat	SRV	MRV	LRV	ERV
Nose	14	7	20	—	—	—
—	1					



Mass: 50 tons

Chassis: Imstar Type XI

Power Plant: GM 200 Turbine

Armor: Riese Reliable

Armament:

None

Manufacturer: Imstar Aerospace

Primary Factory: Marik

Communications System: Irian UHF

Targeting and Tracking System: None

Overview

The Planetlifter is a typical example of a conventional rough field military transport aircraft used by many military outfits. These craft are usually assigned directly to a planetary garrison commander, allowing them to quickly shift combat assets from one battlefield to another. This strategic mobility functions effectively as a force-multiplier, allowing a garrison to be spread out for population control and as a counter to small-unit raids but still able to concentrate quickly to blunt major assaults.

Capabilities

The Free Worlds League-produced Planetlifter can carry up to twenty-and-a-half tons of cargo in its lightly armored fuselage. Bulkheads dividing the bay are removable, allowing the aircraft to adjust for heavier and bulkier loads that cannot be stored conveniently in one bay or another.

The Planetlifter's loading procedures are unique among military transports its size. Vehicles and infantry can load in the normal manner via cargo ramps in the tail or the nose. Light 'Mechs can also be quickly and safely loaded onto the plane because the entire length of the upper fuselage detaches from the lower half. A Planetlifter lowers itself to ground level on its variable landing gear, detaches the lower fuselage, and then rolls away. The light 'Mech to be transported lies down on top of the now-exposed cargo bay floor and is secured by the ground crew. The aircraft then rolls back over the lower fuselage, attaches itself, and is ready to take off. An experienced crew can land, load a *Wasp*, and take off again in under fifteen minutes. Several militia units in Marik space even have "Loader Contests" every few years to see which crew can load a Planetlifter the fastest.

Deployment

Planetlifters can be found on practically every world within the Free Worlds League in service to the planetary militia. Due in part to the incredible daring and strategic acumen of Colonel Joseph Yetti during the battle of Autumn Wind, in which the 751st Jump Infantry Regiment destroyed a company of Steiner 'Mechs and captured a *Union*-class DropShip with the aid of a fleet of Planetlifters. Imstar Aerospace saw its production levels skyrocket after the battle in 3002. Because of its solid safety record and low maintenance engines, the Planetlifter remains a popular choice for many logistics officers. Imstar started to slow production in 3036 in anticipation of servicing existent units rather than selling them.

Heavy air transport planes are found on most worlds across the Inner Sphere, though most are not as militarized as the Planetlifter. The Lyran Walrus II—an improvement on DMI's ancient deathtrap design from the late 2300s—holds many similarities to Imstar's Planetlifter. The Davion SuperPelican, a licensed version of the Planetlifter, was phased out in 3029 when the license was revoked during the Fourth Succession War. The Combine, surprisingly, has three different air transport designs. Conspiracists theorize that the three Kuritan companies are really shell corporations for Wakazashi Enterprises.

The Capellan Yangtze design is uninspired, often called "the pucker plane" by AFFS soldiery. Stories are told by many Davion pilots who piloted captured Yangtzes during the Fourth Succession War, tales of shoddy maintenance, sudden dips and dives, hideous yaw problems, and vehicles that handle like a brick. According to these men and women, flying a Yangtze was akin to stepping off a cliff with a Taurian parachute—"puckering up" in anticipation of the possible failure of the poorly-made device. Nevertheless, these pilots performed heroically during the invasion of the Confederation, not only moving war materiel in a timely manner but also managing to airdrop supplies to civilians caught behind enemy lines.

Variants

The most common variant is the SuperPelican (dubbed the Waddle), which converts the transport into an airborne support platform. The Waddle mounts an SRM 6 one-shot in the nose and an autocannon/5 under each wing. However, poor ventilation tends to clog the converted bay with dense, choking smoke after a few seconds of firing.

Upgrades

With the Waddle's poor performance, no other upgrades of the design have been attempted.

Notable Crews

Captain Dagomar White: The commander of the two SuperPelicans assigned to the MIIO special forces that assisted Lindon's Battalion in a March 3039 attack of Bergman's Planet, Captain White lived as if he had something to prove. He flew his SuperPelican, "Stuart the Mad," through enemy fire and managed to bring back one team fully intact after being struck by an anti-air missile that destroyed over half of the Stuart's control surfaces. Though not a member of the MIIO, the captain received a small pension from the organization when he retired in 3040.

PLANETLIFTER AIR TRANSPORT

Type: **Planetlifter Air Transport**

Technology Base: Inner Sphere

Tonnage: 20

Battle Value: 143

Equipment

Equipment	Mass
Engine:	200
Type:	Turbine
Safe Thrust:	4
Maximum Thrust:	6

Equipment

Equipment	Mass
Structural Integrity:	5
VSTOL Equipment:	2.5
Heat Sinks:	0
Fuel:	320
Cockpit:	5
Armor Factor:	48
	3
	<i>Armor Value</i>
Nose	22
Wings	7/7
Aft	12

Weapons and Ammo

Weapons and Ammo	Location	Tonnage	Heat	SRV	MRV	LRV	ERV
Cargo	—	20.5					

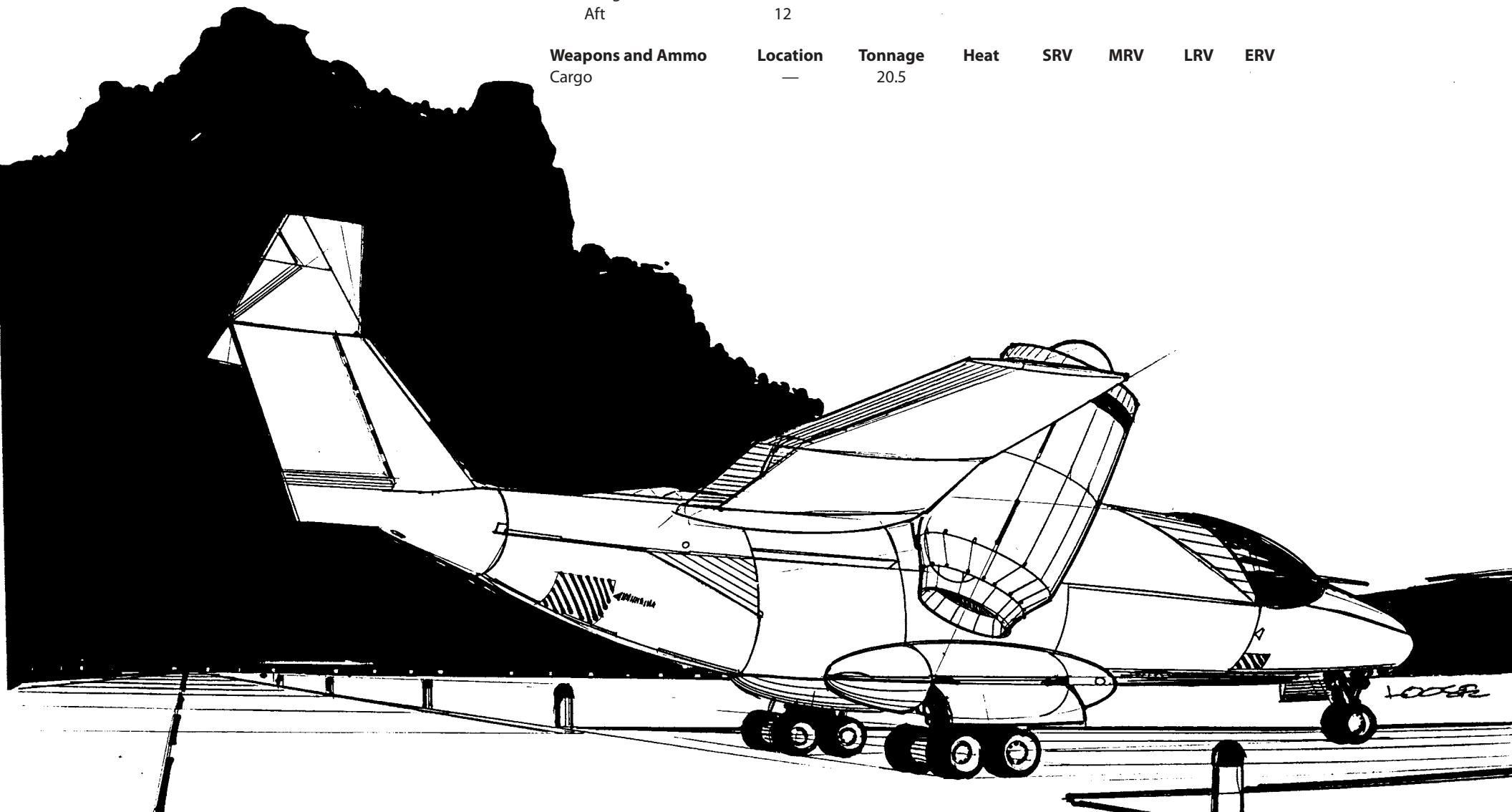

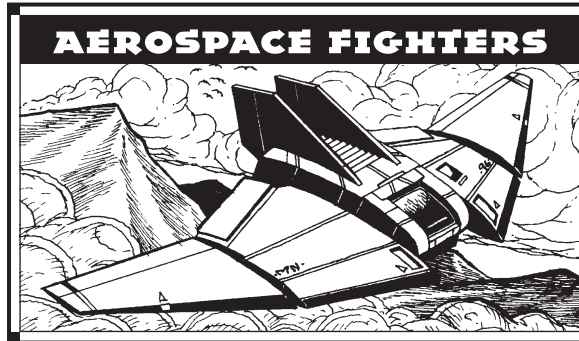

Aerospace fighters predate the BattleMech, having been introduced when Terran Alliance military commanders needed a means to cover their landing parties as they descended on a wayward colony from space. While orbital craft provided sufficient escort for transport shuttles, their inability to enter the atmosphere and effectively fight their air-breathing conventional fighter siblings necessitated the development of dual-role aerospace fighters, craft that have outperformed even their original designer's wildest hopes.

While sometimes treated as an afterthought, fighters still play a vital role in any battle plan. Not only serving as a more powerful and accurate artillery when performing ground-support operations, they also fill a guardian role against enemy fighters attempting to do the support their own troops. A force attempting to exploit a weak point can be beaten back with timely fighter support from squadrons that can traverse battlefields in mere seconds. Sometimes, victory can be secured without a shot when one side fields fighter support and the other side does not.

Critics will point out that an air combat force can neither take nor hold planetary ground—only boots on the ground can. While this is true, a well-trained and well-equipped air combat force often acts as a significant force-multiplier to a friendly ground unit, softening up (if not outright destroying) enemy units before the two armies on the ground ever make contact.

Nearly every BattleMech regiment contains several squadrons of aerospace fighters for various duties including intercepting enemy transports, deep-space escort, and ground support. Their pilots have held onto a degree of honor and nobility rivaled only by their ground-based cousins, the BattleMechs. In fact, in House Davion, there was once a major rivalry between the two arms of the military when people began idolizing the aerospace pilots over the MechWarriors.

[EDITOR'S NOTE: Victor, previous Technical Readouts have not mentioned the upgraded versions of aerospace fighters that have come out in the past twenty years. So for the sake of ease, instead of going back and attempting to distribute errata and amend those files, I have instead included the updated versions in a small section called "Upgrades." I have also included in this section the *Samurai*, a fighter that has been overlooked for some time. —Focht]

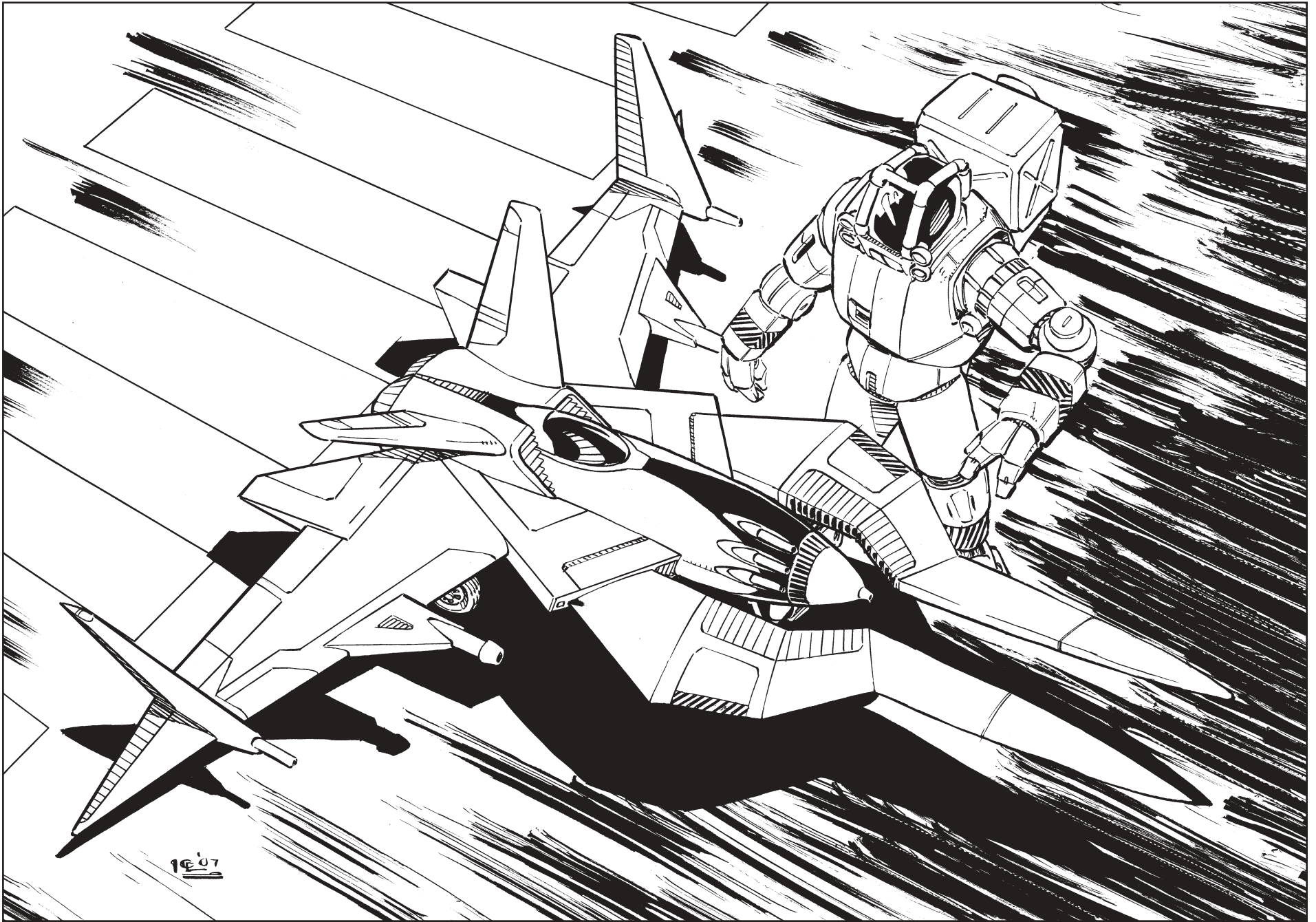



Mass: 20 tons

Chassis: Shipil 15

Power Plant: Shipil 180

Armor: Shipil Standard

Armament:

1 RamTech 1200 Large Laser

Manufacturer: Shipil Company, United Outworlders Corporation, Taurus Territorial Industries

Primary Factory: Skye (Shipil), Ramora (UOC), Sterope (TTI)

Communications System: O/P AIR500

Targeting and Tracking System: O/P 3000

Overview

Answering a bid for a swift interceptor with heavy-hitting firepower, the *Seydlitz* handily won the contract and has won many more since entering mass production in 2504. Unfortunately, every other feature of the fighter was given minimal consideration, and the Succession Wars have not been kind to this niche design.

Capabilities

The idea behind the *Seydlitz* was hitting an enemy target fast and hard in hopes of destroying them before they can return fire. Its Shipil 180 engine takes up over a third of the craft's weight, giving it considerable thrust and the ability to rapidly intercept an invading force. A single, nose-mounted RamTech large laser can often eviscerate other fighters without ablating large swaths of armor. Small DropShips fear the *Seydlitz*, as the fighters can swiftly get behind the DropShips to maul vulnerable drives and engineering systems.

However, only two tons of armor clad the *Seydlitz*, allowing virtually any weapon to penetrate on the first volley. Many *Seydlitz*s are fearful of ambushes, because without the first shot there is a high chance that the fighter will be disabled within the first critical seconds of a battle. And with only three tons of internal fuel capacity, the *Seydlitz* cannot stray far from a friendly DropShip or airstrip, forcing it to make only a few attack runs before having to return. Though more fuel can be mounted on hard points, up to an additional two tons, this slightly hampers the fighter's maneuverability. On such an agile fighter as the *Seydlitz*, the effects are more psychological than real, but pilots will still often eject fuel tanks when entering combat.

Deployment

At the turn of the century, manufacturers in both the Outworlds Alliance and the Taurian Concordant approached Shipil seeking permission to produce the light fighter. Since neither nation was actively opposing House Steiner at the time, both were granted licenses for nominal fees and royalties, and production quickly followed. Since the beginning of the Federated-Commonwealth Alliance and the Fourth Succession War, the alliance has encountered *Seydlitz*s when Davion units patrol border worlds in the Periphery.

Variants

Looking to expand on its key advantage, Shipil created the Z2, replacing the large laser with five medium lasers spread out over the wings and nose.

A more conservative Z3 configuration produced by Shipil attempted to turn the *Seydlitz* into a better dog-fighter. Only two medium lasers are mounted, one in each wing. The rest of the tonnage is put into the armor, giving the fighter roughly double its original protection. However, the additions are crude and have left vulnerable areas.

Upgrades

In an attempt to solve the *Seydlitz*'s flaws, Shipil used advanced technology on all the various fighter configurations to make the design more appealing to units. The newer models all used double heat sinks, extra-light fusion engines, additional armor of advanced ferro-aluminum composites, and, importantly, extra fuel. The Z4 replaces the large laser with an extended-range version. The Z2A still carries just five medium lasers, though a more recent Z2B replaces four of them with extended-range models and a ton more armor than its 3050 predecessor. The Z3A variant, popular only when dogfighting with other light fighters, carries a pair of medium pulse lasers and four-and-a-half tons of ferro-aluminum armor.

As a minor point of note, right after the Lyran Alliance seceded, Shipil yards began putting out limited Z1 models for poor factions inside the Chaos March. Identical to the original 21 Model, this was basically a name change and public relations move to bring the fighter designations in line with one another. Both the Taurian and Outworlds licensees have done the same to honor their contractual agreements.

Notable Pilots

Leutenant Arne LeSat: Hailing from a minor noble family on a backwater Lyran world, Arne LeSat is one of the newest scout fighter pilots in the Twenty-fourth Lyran Guards. A vocal critic of the Steiner-Davion alliance (often derided behind his back as a "Steiner supremacist"), LeSat nonetheless proved to be an exceptional pilot who is equally at home in air-to-air combat as he is in leading strafing runs against ground targets. Though he did not see live combat until 3039, LeSat's pre-war simulator record credited him with over a dozen unassisted 'Mech, vehicle, and fighter kills after his academy graduation (including the spectacular splashing of his combat flight instructor, Fourth Succession War ace pilot Hermann Scheere).

SYD-21 SEYDLITZ

Type: **Seydlitz**

Technology Base: Inner Sphere

Tonnage: 20

Battle Value: 440

Weapons and Ammo

Large Laser

Location

Nose

Tonnage

5

Heat

8

SRV

8

MRV

8

LRV

—

ERV

—

Equipment

Engine:	180
Safe Thrust:	11
Maximum Thrust:	17
Structural Integrity:	11
Heat Sinks:	10
Fuel:	240
Cockpit:	3
Armor Factor:	32

Mass

7

Armor Value

Nose	10
Wings	6/6
Aft	10

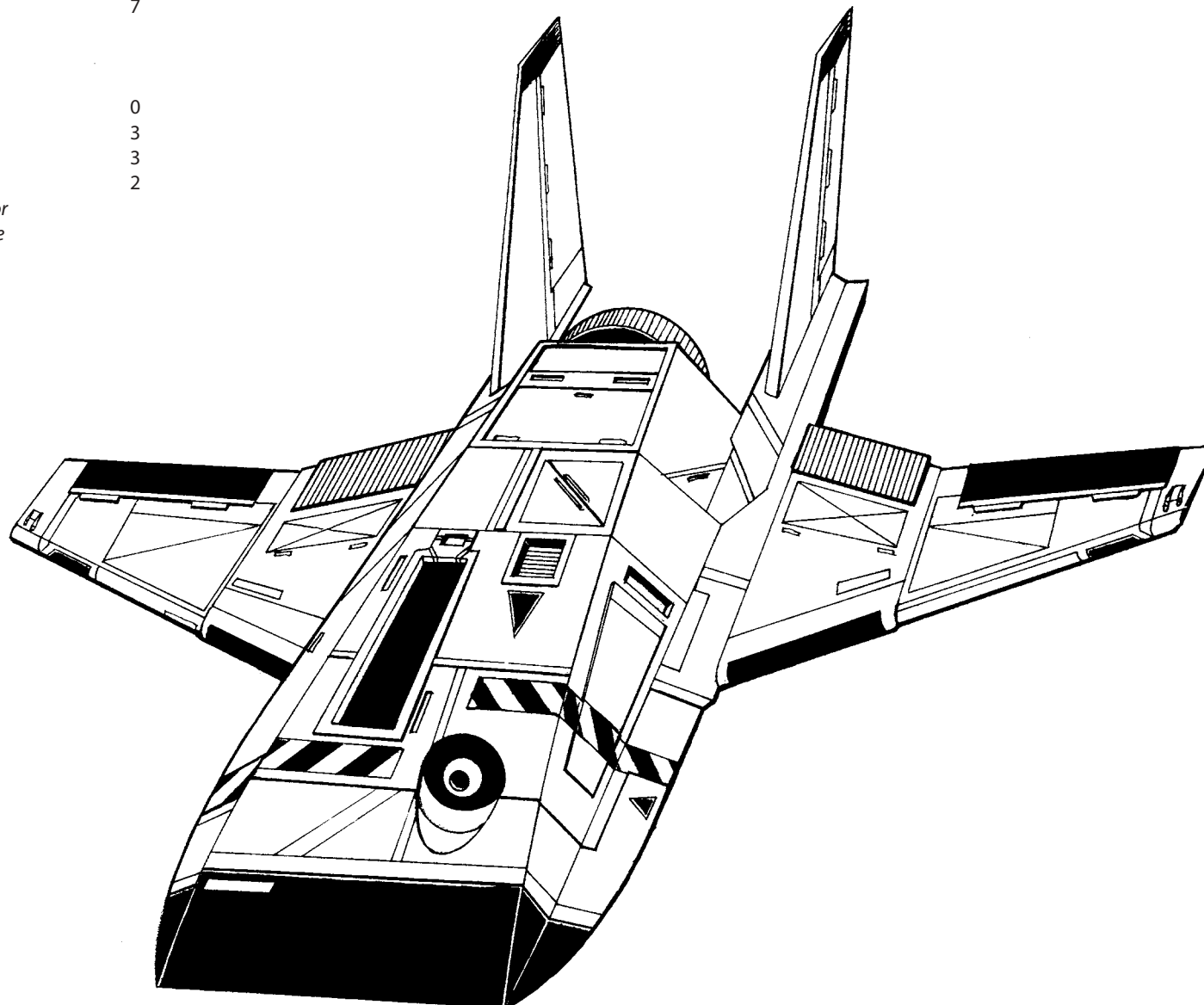



Mass: 25 tons

Chassis: Imstar 10/f

Power Plant: GM 250-a

Armament:

1 Starflash I Small Laser

2 Starflash II Medium Lasers

Manufacturer: Imstar Aerospace

Primary Factory: Atreus, Amity, Marik

Communications System: Lassitor—3QS

Targeting and Tracking System: IMB SYS 3600

Overview

A Marik variant on an old Star League design, the *Cheetah* is a swift, lightly armored aerospace fighter intended for fast strikes and reconnaissance missions. Designed by Imstar Aerospace, the fighter was in production up until the fall of the Star League. After the Exodus, the Free Worlds League picked up production of the *Cheetah* and, after retooling several factories to produce the fighter, it became the standard light fighter of the Free Worlds League Military.

Capabilities

With a maximum acceleration of nine gravities, the *Cheetah* is one of the fastest (and most physically punishing) aerospace fighters in the Inner Sphere. The *Cheetah* needs this acceleration, however, because it is very lightly armored. The original SLDF craft relied on speed for protection, and the Marik production model is the same.

Its armament is capable for a fighter of its size. One small and two medium Starflash lasers free the *Cheetah* from ammunition concerns and give it the firepower to engage other fighters once its speed has given it the advantageous position. The *Cheetah* functions as well in atmosphere as it does in space, although there is apocryphal lore that claims the *Cheetah* is difficult to control in atmosphere and that the GM 250-a drinks more than the usual amount of fuel.

Deployment

In continuous production since the fall of the Star League in the Free Worlds League, the *Cheetah* appears in almost every Marik aero formation. Most planet-bound squadrons keep *Cheetah* fighters ready for recon or interdiction duties, and it flies from most orbital platforms. Many Marik assault DropShip squadrons keep *Cheetah* flights in reserve for long-range patrolling or fast courier runs.

Variants

The 11-R *Cheetah* is a dedicated reconnaissance version of the fighter, which removes the medium lasers and adds two more tons of fuel to give the *Cheetah* tremendous legs. With its radical acceleration profile, few craft can catch a retreating *Cheetah*, although the stress on the pilot is tremendous.

The 12-S *Cheetah* is an attempt to provide a swift strike fighter. The medium lasers are removed in favor of an SRM 4, and a ton of fuel is removed to make room for the missile reloads. With its reduced fuel capacity the 12-S needs a ready resupply base, which means it is rarely found away from orbital installations or a DropShip carrier.

Upgrades

The standard F-11 production model corrects many of the F-10's flaws. Using a GM 250-a XL-engine, the armor mass is increased by half and upgraded to ferro-aluminum, while the lasers are upgraded to pulse models. Two tons of fuel are added, making the F-11 a well-rounded fighter.

The newer-production F-11-RR *Cheetah* also uses an extralight engine and adds back in the medium lasers. The shining star of the upgrade, however, is the increased ten-ton fuel capacity. The 11-RR variant has legs *and* teeth.

An upgrade of the 12-S, the 14-S *Cheetah* mounts twin Streak 2 packs and slightly less armor.

The most recent *Cheetah* variant, the F-13, upgrades the lasers to ER models with an extra medium laser added to each wing. Double heat sinks keep the heat curve manageable, while heavy ferro-aluminum armor provides even more protection to the craft.

Notable Pilots

Captain Diane "Vixen" Virgil: Captain Virgil's double-squadron mercenary fighter unit has operated for every Successor State and two Periphery nations. Consisting of a full squadron each of *Cheetahs* and *Sabres*, Captain Virgil's unit excels at fast-strike or interception duties. They often fight as squadrons rather than single fighters, with the whole group making a single high-speed slashing attack and then continuing on course to withdraw while the enemy regroups, allowing themselves to reform into another cohesive unit for Vixen and her fighters to destroy.

Her squadron uses the ancient skull and crossbones as their insignia, and outside of the cockpit her pilots carry cutlasses in addition to pistols. More than once a bar brawl has begun—and quickly ended—when someone makes fun of the swords, which every pilot is trained to use.

Pilot Marco Archibaldi: Pilot Archibaldi is a *Cheetah* pilot in the Fusiliers of Oriente. His fighter, "*Swiftly*," is routinely giggered at in inspections for unauthorized nose art. Archibaldi is an accomplished artist and likes to spend his alert time near his fighter, using the broad canards on the *Cheetah's* nose as a canvas. Several of his paintings have been holographed before being removed and sent to various art museums on and around Oriente, where they have sold for healthy sums. He uses this income to spend whatever leave time he can as far away from his fighter as possible and spend some time with real canvas.

F-10 CHEETAH

Type: **Cheetah**

Technology Base: Inner Sphere

Tonnage: 25

Battle Value: 448

Weapons and Ammo

Weapons and Ammo	Location	Tonnage	Heat	SRV	MRV	LRV	ERV
Small Laser	Nose	.5	1	3	—	—	—
Medium Laser	RW	1	3	5	—	—	—
Medium Laser	LW	1	3	5	—	—	—

Equipment

Equipment	Value	Mass
Engine:	250	12.5
Safe Thrust:	12	
Maximum Thrust:	18	
Structural Integrity:	12	
Heat Sinks:	10	0
Fuel:	320	4
Cockpit:	3	3
Armor Factor:	48	3
<i>Armor Value</i>		
Nose	13	
Wings	11/11	
Aft	13	

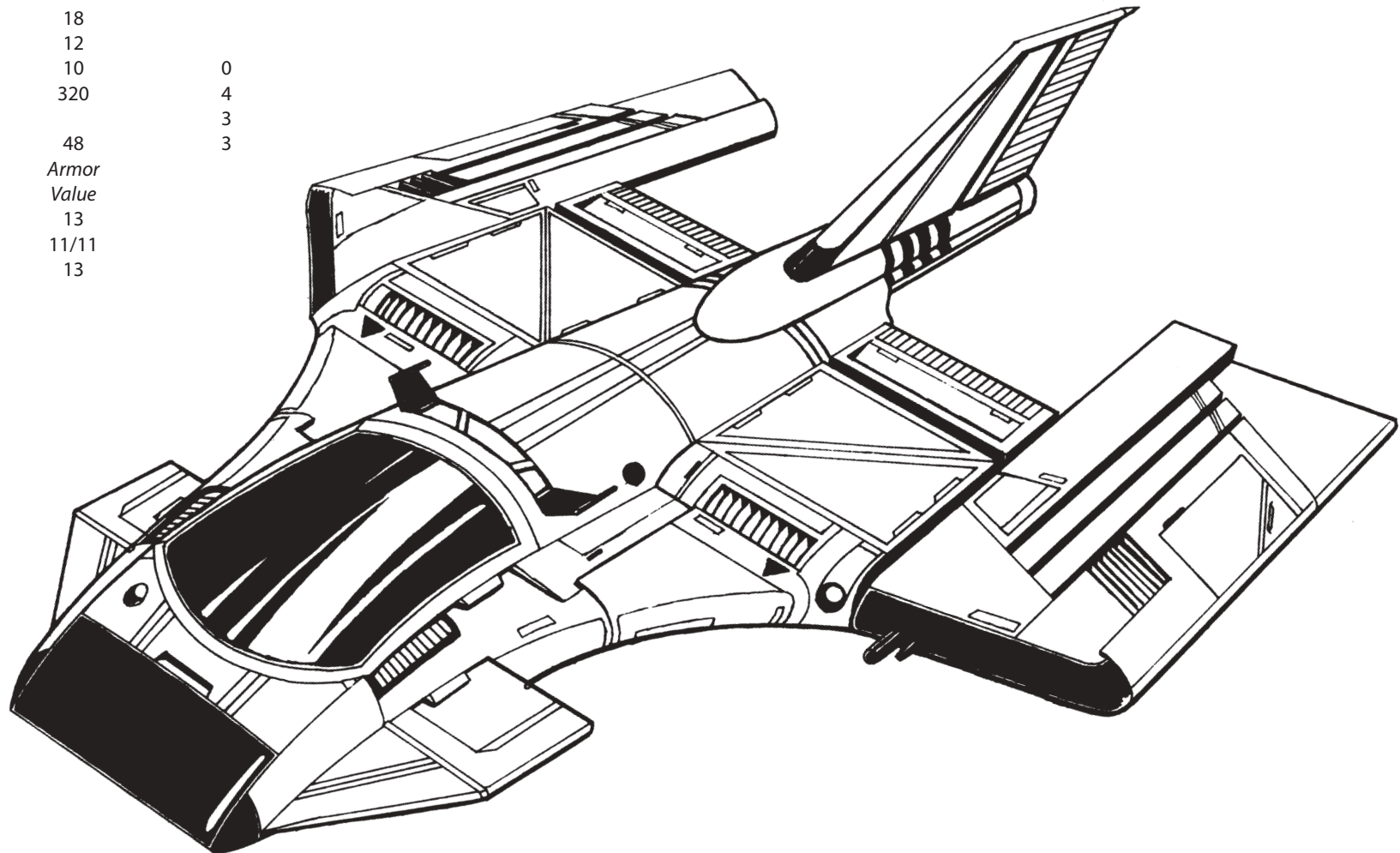



Mass: 25 tons

Chassis: Mujika Aerospace Type 12

Power Plant: Rawlings 250

Armor: Starshield

Armament:

3 Kajuka Type 2 "Bright Blossom" Medium Lasers

Manufacturer: Mujika AeroSpace Technologies

Primary Factory: St. Ives

Communications System: Endicott Type 22 Maser

Targeting and Tracking System: Dwyerson Mark XI

Overview

Originally developed by Mujika AeroSpace in 2798, the fighter's advanced Type 12 frame allowed the fighter to withstand the severe acceleration forces inflicted on it by its Rawlings 250 power plant. Efficient and deadly, the Capellan Confederation found the craft to be an outstanding escort and interceptor, and quickly ramped up production to phase out its more ancient light fighters. It remained in general service with the Confederacy until the creation of the St. Ives Compact. The *Thrush* is very popular among pilots for its excellent maneuverability, although many regret the craft's relative lack of firepower and armor compared to the heavier interceptors in common use.

Capabilities

As one of the most agile fighters deployed among the Successor States, the *Thrush* is capable of outrunning anything it can't outgun. Armed with three Kajuka Type 2

lasers, the *Thrush* is capable of causing substantial damage to hostile light fighters, and heavier, less maneuverable fighters often find themselves defeated by the swifter craft unless they have rear-firing weaponry. For all its impressive capabilities, the craft's dominance is severely restricted, as even the lightest of weapons and individual missile strikes can result in substantial damage to the internal components of the fighter.

An additional substantial drawback for the *Thrush* is its tendency to enter uncontrolled spins during atmospheric operations. Pilots usually regain control over the craft swiftly, but the time lost during this effort often allows their prey to shake pursuit. *Cheetah* pilots in particular have learned to use this effect, leading pursuing *Thrushes* in and out of the atmosphere as much as possible, sniping during the moments of uncontrolled behavior. It is widely presumed that the spins are a consequence of the craft's circular wing design, which also plagues the Combine's *Sholagar*.

Deployment

The *Thrush* remains one of the most common fighters in the Confederation's arsenal. The Capellans do not currently seem to have any plans to find a replacement for the *Thrush*. [EDITOR'S NOTE: The reclamation of the St. Ives Compact ended the Capellan's light fighter dilemma.] The Compact meanwhile swelled the ranks of its aerospace fighter formations with the capable *Thrush* and was soon exporting excess production to interested buyers, House and mercenary alike, which has resulted in the fighter appearing in small numbers across the Inner Sphere.

Variants

There are no official variants of the TR-7.

Upgrades

Mujika Technologies petitioned the St. Ives Compact for access to medium pulse lasers for use on a model that sacrificed a ton of fuel in order to mount two such weapons. This undesignated variant was never identified in production before the Confederation reclaimed the Compact. In 3065, the Confederation minimally improved the *Thrush*,

producing the TR-8. This upgraded the heat sinks and replaced the lasers with extended-range versions. Plans for an XL-powered *Thrush* with much heavier armor and weapons never left the cash-strapped Confederation's design software before the Jihad broke over the Inner Sphere.

Notable Pilots

Captain Jack Winfield: "Smiling" Jack Winfield is one of the most decorated and renowned *Thrush* pilots in the Confederacy. Feared along the Davion border, Winfield was credited with dozens of kills until he was re-assigned to the Sian Aerospace Training Command. He was re-activated for frontline duty during the Fourth Succession War, where he was quite successful. Winfield was placed on a long list of military personnel to be demoted for their "failures" in that war, a blessing given how many on the list were purged instead. Chancellor Romano Liao recognized the value of Winfield, who kept serving loyally even after being demoted, and gave him his own squadron in time for the Andurien Invasion. Captain Winfield found many opportunities to prove the wisdom of her decision and regain his rank.

Subcommander Marina Layton: Much like another famous *Thrush* pilot, Uchita Tucker, Layton seems to have dedicated her life to the pursuit of aerospace combat excellence. A bit of a maverick, Layton has been reprimanded several times for interpreting her orders liberally to allow her to engage hostile fighters. While her squadron can rely on her to not jeopardize them or the mission, her behavior has hampered her career. This does not appear to bother Layton, who seems focused on being an instrument of destruction. This singular focus has led to increasingly widespread rumors in her unit that she is a part of the vicious Thuggee cult, much like Uchita Tucker. The cult attracted substantial negative attention to itself when they proclaimed Kali Liao as an avatar of their goddess and began ritualistic murders to honor her.

TR-7 THRUSH

Type: **Thrush**

Technology Base: Inner Sphere

Tonnage: 25

Battle Value: 476

Weapons and Ammo

Medium Laser

Location

Nose

RW

LW

Tonnage

1

1

1

Heat

3

3

3

SRV

5

5

5

MRV

—

—

—

LRV

—

—

—

ERV

—

—

—

Equipment

Engine: 250

Safe Thrust: 12

Maximum Thrust: 18

Structural Integrity: 12

Heat Sinks: 10

Fuel: 400

Cockpit: 3

Armor Factor: 24

Mass

12.5

Armor Value

Nose 7

Wings 6/6

Aft 5

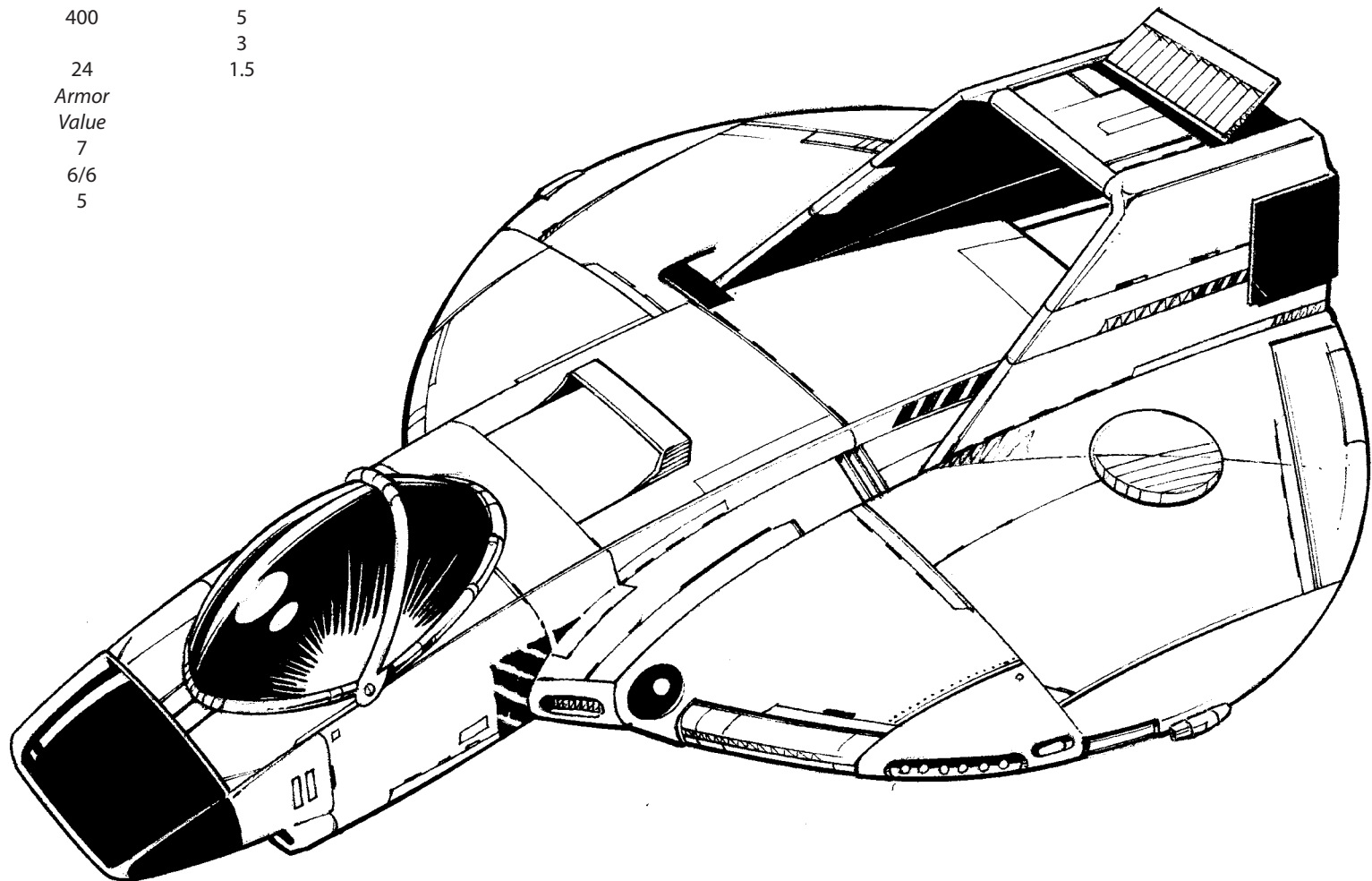



Mass: 30 tons

Chassis: StarTech Model II

Power Plant: Warner 240J

Armor: Carbondale II

Armament:

2 Martell Medium Lasers

2 Exostar Small Lasers

Manufacturer: Jalastar Aerospace

Primary Factory: Panpour

Communications System: Rander 100

Targeting and Tracking System: Rander TA4

Overview

Entering service with the Terran Hegemony as an escort fighter in 2520, the *Sparrowhawk* was not without its teething troubles. By the start of the Reunification War, however, Warner Incorporated had resolved most of the issues. During that conflict, the newly-formed Star League pressed the *Sparrowhawk* into service as an interceptor.

With the collapse of the Star League, the Federated Suns took control of Quentin and the *Sparrowhawk* production lines. House Kurita bombed Quentin during the First Succession War, destroying Warner Incorporated and forcing House Davion to relocate production to Panpour.

Capabilities

Early *Sparrowhawks* exhibited severe flaws in the airframe and fuel tank. Several fighters broke up in the atmosphere, and the fuel tank, situated under the pilot's seat, could rupture and allow hydrogen to seep into the cockpit. The H5 introduced a completely re-designed airframe, and a fuel venting system was added.

The *Sparrowhawk's* ample armor matches many medium fighters. One unique feature of the Carbondale II armor is the provision of a manual release system. Any plate of the armor that is so badly damaged that it would inhibit atmospheric re-entry can be ejected.

Armed with two small and two medium lasers, the *Sparrowhawk* is comparable to other light fighters. Combined with a high rate of thrust, this all-energy-weapon loadout makes the *Sparrowhawk* a perfect first-response craft.

The Rander TA4 communications system is one of the most reliable found on any aerospace fighter.

Deployment

Since the start of the Succession Wars, the *Sparrowhawk* has become the mainstay of the Federated Suns light aerospace forces. A popular choice for air lances in AFFS line regiments, *Sparrowhawk* squadrons also form the first line of defense for most worlds in the Federated Suns.

In 2901, House Kurita's Eighth Sword of Light was on final approach for a combat drop onto the Davion planet Errai. Just as their fighter screen engaged Errai's defenders, Davion reinforcements arrived. *Sparrowhawks* attacked the dropping 'Mechs while Davion heavy fighters tore through the DropShips. Suffering appalling casualties, the Kurita forces aborted the raid and hastily withdrew.

In 2952, Liao forces sought to take the planet Lee from House Davion. The space battle lasted nearly eight days and became known as "The Great Lee Turkey Shoot." *Sparrowhawks* assigned to Lee's defense suffered only a handful of losses compared to the dozens of Liao fighters destroyed.

ComStar used *Sparrowhawks* from its vast hidden cache of equipment to outfit the Com Guards. In 2979 a covert force was sent to destroy the derelict WarShip *Tripitz* before Taurian Concordat forces could salvage the vessel. The Com Guards succeeded, and the appearance of their unmarked white fighters gave rise to the legends of the Vandenburg White Wings.

Over the centuries *Sparrowhawks* have been captured by House Kurita. In 3019, a Davion force near Harrow's Sun encountered a Kurita battle group. Both sides automatically launched fighters, and the Davion forces were startled to learn that House Kurita possessed a version of the *Sparrowhawk*. The battle was inconclusive.

Variants

House Davion's Capellan March Militia operates the 8H, a version of the *Sparrowhawk* modified to carry one Holly SRM 2 pack and one small laser. Although it carries an extra half-ton of armor, the fighter is not popular with pilots, who find it under-gunned.

House Kurita's *Sparrowhawks* carry six small lasers mounted on the nose and wings. These extra weapons tax the targeting system, resulting in accuracy issues.

Upgrades

Jalastar Aerospace used data from the Helm Memory Core to create the SPR-6D *Sparrowhawk*. Upgrading the lasers with pulse technology, the fighter is protected with eight tons of ferro-aluminum armor, and the fuel tank has been expanded by forty percent. The installation of a GM 240XL power plant frees up the mass for the updates.

Another variant that appeared during the FedCom Civil War was the SPR-7D. It replaces the small pulse lasers of the 6D with extended-range medium lasers and upgrades the cooling system to use double-efficiency heat sinks.

Notable Pilots

Lieutenant Robard Miller III: Miller's grandfather, the first Robard Miller, was a well-known and decorated warrior until his death in 2960. He took part in the Great Lee Turkey Shoot and was credited with over forty kills. Miller's father then served as a wing leader with the Crucis March Militia and was credited with over fifty kills before his retirement in 3017. Robard Miller III has since taken over the family tradition and has served House Davion with distinction during both the Fourth Succession War and the War of 3039, claiming twenty kills.

SPR-H5 SPARROWHAWK

Type: **Sparrowhawk**

Technology Base: Inner Sphere

Tonnage: 30

Battle Value: 637

Weapons and Ammo

2 Medium Lasers

Small Laser

Small Laser

Location

Nose

RW

LW

Tonnage

2

.5

.5

Heat

3

1

1

SRV

5

3

3

MRV

—

—

—

LRV

—

—

—

ERV

—

—

—

Equipment

Engine: 240

Safe Thrust: 10

Maximum Thrust: 15

Structural Integrity: 10

Heat Sinks: 10

Fuel: 400

Cockpit: 3

Armor Factor: 120

Armor

Value

Nose 38

Wings 24/24

Aft 34

Mass

11.5

0

5

3

7.5

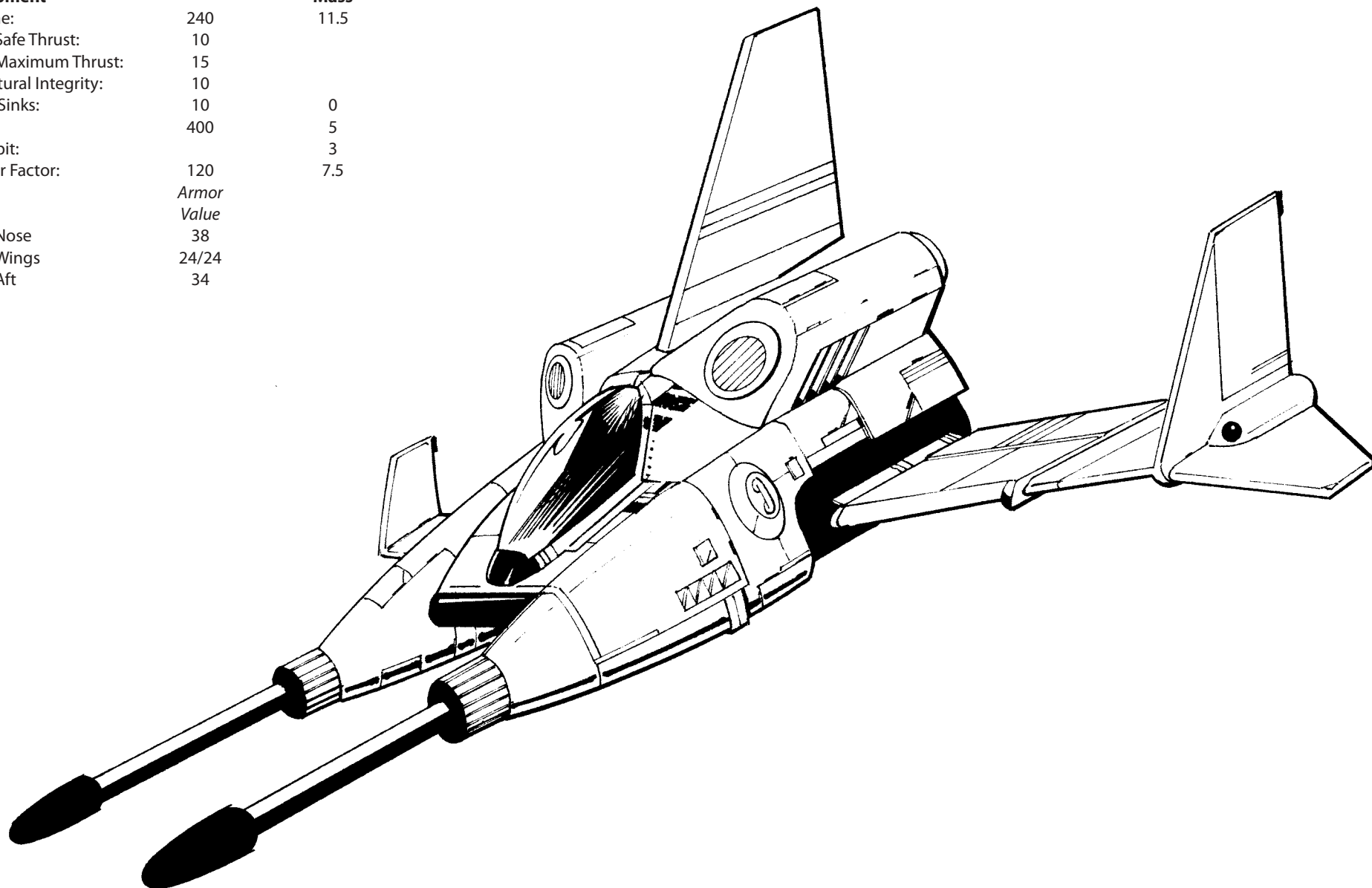



Mass: 35 tons

Chassis: Mangon Mark II

Power Plant: Shinobi 280

Armor: UC 451 Carbide

Armament:

1 Hovertec Short Range Missile Four-Rack

2 Diverse Optics Type 20 Medium Lasers

Manufacturer: Mangon Aeronautics

Primary Factory: Schuyler

Communications System: Neil 4000

Targeting and Tracking System: Chichester ASR-26

Overview

Looking for a new fighter to replace the aging *Star Dagger* and *Swift* fighters for the 29th century, Mangon Aeronautics supplied a quick solution for a solid fighter to the Combine. Later used as the base for the Capellan *Thrush*, the airframe was small and fit well into transports, but its circular wings were unstable in atmospheric flight, resulting in many crashes. Studies were hushed until the 3002 death of Coordinator Hohiro Kurita's nephew Akiro. Despite this, demand has kept the *Sholagar* in production, but the fines and penalties levied against Mangon combined with poor business practices led to their takeover by Wakazashi Enterprises in 3045.

Capabilities

The *Sholagar* is a light fighter meant for combat. The light fighters of other Houses are a bit faster but have less armor and firepower than the *Sholagar*. Over the centuries,

the *Sholagar* has even matched up well with the Federated Suns' medium fighter of choice, the *Corsair*, when handled with care. Due to the design, the *Sholagar* is better in space than atmosphere but isn't nearly as fragile as units with wider wingspans.

During a raid on Dobson, the *Sholagar* showed that it could be successfully used in atmospheric operations. Kuritan forces dropped outside Dobbiville unopposed, but FedSuns forces entrenched themselves in the city. As the ground forces advanced, four *Shilones* and eight *Sholagars* hit the city. As the *Shilones* strafed the armor units, the *Sholagars* bombed the 'Mech forces, drawing them away from the warehouse district. One *Shilone* was shot down while another returned to the ship damaged. One of the *Sholagars* lost control and crashed in the city, but the rest distracted the Davion anti-air forces, allowing the Kuritan ground forces to approach unopposed.

The *Sholagars* strafed Davion air defense armor, but it was their missiles that did the most damage, jamming turrets and demolishing vulnerable motive systems. Combine ground forces penetrated the warehouses and raided vital supplies. When the Davion forces finally wised up to the raid, the Combine forces were able to withdraw under cover from the remaining *Sholagars*. Most of the fighters returned to the DropShip after destroying over half of the anti-air company.

Deployment

The *Sholagar* is rather common throughout the Draconis Combine and rarely found anywhere else. A few space-based groups have managed to acquire some of the model, but most units would just as soon have a unit that is easier to control in atmosphere. *Sholagars* are common on DropShip escort duty and in units that are often on the offense.

Variants

Some pilots prefer more lasers than missiles and replace their Hovertec with another pair of Type 20s in the nose. An additional heat sink attenuates the heat issue, but care must still be used when firing all of the lasers at once. This variant, the -21L, is better at longer raids and ground support.

Upgrades

With the loss of the *Sholagar* and *Sai* factories on Schuyler in 3050, the low-tech *Sholagar* was brought back into limited production on Dover to prevent an over-reliance on foreign-built fighters. Due to its unpopularity, the *Sholagar* did not receive any new technology or upgrades before 3070. In the SL-22, designers used a light fusion engine and crafted six-and-a-half tons of ferro-aluminum armor into a more stable wing configuration. The SRM launcher was replaced with a seven-tube multi-missile launcher and the lasers were upgraded to ER versions. Double heat sinks make heat worries a thing of the past. Upgrade packages have been sent out as well, using the advanced armor, heat sinks, and lasers, enabling SL-21s to be upgraded to the SL-22 standard.

Notable Pilots

Chu-i William "Spike" Stern: A quiet pilot with the Third Sword of Light, Spike is probably the best light fighter pilot in the unit. Almost bird-like in the air, his dogfights quickly turn into games of cat and mouse. His favorite tactic is to slip in and hit a larger fighter unaware and then run them out of fuel in a nape of the earth chase while other Combine flyers engage the depleted forces.

Sho-i JoJo Faust: People are often shocked that the gentle and shy Faust, who serves in the Third Benjamin Regulars, could have accumulated eighteen kills. His fellow pilots would beg to differ with the "shy" label, for on patrols he becomes talkative on a great many subjects, from bad vidshows to fission technology. Now in his second *Sholagar*, he has followed his own tradition by naming it "*Bloodline's Destiny*" after a poor-selling pulp novel he wrote when he was younger.

SL-21 SHOLAGAR

Type: **Sholagar**
 Technology Base: Inner Sphere
 Tonnage: 35
 Battle Value: 625

Weapons and Ammo	Location	Tonnage	Heat	SRV	MRV	LRV	ERV
SRM 4	Nose	2	3	6	—	—	—
Ammo (SRM) 25	—	2	—	—	—	—	—
Medium Laser	RW	1	3	5	—	—	—
Medium Laser	LW	1	3	5	—	—	—

Equipment		Mass
Engine:	280	16
Safe Thrust:	10	
Maximum Thrust:	15	
Structural Integrity:	10	
Heat Sinks:	10	0
Fuel:	400	5
Cockpit:		3
Armor Factor:	96	6
<i>Armor Value</i>		
Nose	30	
Wings	23/23	
Aft	20	

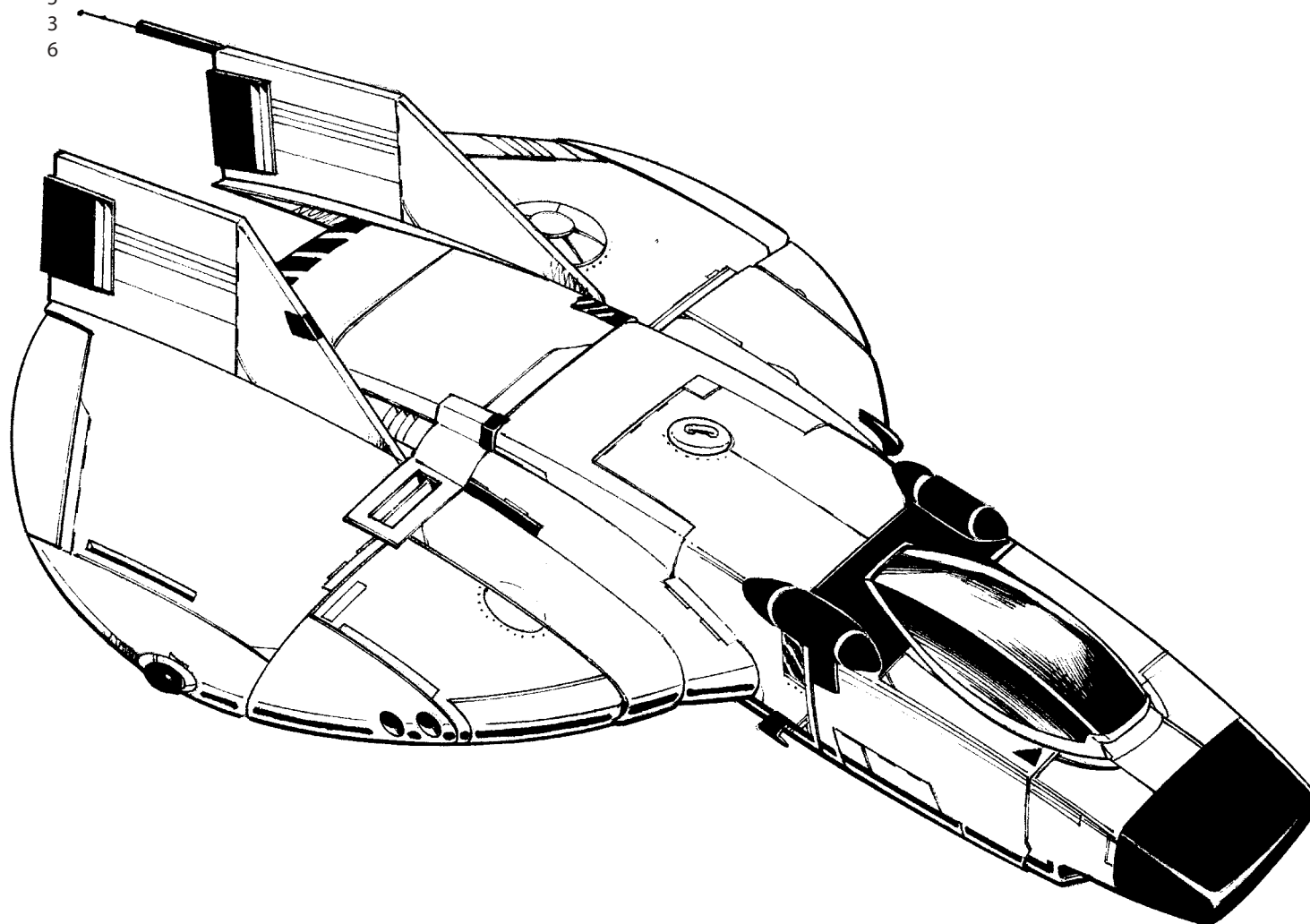

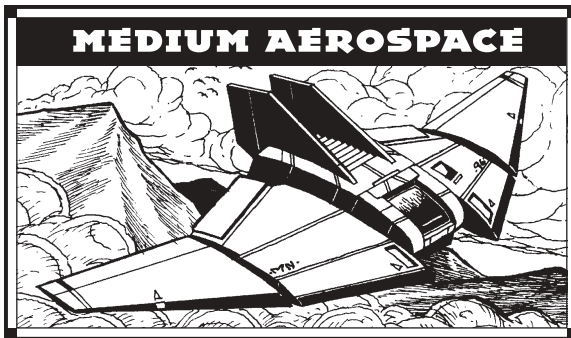

Mass: 50 tons

Chassis: Wangker II

Power Plant: GM 200

Armor: Wangker Corsair Standard

Armament:

- 2 Martell Medium Lasers

- 4 Exostar Small Lasers

- 2 Exostar Large Lasers

Manufacturer: Wangker Aerospace

Primary Factory: Axton

Communications System: Ranker 100B

Targeting and Tracking System: Ranker TA800

Overview

Looking to replace the horrific losses it suffered during the Amaris Civil War, the Star League Defense Force commissioned Wangker Aerospace to produce a new, easy-to-refit aerospace fighter. Within months, Wangker was producing the *Corsair*, a design that had been shelved in favor of a more advanced fighter. The fact that Wangker already had a working prototype when the SLDF approached them allowed the *Corsair* to proliferate quickly in the five years before Kerensky's exodus.

Despite the existence of a working prototype, the *Corsair* had many problems. Faulty life-support, rupturing fuel tanks, and defective landing gear would have killed most other projects, but the initial prototype's results were so good the Star League allowed the fighter into service while Wangker attempted to fix the difficulties.

Capabilities

The compact laser system and sleek shape has made the *Corsair* a superb aerospace fighter in atmosphere, rivaling many conventional fighters. The lasers, all eight of them, also give the fighter a lethal punch, making it dangerous to ground units. The thirteen-and-a-half tons of armor prevent many *Corsairs* from being destroyed by heavy return fire from enemy anti-aircraft units. To cool the energy weapons, sixteen heat sinks are mounted, allowing the two large lasers to fire continuously and the secondary medium and small lasers to fire with only marginal heat build up.

Deployment

House Davion, finding itself in possession of almost all of the *Corsair* lines, immediately began distributing it to its various aerospace units. It quickly became the favored medium fighter of the Federated Suns. Though some production facilities were destroyed, Wangker was able to rebuild the line on Axton using salvage from its other facilities. Though raided and damaged several times during the Succession Wars, Wangker has been able to repair and re-open the line every time.

When the Suns and Lyran Commonwealth merged, much debate occurred on what should be the fighter of choice, the *Corsair* or the *Lucifer* medium fighter. Several pilots of opposing viewpoints took to the skies to prove their craft, and despite the *Lucifer's* superior weaponry, the squadrons of *Corsairs* prevailed more often than not.

House Marik was able to capture a single *Corsair* line on Connaught. However, only several hundred were produced for the League military before the line was destroyed by the opening salvos of the First Succession War, and these eventually fell into the hands of the Principality of Regulus.

Variants

Very few variants of this popular fighter exist, due to pilots preferring the original configuration. Members of the Forty-second Avalon Hussars have removed the *Corsair's* secondary weapons for a single SRM 6 pack and have dubbed it the V20.

The Regular aerospace forces have attempted to preserve their handful of remaining *Corsairs*, the V12Ms, by removing a single large laser for several more heat sinks and more armor. Though this increases the *Corsair's* survivability, many dislike the reduction in firepower.

Upgrades

With so much money devoted to BattleMech upgrades, the *Corsair* received a minor facelift in the early 3050s. The V14 model gained double heatsinks, and swapped the large lasers for a pair of extended-range models. Nearly all *Corsairs* in the Davion side of space were V14s by the time of the FedCom Civil War, thanks to Wangker field refit kits.

A more modern version has appeared along with the latest round of new weapons and equipment. Emphasizing deadliness over cost effectiveness, the V18 mounts an extra-light engine and heavy ferro-aluminum armor. Mounting a pair of extended-range large lasers and a pair of light PPCs, the V18 is cooled by seventeen double heat sinks. The forward firing smalls are removed, while the rear ones are upgraded to ER models. Despite the disruption caused by the Jihad, many of these new *Corsairs* are making their way to Davion aerospace units with good reviews.

Notable Pilots

Major Robert Hatch: A member of the First Regular Hussars, Captain Hatch has frequently lobbied to acquire several more spare parts to keep the current fighters operational. While his request has repeatedly been denied, the alliance of House Davion and Steiner has made the probability of his request being granted more likely.

Type: **Corsair**

Technology Base: Inner Sphere

Tonnage: 50

Battle Value: 1,190

Equipment

Engine:	200	Mass	8.5
Safe Thrust:	6		
Maximum Thrust:	9		
Structural Integrity:	6		
Heat Sinks:	16	6	
Fuel:	400	5	
Cockpit:		3	
Armor Factor:	216	13.5	
		<i>Armor</i>	
		<i>Value</i>	
Nose	73		
Wings	50/50		
Aft	43		

Weapons and Ammo

	Location	Tonnage	Heat	SRV	MRV	LRV	ERV
2 Large Lasers	Nose	10	8	8	8	—	—
2 Small Lasers	Nose	1	1	3	—	—	—
Medium Laser	RW	1	3	5	—	—	—
Medium Laser	LW	1	3	5	—	—	—
2 Small Lasers	Aft	1	1	3	—	—	—

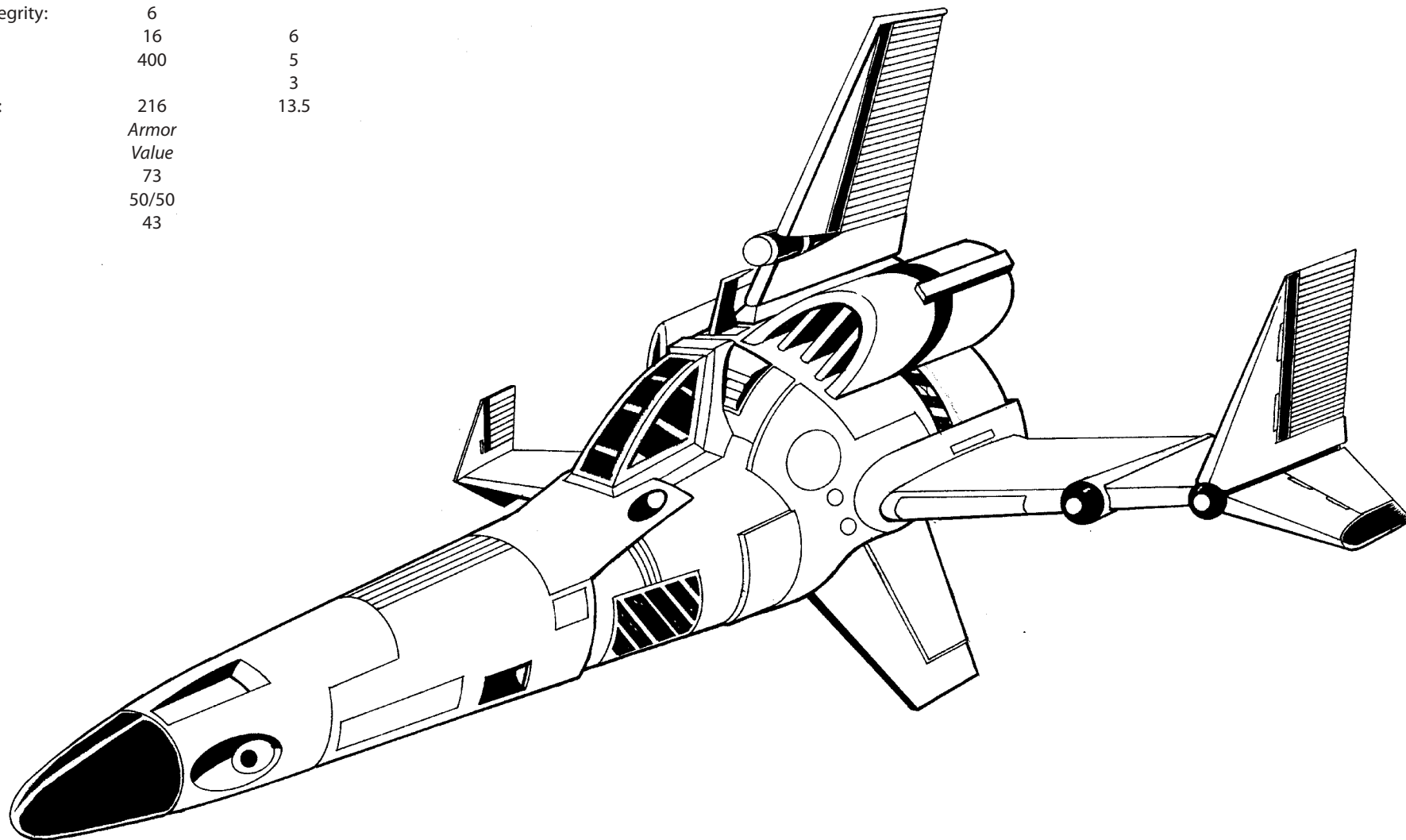

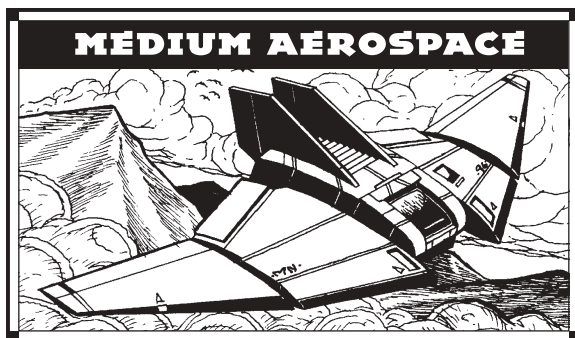

Mass: 50 tons

Chassis: FD 50-12

Power Plant: Hermes 250

Armor: SearWeave

Armament:

6 Maxell DT Medium Lasers

4 Magna Small Lasers

Manufacturer: Fairchild Dornier

Primary Factory: Mizar (destroyed 2774)

Communications System: FD 205

Targeting and Tracking System: Scope 115F

Overview

With the onset of the Age of War, the Terran Hegemony realized it needed an aerospace fighter that could devastate ground forces. When Fairchild Dornier proposed a design that offered speed, armor, and firepower, the Hegemony gave them a contract. The *Samurai* served well through Kerensky's Exodus, but the focus on ground support meant that the *Samurai* suffered more casualties than fighters with stronger air-to-air abilities. Amaris Coup battles on Mizar damaged the Fairchild Dornier plant so badly, they were limited to producing civilian commuter aircraft.

Capabilities

For its size, the *Samurai* has good speed and excellent armor protection. In its role as a ground-support unit, outright destruction rarely brings down a *Samurai*. Rather, solid hits may force a momentary loss of control, and no fighter has enough armor to withstand a collision with the ground. Against ground opponents, five forward-firing

medium lasers can be frightening, while against airborne opponents the firepower is impressive but the range is not. *Samurai* pilots use their speed to close with fighters of similar size or stay away from heavier fighters. When closing, three small lasers can be brought into play as well, increasing firepower by almost forty percent. The rear-firing lasers are handy in dogfights, keeping smaller fighters from sniping at the *Samurai's* rear. With eight tons of fuel capacity and no ammo requirements, the *Samurai* can stay in the field longer than almost any other fighter.

Deployment

Less than a few dozen *Samurais* have survived through the Fourth Succession War, many of them in poor condition. The high-maintenance frame requires specific parts that have to be handmade after the loss of the Fairchild factory. Interestingly, the highest concentration of *Samurais* can be found in the Outworlds Alliance, which suffered massive military losses inflicted by *Samurais* during the Reunification War.

Samurais were instrumental in foiling a large pirate raid on the Outworlds Alliance in 3020. Pirate forces sacrificed fighters to punch through Alliance defenses and land their ground units. Alliance ground forces were no match for the pirate 'Mechs, but they managed to keep the pirate forces bunched together. Clumsy pirate *Sholagars* couldn't match the atmospheric maneuverability of the *Samurais*, which crisscrossed the pirate units with strafing fire. As the pirates concentrated their fire on the fighters, Alliance ground forces pushed forward, catching their foes off guard. The cost was too high for the pirates, and they canceled the invasion.

Variants

After over a century and a half of quality service to the Hegemony, Fairchild Dornier redesigned the *Samurai* to take advantage the Star League's advanced technology. The SL-26 was equipped with an extra-light engine and ferro-aluminum armor. The wing-mounted medium lasers were upgraded to extended-range large lasers, while eighteen double heat sinks allowed pilots to safely strafe with all the forward-firing weapons. No SL-26 variants survived the Second Succession War.

Upgrades

Using profits from their civilian craft and subsidies from the Lyran Alliance and ComStar has allowed Fairchild Dornier to rebuild the *Samurai* line, though the current production is limited at the moment. Basing the new SL-27 off the SL-26, they have dropped three heat sinks to mount upgraded weaponry. For anti-air combat, a new plasma rifle with two tons of ammo can impair enemy operations. The laser selection consists of a pair of nose-mounted medium pulses, twin ER mediums and an ER small on each wing, and an aft-mounted ER small and ER medium. The Lyrans are very interested in the upgrades due to Blakist disruptions of *Lucifer* production.

Notable Pilots

Pilot Elden Berardinelli: Considered the Combine's best pilot prior to the Fourth Succession War, Elden was integrated with a 'Mech company known as Sorensen's Sabres in the Fifth Sword of Light. This unusual organizational arrangement allowed Elden to support the Sabres from the air, more than making up for having one less 'Mech. Even when he wasn't able to do much damage to the ground forces, his presence distracted the enemy and made the Sabres' job a lot easier. Over Nusakan, a lucky shot through a heat sink air intake by a Kell Hound fighter nearly blew him out of the sky, but he managed to land the craft with minimal additional damage. Acquiring new *Samurai* parts was nearly impossible, and Elden attempted to adapt some *Corsair* parts to his *Samurai*. On a test run in 3032 the main engine failed catastrophically and Elden barely managed to bail out, suffering severe burns from a hydrogen fire. The Combine has been trying to bring him back out of retirement, but so far to no avail.

SL-25 SAMURAI

Type: **Samurai**

Technology Base: Inner Sphere

Tonnage: 50

Battle Value: 974

Equipment

Engine: 250

Safe Thrust: 7

Maximum Thrust: 11

Structural Integrity: 7

Heat Sinks: 19

Fuel: 640

Cockpit: 3

Armor Factor: 152

Armor Value

Nose 53

Wings 33/33

Aft 33

Weapons and Ammo	Location	Tonnage	Heat	SRV	MRV	LRV	ERV
3 Medium Laser	Nose	3	3	5	—	—	—
Small Laser	Nose	.5	1	3	—	—	—
Medium Laser	RW	1	3	5	—	—	—
Small Laser	RW	.5	1	3	—	—	—
Medium Laser	LW	1	3	5	—	—	—
Small Laser	LW	.5	1	3	—	—	—
Medium Laser	Aft	1	3	5	—	—	—
Small Laser	Aft	.5	1	3	—	—	—

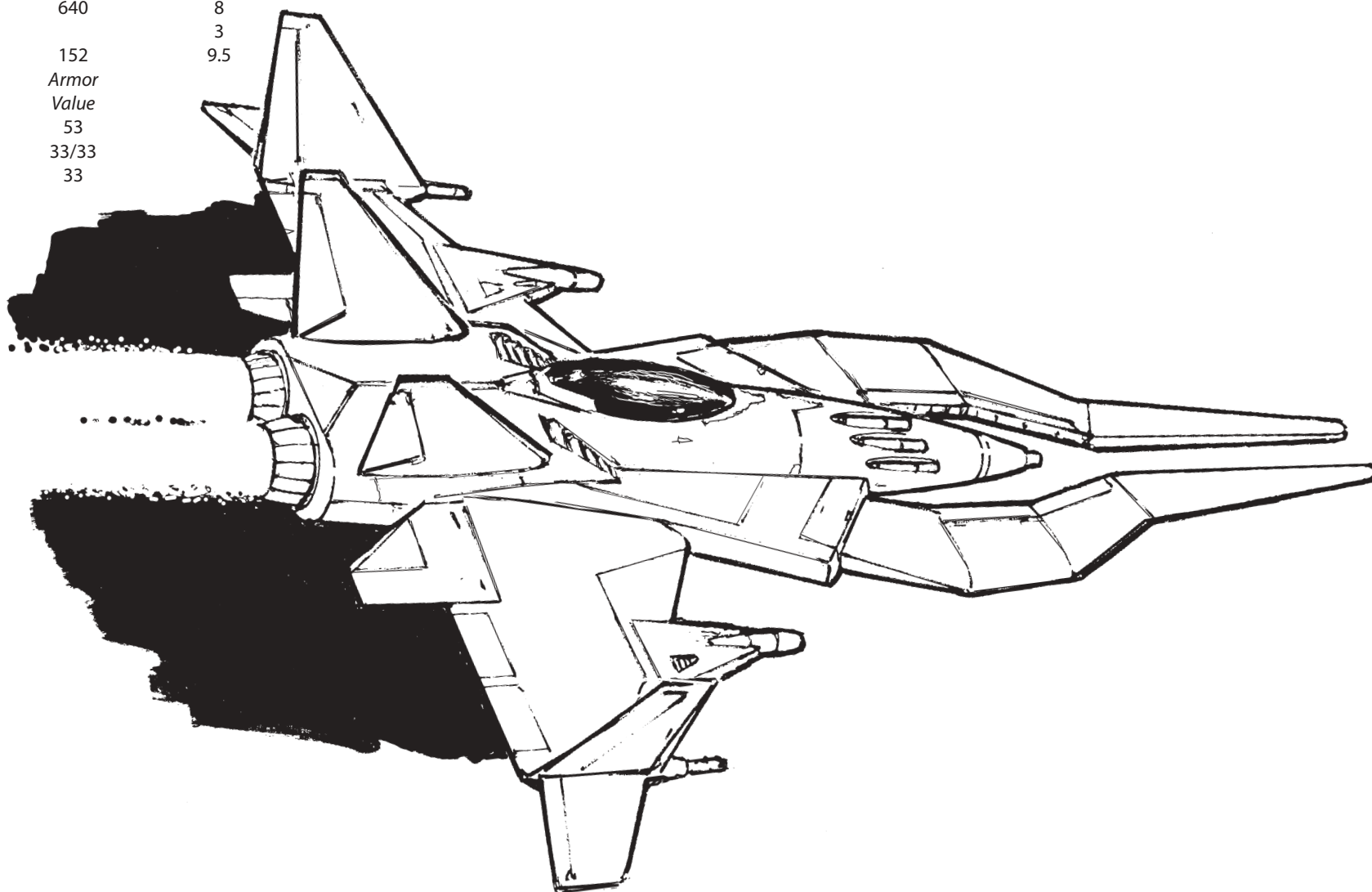

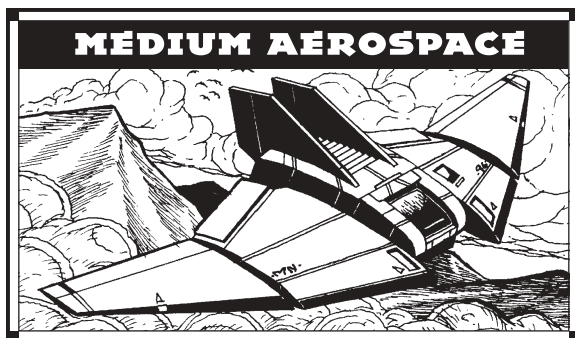

Mass: 50 tons

Chassis: Mujika Aerospace Type 18

Power Plant: Rawlings 200

Armor: Mujika AeroFiber

Armament:

1 Tomodzuru Type 20 Autocannon

4 Kajuka Type 2 "Bright Blossom" Medium Lasers

Manufacturer: Mujika Aerospace Technologies

Primary Factory: Capella

Communications System: Endicott Type 22 Maser

Targeting and Tracking System: Dwyerson Mark XII

Overview

The TR-10 *Transit* is widely used as the command aircraft for DropShips in many Liao air lances. It is also part of almost every garrison in the Capellan Confederation. With adequate armor and an extensive weapons array, this medium fighter serves extensively as a close-support BattleMech buster in major engagements. When the *Transit* appears above the battlefield, its distinctive silhouette creates apprehension among enemy MechWarriors.

Capabilities

While not much faster than House Liao's heavy fighter, the *Transgressor*, the *Transit* is a very potent medium-weight aerospace fighter because of its armor placement and durability. Four Kajuka medium lasers and a Tomodzuru autocannon provide the *Transit's* punch; the nose-mounted autocannon is especially effective against DropShips and can be devastating against BattleMechs, but the potential heat buildup can cause problems.

Though its armor is not the strongest among medium fighters, the *Transit* has proven sufficiently well-armored during most extra-atmospheric dogfights. Its staying power against comparable fighters has always been exemplary. When jumped by heavy fighters, however, it runs into trouble.

One major complaint pilots have is the large target the *Transit* presents compared to other medium fighters—many pilots feel that the designers could have created a more compact design. Conversely, the designers argue that the *Transit's* large wings and control surfaces make it one of the more airworthy aerospace fighters in the Successor States. The fighter is remarkably easy to fly, and uncontrolled maneuvers are rare. To many pilots, however, control is less important than speed and agility.

Deployment

Transits are a common sight among CCAF space defense and ground forces. Its rugged durability and low maintenance cycle appeal to many budget-conscious Capellan officers, especially during rebuilding efforts from the Fourth Succession War. The long string of successes during the Third Succession War certainly helped endear the fighter to the Strategios as well.

During a diversionary raid on New Aragon in 3012, Anson's Air Lance of the Fifth Regiment of McCarron's Armored Cavalry was ordered to maintain the rearguard as the rest of the unit lifted off-planet. Anson's pilots peppered the Davion 'Mechs with autocannon and laser fire and managed to keep the Davions' heads down until they ran out of ammunition.

As the enemy pressed forward toward the MAC's landing zone, Anson ordered his men to press the attack using just their lasers. The 'Mechs did not expect such a determined attack from the rear and several went down. Captain Anson kept pressing his advantage, and his fighters dropped two more 'Mechs before being recalled. Just as he was acknowledging it, a salvo of missiles from a Davion *Archer* obliterated his fighter in mid-air. His *Transit* was the only one lost in the engagement. Though most others suffered severe damage, they were recovered as the last DropShip boosted from the planet.

In 3015 the Dragoons and other forces loyal to Anton Marik jumped into Calloway VI and were hammered from

the start by FWLM forces. Wave after wave of aerofighters sniped at the inbound DropShips, savaging them and scattering the rebel forces across the planet. Two squadrons of Second and Sixth Oriente Hussars made up of *Transit* fighters jumped three DropShips of the Third Ducal Guard and managed to destroy an *Overlord* in one concentrated pass. Within five minutes, the remaining two DropShips were bleeding air as they entered the atmosphere; both missed their landing zones by hundreds of kilometers. The brutal space attacks diluted the rebel assault and kept the massive Earthwerks facility from capture.

Variants

Because of the *Transit's* tight design specifications, few variants are possible without requiring the entire fighter to be rebuilt. The TR-11 is a factory-built reconnaissance variant that removes the four lasers; instead, the cockpit is widened to make room for an observer and a large variety of scanning and sensor equipment. Some CCAF units use these as training aerofighters as well, though few of the pilot controls are linked to the observer's station.

Upgrades

Debuting in 3063, the TR-12 is a ground-up re-design of the *Transit*. A Rawlings 250 XL engine provides more power for less weight, allowing the lasers to be upgraded to ER models and the autocannon replaced with an LB 20-X with double the ammunition. The heat sinks are now double strength, while an extra ton of armor has been added.

Notable Pilots

Junior Pilot Miguel Jose Valdez: Hired in 3034 by Mujika Aerospace Technology, Valdez is considered one of the company's best test pilots. Valdez disappeared from the Capella plant in 3036. When he resurfaced on St. Ives the next year, it became apparent the young prodigy had defected.

TR-10 TRANSIT

Type: **Transit**
 Technology Base: Inner Sphere
 Tonnage: 50
 Battle Value: 1,127

Equipment		Mass
Engine:	200	8.5
Safe Thrust:	6	
Maximum Thrust:	9	
Structural Integrity:	6	
Heat Sinks:	13	3
Fuel:	400	5
Cockpit:		3
Armor Factor:	168	10.5
	<i>Armor Value</i>	
Nose	65	
Wings	35/35	
Aft	33	

Weapons and Ammo	Location	Tonnage	Heat	SRV	MRV	LRV	ERV
AC/20	Nose	14	7	20	—	—	—
Ammo (AC) 10	Nose	2					
2 Medium Lasers	Nose	2	3	5	—	—	—
Medium Laser	RW	1	3	5	—	—	—
Medium Laser	LW	1	3	5	—	—	—

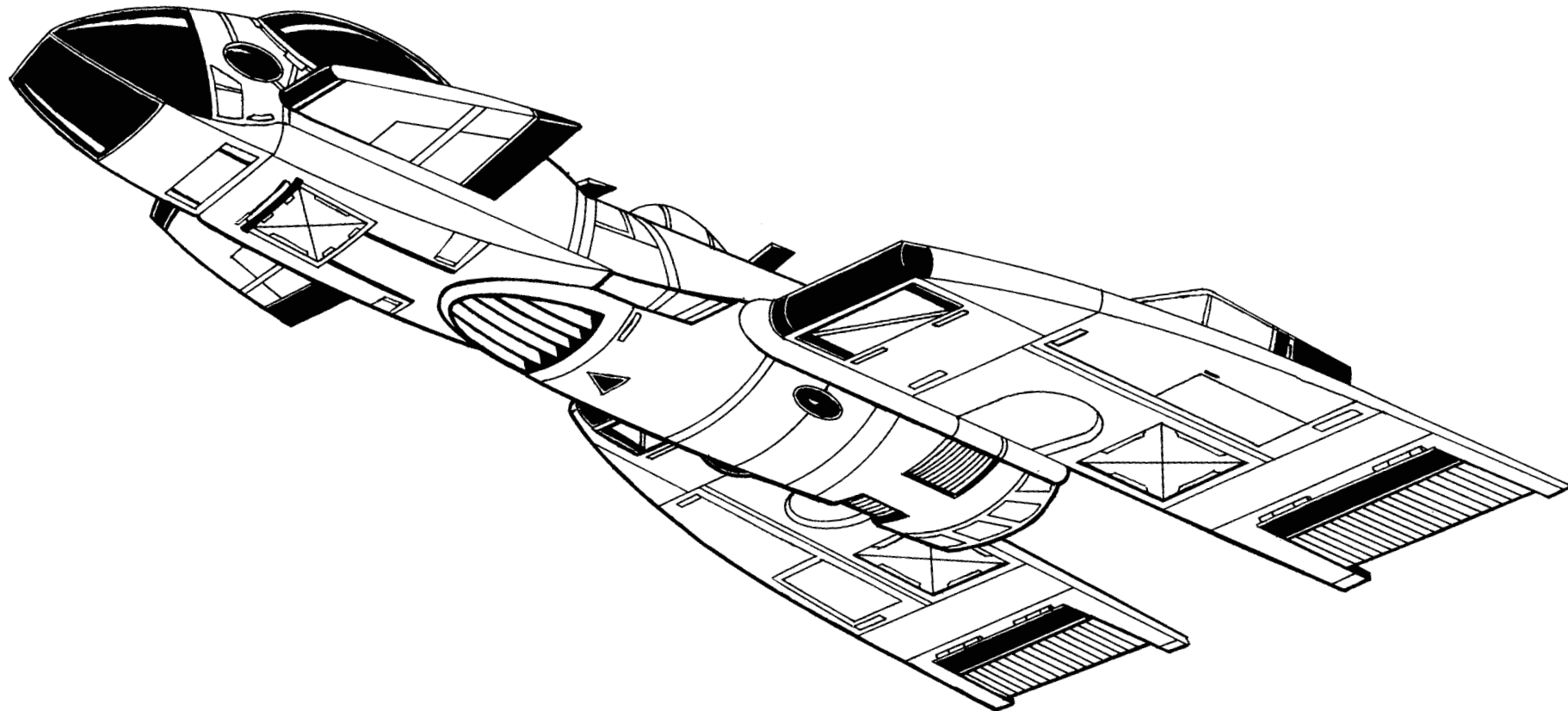

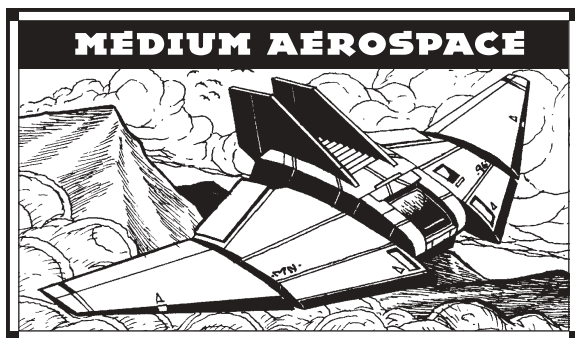

Mass: 60 tons

Chassis: F-90/A

Power Plant: VOX 240a

Armor: Andurien Steel Standard

Armament:

2 Hellion-b II Medium Lasers

2 Hellion-a III Large Lasers

1 Sunspot Particle Cannon

Manufacturer: Andurien Aerotech

Primary Factory: Andurien, Westover

Communications System: Telstar F-67

Targeting and Tracking System: SynCom VAX

Overview

The forward pitch of the F-90 *Stingray's* wings may seem counterintuitive, but the design concept employed by Andurien Aerotech's designers is over one thousand years old. Their angle of attack reduces wingtip vortices and provides a level of aerodynamic stability that would otherwise require much greater surface area. The forward canard wings give the fighter's heavy nose section additional lift in atmosphere, balancing the craft in atmospheric flight. Though not particularly swift, the design is exceptionally maneuverable in atmosphere. That maneuverability—in combination with a weapons array quite able to engage targets at range—makes the *Stingray* an opponent even heavy fighters treat with respect in air combat. Andurien Aerotech's decision to rely entirely on energy weapons means the *Stingray* can stay in combat far longer than fighters that depend on missiles or autocannons.

Capabilities

Developed in the waning days of the Star League, the *Stingray* is prized for its maneuverability, stability, and ability to take punishment in battle. It has been argued, however, that it is maneuverable only in the hands of a pilot who understands its unique characteristics. While the two pairs of lasers—both large and medium—are sensibly balanced in the wings, the massive Sunspot PPC is mounted far forward in the fighter's fuselage. To a pilot unused to the nose-heavy weight distribution, the plane feels unpredictable and unstable. New *Stingray* pilots often err on the side of caution, favoring conservative maneuvers and head-on attacks; beginning pilots often describe "dicey" or "slippery" flight characteristics. It takes months of experience for pilots used to more conventional fighters to develop the touch needed to take full advantage of the *Stingray's* abilities.

Deployment

Common throughout the Free Worlds League thanks to two factories within the League, the *Stingray* is the FWLM's standard medium fighter. Its popularity is such that the League government has pressured Andurien Aerotech to grant a license to the start-up firm Gutierrez Aerospace, founded by the ace *Stingray* pilot Maria Gutierrez, which started production in 3040 on Trellisane.

As of 3039, the other Houses typically had a squadron or two of *Stingrays*, primarily leftovers from the Star League (or, more rarely, from trade with the FWL). House Steiner is an exception, having inherited quite a few fighters from the Star League, enough for clashes between Steiner and Marik *Stingrays* to enter aerospace lore. Steiner was able to maintain its fleet of *Stingrays* despite lack of access to FWL factories.

Variants

House Steiner fields a ground-attack variant of the *Stingray*, the F90S, that replaces the Sunspot PPC and one heat sink with a class-5 autocannon and ammunition. The loss of punch and ammunition dependence limits this fighter's appeal and utility.

Upgrades

The popular *Stingray* was a target for upgrades as soon as states began recovering Star League technology. The F-92 traded the heavy weapons of the F-90 for their ER equivalents and replacing the heat sinks with double strength units. Gutierrez Aerospace's F-94 replaced the nose PPC with an extended-range large laser, exchanged the wing-mounted large lasers with ten-tube LRM racks, and added a nose-mounted medium laser. The F-95 was Gutierrez's next offering, after years of litigation gained it access to advanced equipment that Andurien had been restricting. Gutierrez started anew with the F-95, which mounted nineteen double heat sinks, exchanged the nose PPC with a heavy version, replaced all the wing lasers with two ER large lasers, and upgraded the armor to ferro-aluminum. The F-95 was due to enter FWLM service in 3069; the status of its production is currently unknown.

Notable Pilots

Major Julia Wuang: In early 3034 Chancellor Romano Liao ordered the elimination of the Shin Legions, which she regarded as dangerously disloyal. Suspecting their peril, the three legions planned an escape from Capellan space. Unfortunately, the omnipresent Maskirovka had discovered the plans. Though the Second Legion eliminated the spies and escaped unharmed, the Third was completely destroyed by ambush. The First Shin Legion was attacked by a regiment of Maskirovka-employed mercenaries supported by elements of the Holdfast Guard's feared Zong-shu Hang-ban ordered in by Chancellor Romano personally. After requesting that the Legion not waste time retrieving her squadron, Wuang led her *Stingrays* against a combined force of *Transits* and *Transgressors* that outnumbered them two to one. None of the First Shin fighters survived, but Colonel (now *Tai-sa*) Yanyouan credits the escape of the Legion's DropShips to Wuang's ferocious defense. The names of Major Wuang and her pilots are still carried on the First Shin's roll as a memorial.

F-90 STINGRAY

Type: **Stingray**

Technology Base: Inner Sphere

Tonnage: 60

Battle Value: 1,268

Equipment

Engine:	240
Safe Thrust:	6
Maximum Thrust:	9
Structural Integrity:	6
Heat Sinks:	20
Fuel:	400
Cockpit:	3
Armor Factor:	184
	<i>Armor Value</i>
Nose	60
Wings	45/45
Aft	34

Mass

11.5
10
5
3
11.5

Weapons and Ammo

	Location	Tonnage	Heat	SRV	MRV	LRV	ERV
PPC	Nose	7	10	10	10	—	—
Large Laser	RW	5	8	8	8	—	—
Large Laser	LW	5	8	8	8	—	—
Medium Laser	RW	1	3	5	—	—	—
Medium Laser	LW	1	3	5	—	—	—

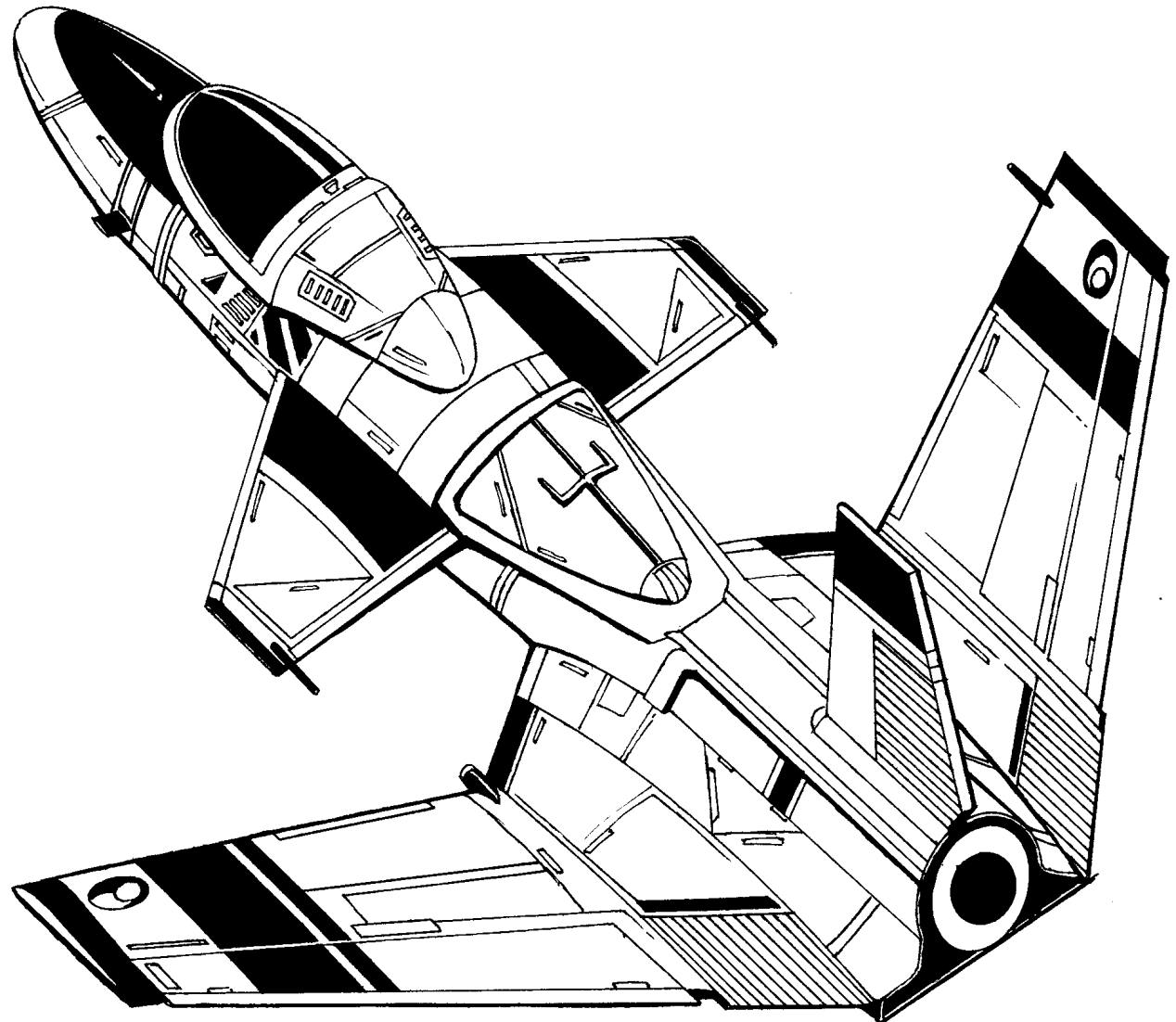

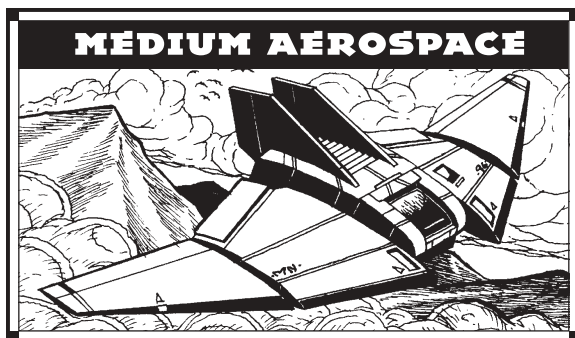

Mass: 65 tons

Chassis: Lockheed/CBM 200

Power Plant: WAS 195

Armor: StarScale Type IV

Armament:

- 1 Maxell Medium laser
- 1 Holly Long Range Missile 20-Rack
- 4 Maxell Small Lasers
- 2 Maxell Large Lasers

Manufacturer: Lockheed/CBM Corporation

Primary Factory: Donegal

Communications System: Lockheed/CBM COMSET 100

Targeting and Tracking System: Lockheed/CBM
TarSet 55

Overview

Nicknamed "The Dragger," the LCF series was plagued with difficulties from the start. Structural problems forced a full recall just two years after production started in 2526. A year later an issue with weapon cooling required widespread modifications. Despite a host of issues, the craft has been manufactured in large numbers and now is House Steiner's primary medium fighter.

Capabilities

A string of fatal accidents revealed structural problems that required significant modifications to the Lockheed/CBM 200 frame. While the revised *Lucifer* could now survive violent high-thrust maneuvers, the modifications necessitated the removal of the ejection system. Next, problems with the original Randolph lasers overloading the coolant system required a refit with the current Maxell weapons.

Other problems have not been corrected. Both the targeting and communications systems are sensitive to jarring and electromagnetic interference. Constant preventative maintenance is required, but even then the units are still often slightly off. The fighter's nose-heavy armor placement causes imbalance during dead-stick glide re-entry, a major problem now that the *Lucifer* lacks an emergency ejection system. There are issues with the large missile magazine, and internal explosions are common, even outside combat situations.

Were it not for the *Lucifer's* advantages, the design would have been consigned to the scrap heap centuries ago. Well armored and armed, the *Lucifer* has enough ammunition and heat sinks to maintain a withering barrage of fire—making it an excellent choice for DropShip interception.

Deployment

Despite its problems, the *Lucifer* significantly outnumbers fighters like the *Lightning* and *Hellcat* in Steiner's air arm.

The craft's limitations became evident at the battle for Loric in 2913. A defending force composed primarily of *Lucifers* was attacked by Marik Militia DropShips and fighters. Without support, the *Lucifers* soon got into trouble, and only the arrival of Steiner heavy fighters beat off the attackers.

In contrast, a raid by a Steiner wing on the Marik planet Rochelle was more successful. Spearheaded by three *Lucifers*, an attack on the DropShips of the Ninth Regular Hussars was a stunning success. With enough support from lighter fighters, the *Lucifers* penetrated the Hussars' fighter screen and braved a hail of defensive fire to inflict severe damage.

House Liao forces crossed into the Commonwealth in 2978 in hopes of catching the planet Summer off-guard. They were met in orbit by several *Lucifer* fighters, whose endurance held the Liao attackers at bay until heavier fighters could be launched.

Variants

The R20 replaces the Holly LRM rack with more armor and three more heat sinks. This version is useful in situations such as anti-DropShip combat, where prolonged fighting is likely to be necessary.

The LCF-R16K *Lucifer II* is a House Kurita version based on captured examples of the fighter. Over four tons of armor, four tons of LRM ammo, and one ton of fuel are removed to allow the installation of a more powerful Manatwist 260 engine and add a nose-mounted SRM 6 pack.

Upgrades

Advanced technology has been used in the new R16. Ferro-aluminum armor makes the *Lucifer* tougher than ever, and an Artemis IV fire-control system enhances the accuracy of its missiles. The large lasers are upgraded with ER technology and the aft laser is now a pulse model, but the small lasers have been replaced with two Streak SRM 2 launchers. Double heat sinks allow the R16 to deal with the extra heat. Unfortunately this new version still lacks an ejection system and retains the oversensitive communications systems.

Badly damaged in the Jihad, no *Lucifers* have been produced by Lockheed/CBM since the Word's assault on Donegal in 3068.

Kurita have also upgraded their LCF-16KR *Lucifer II* with an XL engine, ER large lasers, ferro-aluminum armor, and double heat sinks. The other lasers are upgraded to pulse models, but two small lasers are dropped for an additional nose-mounted SRM 6 launcher.

Notable Pilots

Captain Hamilton Atwyl: Atwyl serves in Wolf's Dragoons' Orbital/Aerospace Operations Group. His *Lucifer* bears thirty-seven victory markers, testimony to his unparalleled talent as a fighter pilot. He is particularly fond of combat with BattleMechs, and he often engages enemy targets on the ground; his one-on-one duel with a Davion *Rifleman* on Quentin has become the stuff of legends. Many expect Atwyl will one day command the Dragoons OOG.

Pilot Lewellen Stewart: An arrogant and cocky pilot, Stewart is currently assigned to Steiner's Royal Guards. He has a reputation for luck after being shot down in his *Lucifer* four times, always managing to come back. Though Stewart claims to have scored over one hundred kills, official records show the total to be closer to thirty.

LCF-R15 LUCIFER

Type: **Lucifer**

Technology Base: Inner Sphere

Tonnage: 65

Battle Value: 1,347

Equipment

Engine:	195	Mass	8
Safe Thrust:	5		
Maximum Thrust:	8		
Structural Integrity:	6		
Heat Sinks:	20	10	
Fuel:	400	5	
Cockpit:		3	
Armor Factor:	176	11	
	<i>Armor</i>		
	<i>Value</i>		
Nose	63		
Wings	38/38		
Aft	37		

Weapons and Ammo

	Location	Tonnage	Heat	SRV	MRV	LRV	ERV
2 Large Lasers	Nose	10	8	8	8	—	—
LRM 20	Nose	10	6	12	12	12	—
Ammo (LRM) 30	—	5					
2 Small Lasers	LW	1	1	3	—	—	—
2 Small Lasers	RW	1	1	3	—	—	—
Medium Laser	Aft	1	3	5	—	—	—

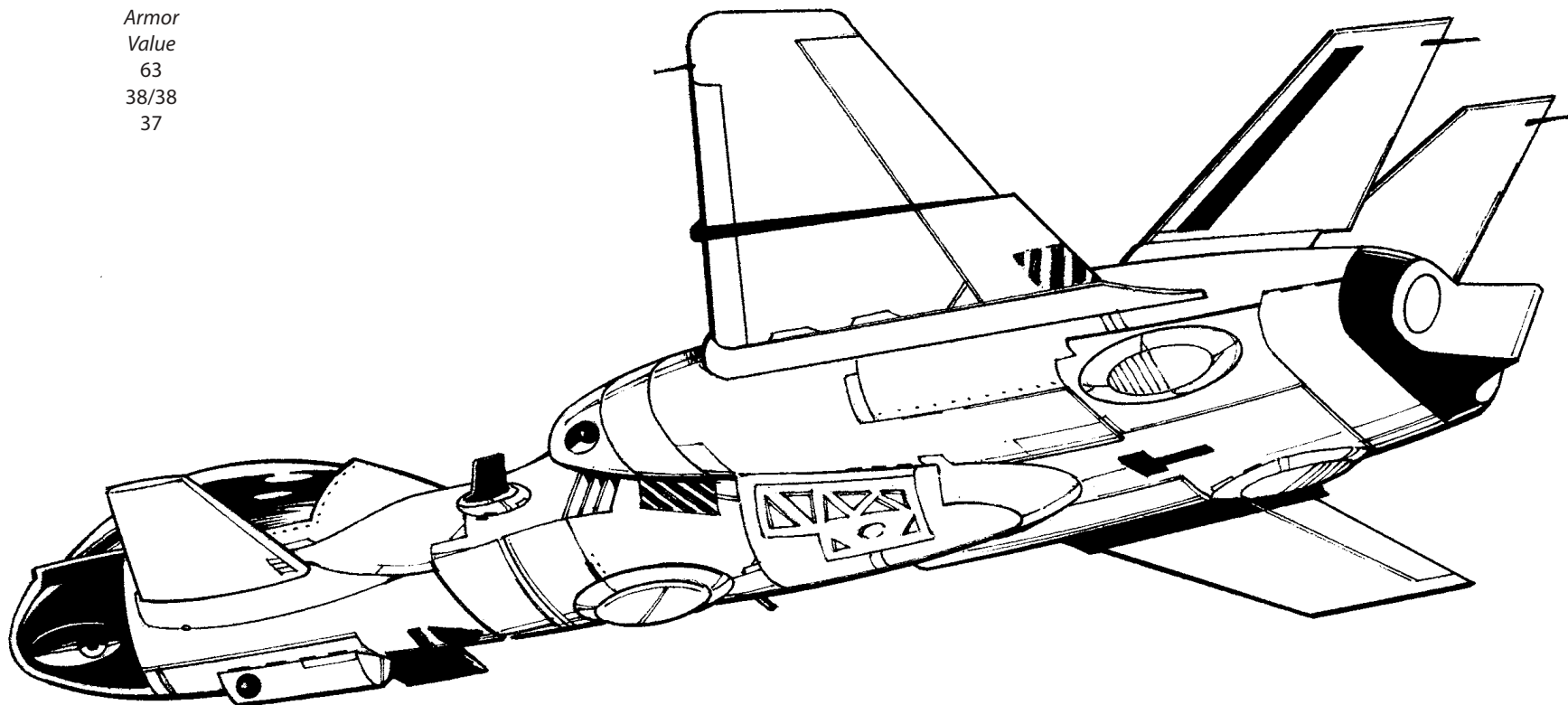

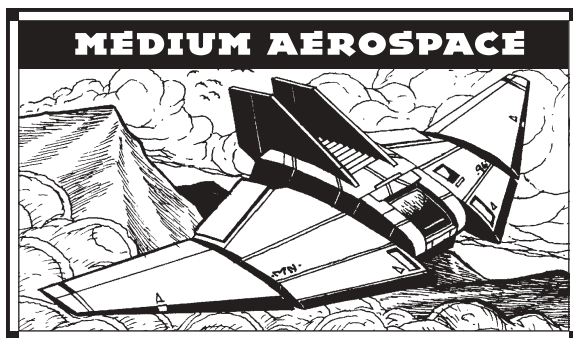

Mass: 65 tons

Chassis: Wakazashi III

Power Plant: Shinobi 260

Armor: Naketsu AeroWeave Standard

Armament:

1 Shigunga Long Range Missile 20-Rack

1 Diverse Optics Type 10 Large Laser

2 Diverse Optics Type 20 Medium Lasers

1 NCK "Thornbush" Short Range Missile Four-Rack

Manufacturer: Wakazashi Enterprises

Primary Factory: Chatham

Communications System: Duoteck 100

Targeting and Tracking System: RCA Instatrac Mark XI

Overview

The SL-17 *Shilone* is the primary medium fighter of the Draconis Combine Mustered Soldiery. Produced by Wakazashi Enterprises since the fall of the Star League, the *Shilone* is a large, well-armed and -armored fighter that has earned the respect of the Dragon's enemies through solid performance and reliable service. Called "The Boomerang" by its pilots, the *Shilone* is a fighter whose pilots are proud to fly it.

Although it is only produced within the Combine, the secession of the Free Rasalhague Republic left that nation with a large number of *Shilones*, which have been readily accepted by the Rasalhagian pilots.

Capabilities

Despite its capabilities and the fact that its mass approaches that of a heavy fighter, the *Shilone* is classified as a medium fighter craft. The nose-mounted Shigunga LRM rack and Diverse Optics Type 10 large laser give the fighter real punch at range, while at shorter ranges the wing-mounted Diverse Optics Type 20 medium lasers increase the striking power of the *Shilone's* forward-mounted weapons. To the rear, the *Shilone* can fire its NCK "Thornbush" short-range missile rack to keep opponents at a distance.

Common tactics for *Shilone* squadrons involve large wave assaults, which involve all the *Shilones* targeting their long-range missiles on one target as they close. Against other aerospace fighters this tactic is only somewhat effective, but against large targets like DropShips or orbital habitats, it is devastating. The *Shilones* then follow that up with precision fire from their Type 10 lasers, making a combined assault that few enemies can—or have—stood up to.

Deployment

The *Shilone's* first combat deployment was the infamous assault on Kentares IV during the First Succession War. It was the unexpected presence and firepower of the *Shilones* in the orbital assault force that allowed the Combine invaders to pierce the orbital screen and land troops. Since then, the *Shilone* has taken part in nearly every major aerospace action the Combine (and later the Free Rasalhague Republic) has ever fought.

Variants

Only one variant of the *Shilone* was ever produced, a striker version that replaces the Shigunga battery with a pair of autocannon/2s and a ton of ammunition. Although the damage potential of the *Shilone* is drastically reduced with this variant, the shock value of striking an enemy at extreme range is a powerful force multiplier.

Upgrades

One of the first uses of the rediscovered double-strength heat sinks was on the *Shilone*, which replaces all twenty with new freezers. This change was so minor that Wakazashi didn't bother to change the designator, though it is officially known as the 17R. With the Jihad raging,

Wakazashi has just released the SL-18 *Shilone*. The lasers are upgraded to extended-range models, while the armor is replaced with ferro-aluminum. The biggest change is the use of an extralight engine that frees up enough mass to replace the missile racks with Shigunga multi-missile launchers. Three nose- and one aft-mounted MML-7 racks, with four tons ammunition, make the new SL-18 deadly at any range.

Notable Pilots

Löjtnant Lars Angmarsson: Commander of a flight of *Shilones* responsible for local space around Elected Prince Magnusson's personal *Star Lord*-class JumpShip, the "Norseman," Angmarsson and his wingmen are experts in vacuum flight and spatial interdiction and interception. They routinely train with the massive Aerowing of the First Drakøns 'Mech regiment, a double-strength formation already famous for its skill and tenacity.

Chu-sa Hashiri Nitta: *Chu-sa* Nitta was the leader of a squadron of *Shilone* fighters tasked with stopping a DropShip of escaping *ronin* during the *Ronin* War of 3034. After escaping from a rebel base on Dieron, the *Union*-class DropShip and the pair of *Leopards* escorting it were burning at maximum acceleration for a waiting JumpShip. *Chu-sa* Nitta, a strong proponent and zealous adherent to Theodore Kurita's reforms to the Combine's military, ordered his squadron, based on a local *Olympus*-class station, to full acceleration and began pursuit. Thanks to fortunate timing, their interception geometry enabled the "short-legged" *Shilones* to catch the DropShips just as they were docking with the JumpShip.

Unfortunately for them, the *Shilones* had built up such a massive velocity from the long acceleration that they could not brake before reaching the JumpShip, and thus only had one pass before they overshot. Ordering his squadron to fire on the DropShips, *Chu-sa* Nitta adjusted his course and piloted his 65-ton fighter into the JumpShip's drive section, destroying it. Both of the DropShips already docked were destroyed, while a lucky hit from one of the *Shilones* disabled the remaining *Leopard's* drive. For his heroism, Nitta was posthumously awarded the Bushido Blade.

SL-17 SHILONE

Type: **Shilone**
 Technology Base: Inner Sphere
 Tonnage: 65
 Battle Value: 1,266

Equipment

		Mass
Engine:	260	13.5
Safe Thrust:	6	
Maximum Thrust:	9	
Structural Integrity:	6	
Heat Sinks:	20	10
Fuel:	400	5
Cockpit:		3
Armor Factor:	184	11.5
	<i>Armor Value</i>	
Nose	60	
Wings	44/44	
Aft	36	

Weapons and Ammo

	Location	Tonnage	Heat	SRV	MRV	LRV	ERV
LRM 20	Nose	10	6	12	12	12	—
Ammo (LRM) 12	—	2					
Large Laser	Nose	8	8	8	8	—	—
Medium Laser	RW	1	3	5	—	—	—
Medium Laser	LW	1	3	5	—	—	—
SRM 4	Rear	2	3	6	—	—	—
Ammo (SRM) 25	—	1					

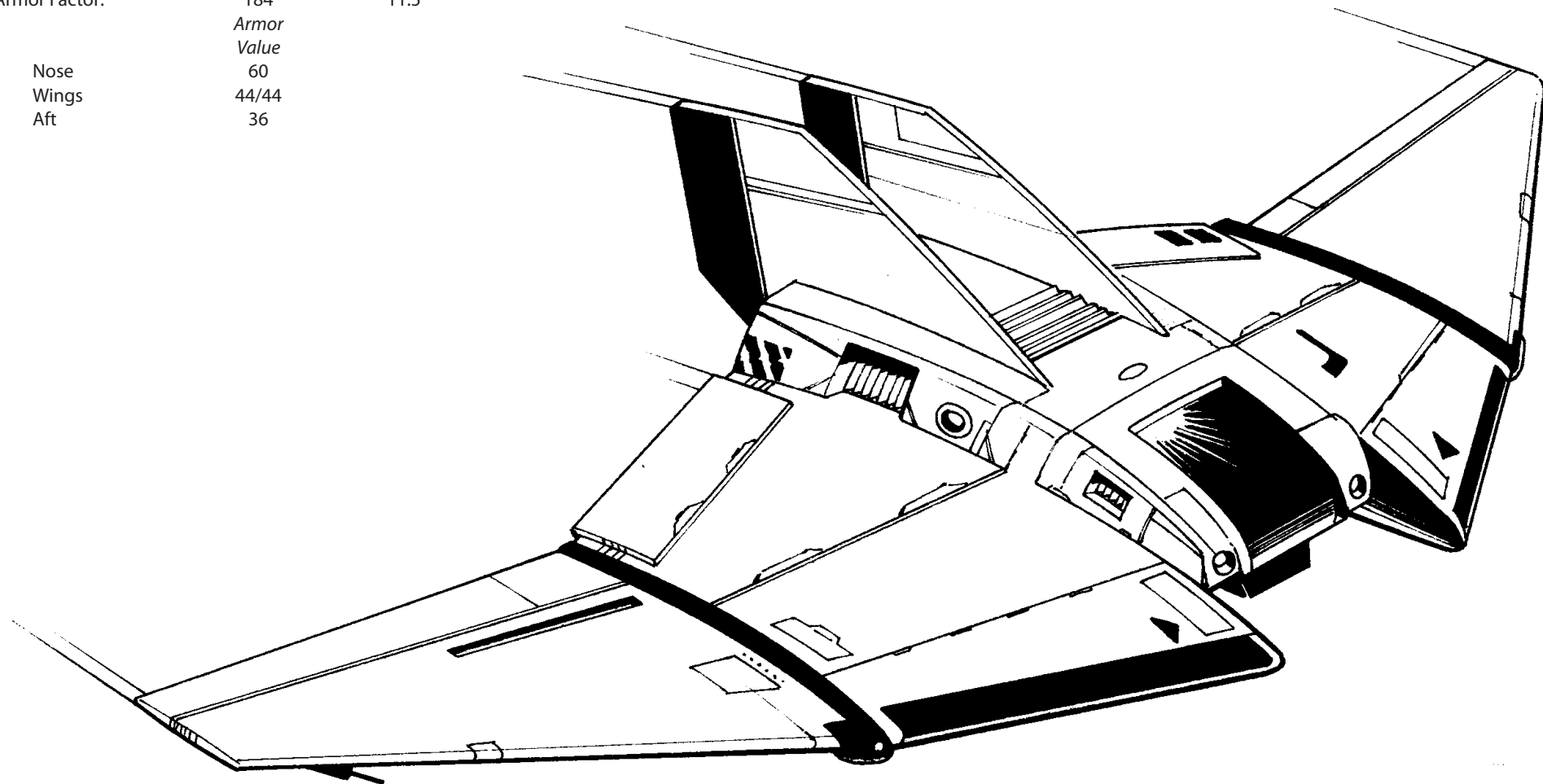

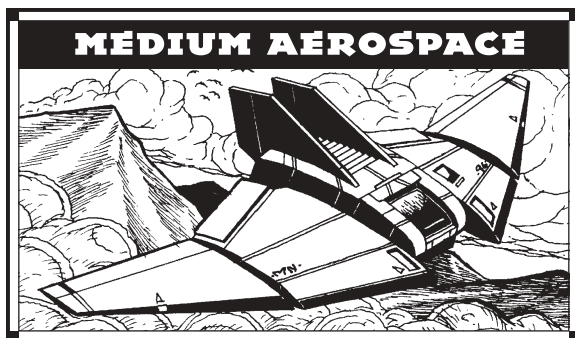

Mass: 75 tons

Chassis: Saroyan 13

Power Plant: Rawlings 300

Armor: Saroyan Standard

Armament:

3 Selitex Radionic Large Lasers

4 Kajuka Type 2 "Bright Blossom" Medium Lasers

Manufacturer: Saroyan Special Productions

Primary Factory: Sian

Communications System: Duoteck 95

Targeting and Tracking System: Radcom T11

Overview

The main heavy fighter in use by House Liao, the *Transgressor* is a common sight in DropShip hunter-killer squads and can be found in large numbers in important systems. Considered one of the most balanced designs in its time within the Successor States, this fighter is the reward the Confederation offers to favored commanders, no matter what weight class their squadron may be.

Capabilities

The *Transgressor* is an impressive heavy dogfighter and ground-support craft. While some fighters rely on missile racks or autocannons as the bulk of their firepower, the 75-ton *Transgressor* uses a trio of large lasers spread out among the wings and nose. A smaller medium laser backs up each one, and a fourth medium laser mounted in the aft protects the craft from any light fighters coming in from behind. Twenty-five heat sinks have allowed

the heavy fighter to continuously fire its heaviest weapons and remain cool, which lets pilots strafe enemy formations without heat concerns.

Deployment

With only the two *Transit* models and single *Transgressor* model still being produced inside the Capellan Confederation after the Fourth Succession War, CCAF aerospace forces quickly became top heavy. Though this made the force tougher on the average, the surviving aerospace forces have found themselves out-flown by Davion light fighters whenever encountered, further eroding their already low morale.

During Barton's raid on Addicks in November of 3039, McCarron's Armored Cavalry sustained heavy casualties while destroying many spaceport and civilian buildings, and they were forced into a fighting withdrawal off the planet. The Second Davion Guards and the March militia defenders, enraged over the civilian damage, pursued heavily and engaged the rear-guard aerospace fighters in a vicious dogfight. Of the Armored Cavalry fighters, a squadron of *Transgressors* was charged with protecting the transports at all costs. Spreading out for mutual cover, the swifter Davion fighters were not able to get into the aft of their targets without coming under heavy fire. The squadron was the only Armored Cavalry fighters not to retreat after the destruction of a friendly *Union*, and they destroyed twice their number before they fell.

Variants

The only variant available for decades, the TR-14 replaced the large lasers and a ton of armor with an AC/20 and two tons of ammo. This eliminated any worries of overheating and made the *Transgressor* a heavier version of the *Transit*; pilots complained about the shorter range and limited ammunition, as a protracted fight will leave the TR-14 with the firepower of a fighter one-third its size.

Upgrades

The first upgraded *Transgressors* appeared shortly after the announcement of the engagement of Sun-Tzu Liao and Isis Marik. These were mere field refits designated TR-13A, replacing the heat sinks with doubles and the large lasers with extended-ranged models. A TR-16 field refit kit also surfaced in 3058 for the maligned TR-14 variant. Mounting only ten double heat sinks and eleven tons of ferro-aluminum armor, its main weapons are twin nose-mounted Gauss rifles with three tons of ammo instead. Pilots of the T-14 variants have been enthusiastic about this refit kit and have been acquiring them as quickly as possible, though the armor replacement has been found to take twice as long as originally planned.

The latest model, the TR-15 fielded in 3071, mounts double heat sinks, extended-range medium lasers, and a single extended-range large laser. An extra-light engine allows the wing mounted large lasers to be swapped for heavy PPCs, while thirteen-and-a-half tons of ferro-aluminum armor protect the hull. These models, however, have the distinction of being the first upgraded *Transgressors* that have been built from a factory as opposed to units made with field refit kits. The first six off the production line were gifted to the aero-regiment Hell's Black Aces in gratitude for their bravery over Liao.

Notable Pilots

Lieutenant Benjamin Hsu: Then-Subcommander Hsu fled the Capellan Confederation along with his *Transgressor* in 3035, fearing he would be rounded up in one of Romano Liao's numerous purges despite being a vocal proponent of retaking the St Ives Compact and loyal to the hilt. On his flight to an awaiting DropShip, sent by the expatriate Hell's Black Aces mercenary unit to retrieve him, he was caught and attacked by a lance of *Transits* on patrol. His superior range and skills allowed him to dispatch the two fighters, but not before becoming heavily damaged and forced to do an unpowered retrieval in deep space with a DropShip's crane, something normally reserved for ground loading.

TR-13 TRANSGRESSOR

Type: **Transgressor**

Technology Base: Inner Sphere

Tonnage: 75

Battle Value: 1,449

Equipment

Engine:	300	Mass	19
Safe Thrust:	6		
Maximum Thrust:	9		
Structural Integrity:	7		
Heat Sinks:	25	15	
Fuel:	400	5	
Cockpit:		3	
Armor Factor:	224	14	
		<i>Armor Value</i>	
Nose	82		
Wings	51/51		
Aft	40		

Weapons and Ammo

	Location	Tonnage	Heat	SRV	MRV	LRV	ERV
Large Laser	Nose	5	8	8	8	—	—
Medium Laser	Nose	1	3	5	—	—	—
Large Laser	RW	5	8	8	8	—	—
Medium Laser	RW	1	3	5	—	—	—
Large Laser	LW	5	8	8	8	—	—
Medium Laser	LW	1	3	5	—	—	—
Medium Laser	Aft	1	3	5	—	—	—

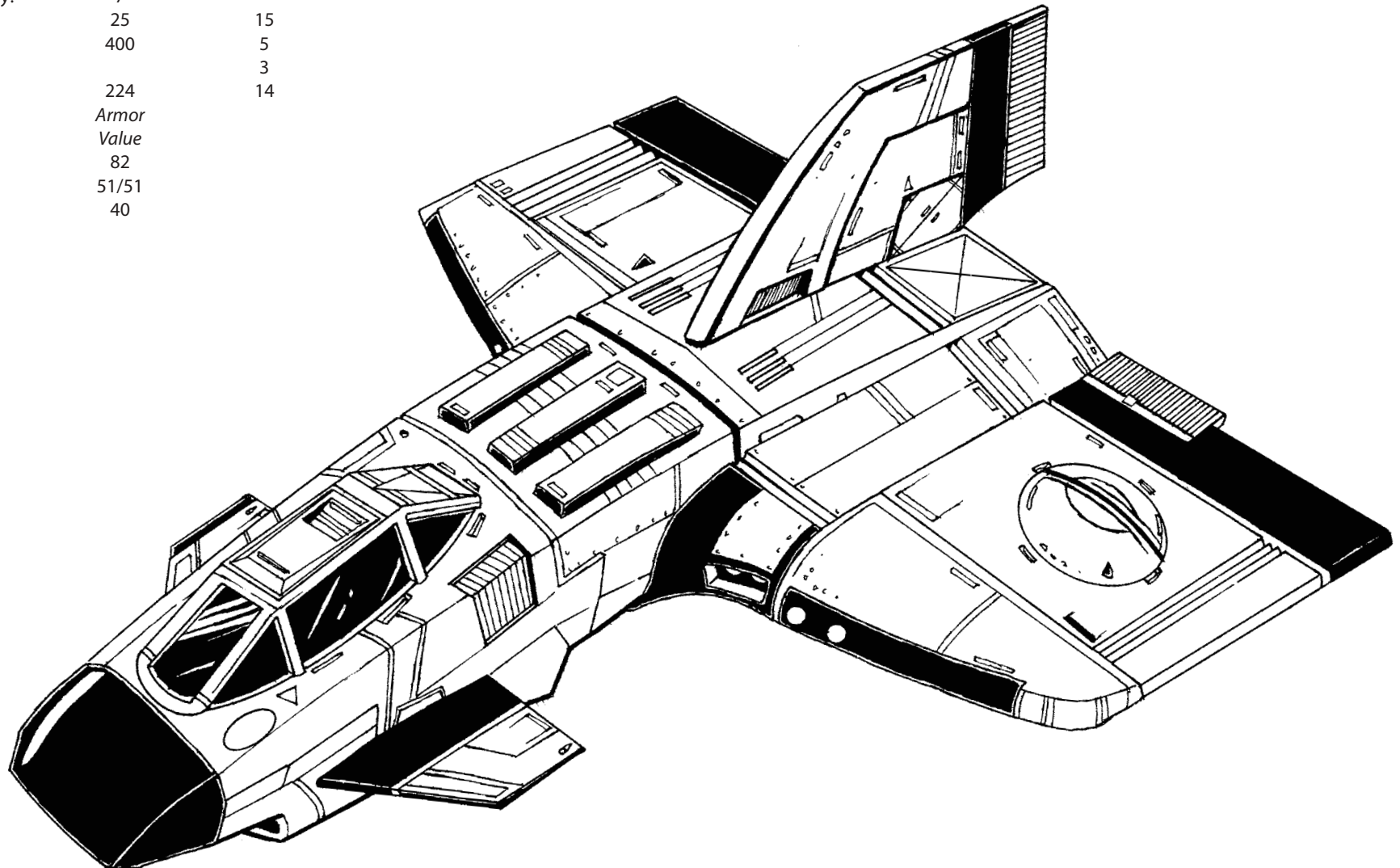

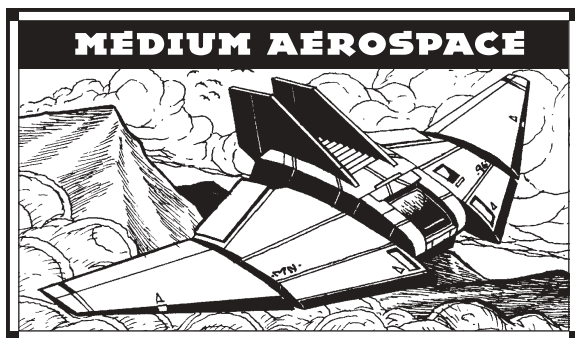

Mass: 80 tons

Chassis: Wakazashi V

Power Plant: Shinobi 320 Fusion

Armor: Naketsu AeroWeave Standard

Armament:

1 Zeus 56 Mark IV Autocannon, Type 10

6 Diverse Optics Type 20 Medium Laser

Manufacturer: Wakazashi Enterprises

Primary Factory: Dover

Communications System: Sony MSF-21

Targeting and Tracking System: Radcom T11

Overview

An iconic fighter for House Kurita since before the demise of the old Star League, the SL-15 *Slayer* and its prolific successor, the SL-15R, have been durable, multi-role heavy fighters, ably strafing and bombing groundpounders and hunting DropShip troop transports through the depths of space with equal aplomb.

Capabilities

With the Amaris Crisis raging, the *Slayer's* designers had little time to craft a fighter's typically complicated airframe. Their simple design was a blunt-nosed, voluminous, blended lifting body that performed adequately in most environments, from subsonic to hypersonic atmospheric flight and the alien environs of space. The Shinobi 320 addressed aerodynamic shortcomings with brute force and oversized maneuvering jets, enabling even the brick-like *Slayer* to fly.

The *Slayer's* suite of six lasers (five forward-firing), Class-10 autocannon, and twenty heat sinks enabled the SL-15 to sustain firing unless the engine's throttle was shoved to the firewall. With heavy armor and ten tons of fuel, the *Slayer* was equally adept at hunting faster fighters and DropShips, with its continuous firepower able to bring low almost any foe.

Deployment

The generally sound SL-15 *Slayer* served without noteworthy modification throughout the Succession Wars. Its versatile weaponry has allowed the *Slayer* to fill many roles, and the fighter has turned up in virtually every aerospace fighter unit in the Combine for almost three centuries. Its basic airframe remains in use in the minimally altered SL-15R and SL-15K upgrades.

Wakazashi licensed the SL-15 to the neutral Outworlds Alliance (United Outworlders Corporation on Ramora) and Taurian Concordat (Wingman Enterprises, Ltd. of Pinard), where it remains in production. The Magistracy (Alliance Aerospace Group) licensing attempt is in limbo owing to current confusion in the Combine's government.

Variants

Observing that missiles delivered more firepower per ton, Wakazashi offered a number of unpopular *Slayer* modification kits during the Third Succession War. These variants traded the autocannon for an LRM 15 and an SRM rack with two tons of ammunition each. The SL-15A mounts both racks in the nose, the SL-15B mounts the SRM aft, whilst the SL-15C has the LRM aft-mounted.

Upgrades

The solid performance of the SL-15 made the Combine reluctant to mess with success. The first upgrade of the SL-15 (and the only upgrade during a generation of fast-paced innovation) was the SL-15R, introduced in 3044, which swapped the Zeus 56 for an Emperor Code Red LB 10-X and an extra ton of ammunition. This minimal alteration was applied to new Combine production and made widely available in a simple field refit kit.

Only when supplies of extended-range lasers and double strength heat sinks seemed secure in 3066 did the Combine apply additional recovered technology to the *Slayer*. Wakazashi's SL-15K simply replaced the SL-15R's lasers with ER versions and updated the heat sinks. The SL-15K is also a depot-level refit kit for SL-15s and -15Rs. The DCMS hopes to standardize all SL-15s and SL-15Rs to the SL-15K beginning in 3069. [EDITOR'S NOTE: The recent troubles in the Combine have disrupted that program.]

Notable Pilots

Chu-i Robert McClure: *Chu-i* McClure of the Sixth Benjamin Regulars was ensconced in DCMS lore when Marduk's skies filled with AFFS DropShips in 3039. McClure led one of three squadrons sent to disrupt the landings. He and his wingman, Minerva McClure, were among the few pilots to reach the DropShips. Facing the giants with insufficient firepower, the husband and wife died as Kuritan warriors, ramming and destroying two *Unions* in quick succession. The remaining Kurita fighters were only able to cripple one *Overlord*. DCMS propaganda has made Robert and Minerva a staple of (wildly inaccurate) Combine romances.

Sho-i Minerva McClure: Minerva's family had enough clout to get her into flight school, but her non-Asian heritage and gender relegated her to secretarial duty in the Sixth Benjamin Regulars for an up-and-coming *Sho-i*, Robert McClure. McClure was a capable officer, an unexceptional pilot, and a man with predilections toward certain fetishes. As his adjunct, Minerva learned of McClure's inclinations and offered him a deal: she would deflect questions about his chaste bachelorhood by marrying him if she was assigned to pilot a *Slayer*. Robert, ever sensitive to appearances, accepted and had little trouble using Minerva's exceptional piloting qualifications to make her his wingman and using her beauty to end certain embarrassing inquiries from fellow pilots. It was Minerva's skill that made the pair shine in combat and her courage that inspired the effective final run on the First Robinson *Unions*. Minerva would be irked to see tawdry romances have reversed her marriage's roles—she now cast as the dutiful wife and supportive wingman to the bold and talented husband.

SL-15 SLAYER

Type: **Slayer**

Technology Base: Inner Sphere

Tonnage: 80

Battle Value: 1,347

Equipment

Engine: 320

Safe Thrust: 6

Maximum Thrust: 9

Structural Integrity: 8

Heat Sinks: 20

Fuel: 800

Cockpit: 3

Armor Factor: 232

Armor

Value

Nose 84

Wings 50/50

Aft 48

Weapons and Ammo	Location	Tonnage	Heat	SRV	MRV	LRV	ERV
AC/10	Nose	12	3	10	10	—	—
Ammo (AC) 20	—	2	—	—	—	—	—
Medium Laser	Nose	1	3	5	—	—	—
2 Medium Lasers	RW	2	3	5	—	—	—
2 Medium Lasers	LW	2	3	5	—	—	—
Medium Laser	Aft	1	3	5	—	—	—

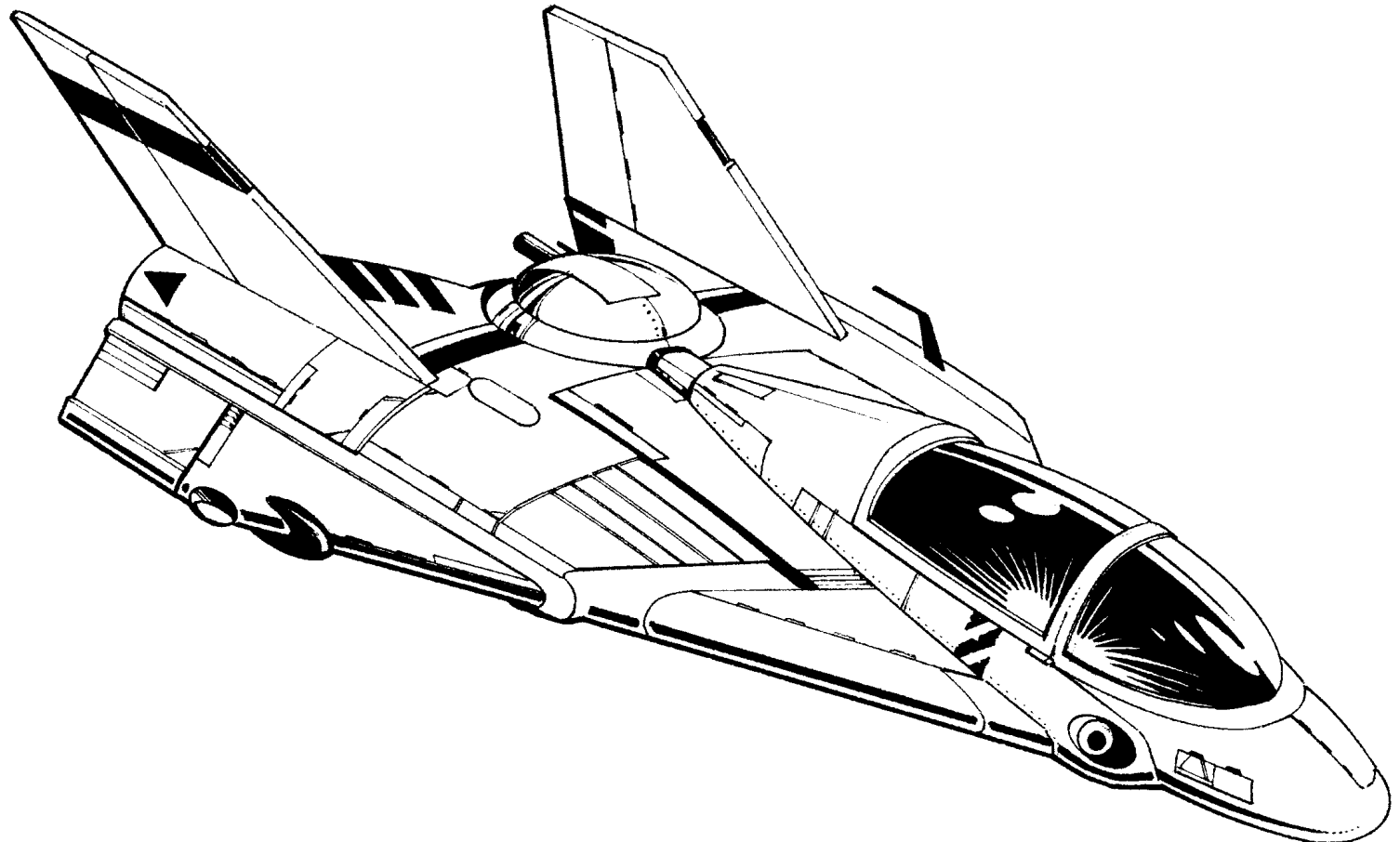

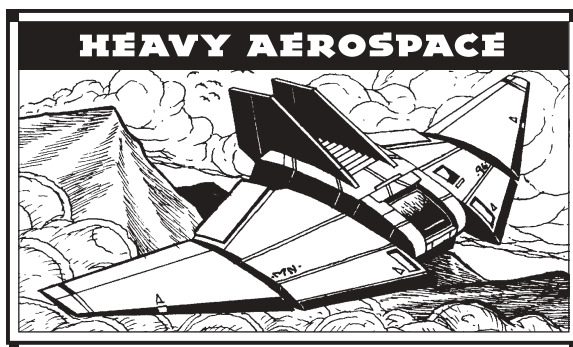

Mass: 90 tons

Chassis: Bowie 50

Power Plant: PlasmaStar 270

Armor: Wyatt Coresteel Standard

Armament:

2 Exostar Long-Range Missile 15 Racks

4 McCorkel Large Lasers

2 McCorkel Small Lasers

2 Martell Medium Lasers

1 Exostar Short-Range Missile 6-Rack

Manufacturer: Bowie Industries, Vandenberg
Mechanized Industries

Primary Factory: Dell (destroyed 2805),
Alarion (Bowie), New Vandenberg (VMI)

Communications System: Rander 200

Targeting and Tracking System: Rander TAS

Overview

The Star League was determined to bring the Periphery into their fold and had overwhelming forces to do so. To reduce losses, they asked for a quality offensive fighter from Bowie Industries. Bowie focused on short-ranged weapons with some supporting medium- and long-range coverage. When the League fell, most of the *Chippewas* and the Bowie factory found their way into the hands of House Steiner, and it has been the mainstay of their heavy fighter forces.

Capabilities

The *Chippewa* doesn't excel at speed or range—it is all about firepower. When approaching the enemy, thirty long-range missile tubes allow the *Chippewa* to get close behind cover fire. It can then bring its quad large lasers to bear, which can destroy medium fighters in a pair of salvos. If the opponent foolishly closes or allows the *Chippewa* to get into point blank range, they must face another pair of medium lasers and a six pack of short-ranged missiles. Dual small lasers deter the smaller fighters dogfighters that may get behind the *Chippewa*.

New *Chippewa* pilots complain about the lack of armor—specifically, how fighters half their size have as much protection—but veterans just shrug and say, “shoot more.” While this may be flippant, it also shows one of the strongest points of the *Chippewa*: heat sinks. With twenty-five heat sinks, it can fire a good selection of its weapons without worrying about the heat levels crippling their fighter. Bowie also had developed special insulation for the large lasers that contained the lasers' heat, giving the fighters' heat sinks extra time to cool the weapons. Against ground targets, the strafing ability of all six lasers is devastating.

Deployment

The majority of *Chippewas* are found in the Federated Commonwealth forces, especially Lyran units. Most other houses have some *Chippewas*, the Draconis Combine being an exception. After the destruction of the Dell compound, the Commonwealth was still able to make parts for the *Chippewa*, allowing them to maintain their stock while the others' were slowly depleted. Before the Third Succession War, Bowie rebuilt the *Chippewa* line on Alarion. Recently, the Taurian Concordat has been licensed to manufacture the *Chippewa*. Bowie officials figured that they were going to make the fighter anyway and they could use the money to start redesigning the *Chippewa*.

Variants

House Davion's few *Chippewas* have been modified to add more armor to the fighter at the cost of lasers. Capellan and Marik *Chippewas* are unmodified; they usually get escorts to take some enemy fire until the *Chippewa's* firepower can be brought to bear.

Upgrades

Prior to the Clan invasion, Bowie had changed to the version that the Star League had upgraded to, the W7. The large and small lasers were replaced with pulse models while the heat sinks were upgraded to double capacity. An extra-light engine and ferro-aluminum armor allow these modifications. Prior to the Blakist assault of Alarion, Bowie had upgraded the W7 to a W8. The W8 utilizes heavy ferro-aluminum armor and moves the medium lasers to the wings. This allows the missile launchers to be replaced with three MML-7s with Artemis IV FCS, while the rear lasers are upgraded to extended-range versions.

New Vandenberg has gone a different route. From a base W7, the W7T replaces the large pulse lasers with a pair of snub-nosed PPCs and a pair of plasma rifles. The weight savings allow the LRM launchers to be outfitted with Artemis IV targeting systems. They also continue to manufacture the W5 model.

Notable Pilots

Leutenant Libby Saunders: At 1.5 meters and 38 kg, few would suspect Leutenant Saunders is an excellent athlete and elite pilot. As a hobby, she runs super marathons which have allowed her to deal with G-forces that would cause larger pilots to pass out. She has killed over a dozen *Shilones* who thought their superior acceleration would be enough to beat the somewhat sluggish *Chippewa*. In addition to chest-crushing turns, she utilizes gravity wells to equalize her lack of acceleration while flying with the Sixth Lyran Guard.

Hauptmann Hank McCleary: A good pilot in his own right, Hank's father Dan was a legend. Trying to get out of his father's shadow while still honoring his dad was difficult, but his actions at the Battle of Alexandria helped him become the first recipient of the McCleary Award for Heroism. The *Slayers* he faced had speed and armor, but their firepower was not nearly enough to threaten him. When they closed to bring their lasers into play, his larger lasers and missiles were too much.

CHP-W5 CHIPPEWA

Type: **Chippewa**

Technology Base: Inner Sphere

Tonnage: 90

Battle Value: 1,556

Equipment

Engine:	270
Safe Thrust:	5
Maximum Thrust:	8
Structural Integrity:	9
Heat Sinks:	25
Fuel:	400
Cockpit:	3
Armor Factor:	120
	<i>Armor Value</i>
Nose	43
Wings	24/24
Aft	29

Mass
14.5

15
5
3
7.5

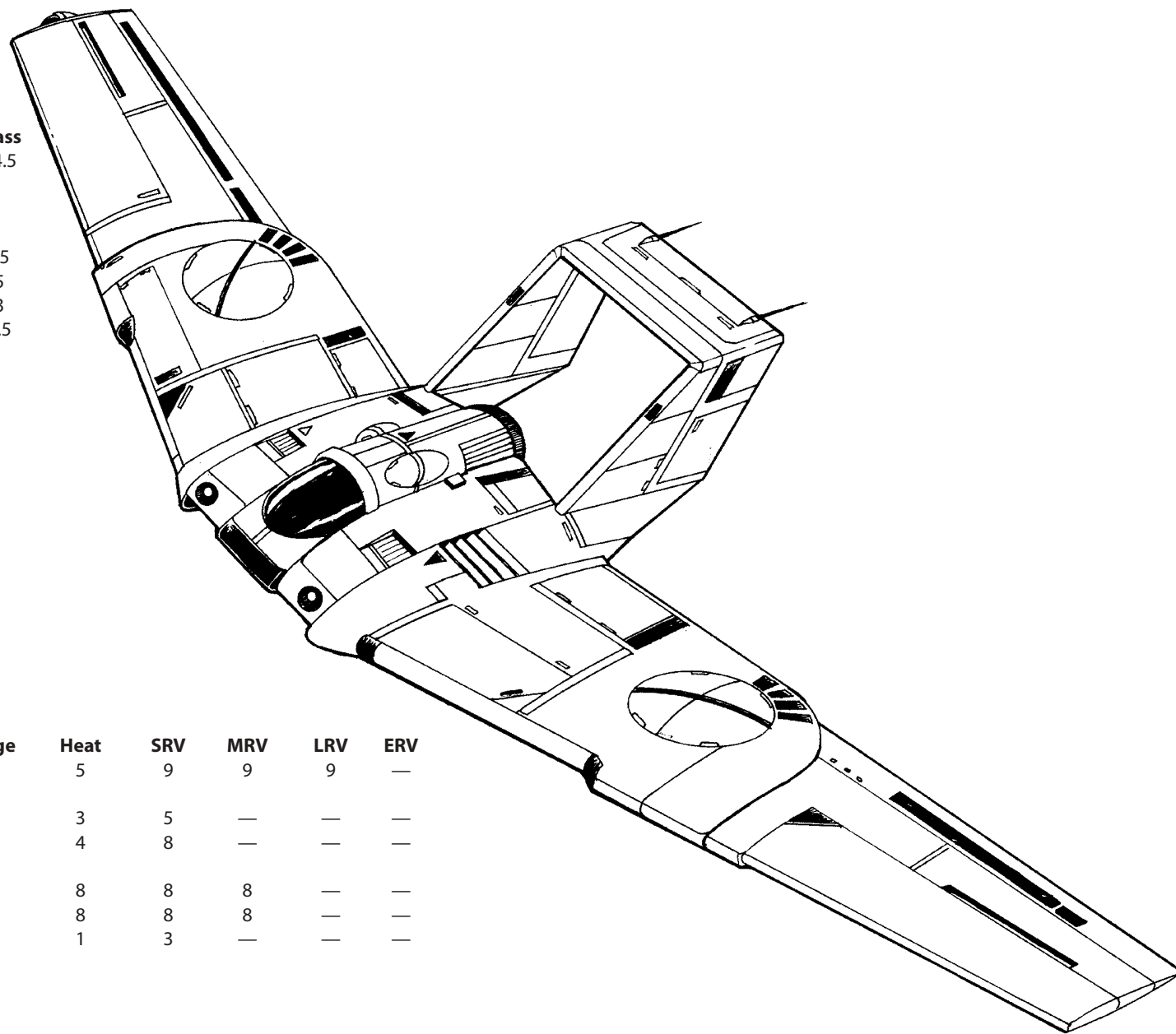

Weapons and Ammo	Location	Tonnage	Heat	SRV	MRV	LRV	ERV
2 LRM 15	Nose	14	5	9	9	9	—
Ammo (LRM) 32	Body	4					
2 Medium Lasers	Nose	2	3	5	—	—	—
SRM 6	Nose	3	4	8	—	—	—
Ammo (SRM) 15	Body	1					
2 Large Lasers	RW	10	8	8	8	—	—
2 Large Lasers	LW	10	8	8	8	—	—
2 Small Lasers	Aft	1	1	3	—	—	—



Mass: 100 tons

Chassis: Interstar Heavy

Power Plant: Pitban 300a

Armor: Riese 710

Armament:

1 Imperator Zeta-a Class 20 Autocannon

4 Beta-6 SRM Launchers

1 Gamma-10 LRM Launcher

Manufacturer: Andurien AeroTech (a Division of Free Worlds Defense Industries)

Primary Factory: Andurien

Communications System: Lassitor-3QZ

Targeting and Tracking System: IMB SYS 3740

Overview

Unlike many other fighters, the F-100 *Riever* is not a copy of a Star League-era fighter but an original design. With losses to the Free Worlds League AeroSpace arm mounting at an alarming rate, Captain-General Thaddeus Marik called for a heavy fighter that the League could produce in quantity using its ravaged industrial and technological base. The result lacks the sophistication of designs such *Chippewa*, but it is reliable and easy to repair.

Capabilities

The *Riever* was designed purely as an aerospace superiority fighter. The reliable Imperator Zeta Class-20 Autocannon provides the main armament. Ammunition supply is limited to ten rounds, but few targets are well enough armored to escape crippling damage from even one hit. Four supporting Beta-6 SRM launchers produce a salvo of missiles almost as deadly as the autocannon.

A single Gamma-10 LRM launcher provides limited long-range firepower. As a result, the heavily armored *Riever* must often endure stinging damage from small craft, but if a lighter enemy enters range of the *Riever's* main weapons, the battle usually ends right there.

The *Riever's* graceful design gives it the lift needed to function in atmosphere, but it also presented some interesting structural problems. Stresses on the *Riever's* soaring wings resulted in catastrophic crashes in early models. The original solution was heavy, supplementary spars to brace the wings, but this left the *Riever* substantially overweight. A more elegant solution was found by transferring the heavy autocannon to a more stable position in the fighter's center, which reduced both the bracing and the wing loading to tolerable levels.

One unanticipated peril facing *Riever* pilots is friendly fire from inexperienced Marik pilots or DropShip crews. Often they will mistake the soaring wing-shaped *Riever* for a Steiner *Chippewa*.

Deployment

Introduced in 2815, the *Riever* has become the mainstay of Marik aerospace forces. Ill-suited for ground attack missions, the *Riever* leaves such duties to the lighter *Stingray*.

The *Riever* first saw action in battle with House Steiner on Phecda III, where the strange fighter had great success against the confused defenders until chronic wing loading and stress problems crippled several *Rievers*.

Flaws fixed, the *Riever* was back in action against the rebellious garrison on Graham IV in 2820. Scrambled to meet rebel *Hellcats*, the *Rievers* became embroiled in a vicious dogfight. The experienced rebel pilots quickly gained positional advantage, slipping into the slots behind the cumbersome heavy fighters. Though accurate, the rebel laser fire made little impression on the well-armored *Rievers*. Reversing on their opponents, the *Rievers* opened up. Heavy autocannon shells and SRMs tore through *Hellcat* armor like paper, forcing many of the rebel fighters to jettison their bomb loads and run for home.

Variants

Designed for DropShip assaults, the F-100a replaces the Gamma-10 LRM launcher with two more Beta-6 SRM launchers.

The Kurita Combine Munitions Corporation has obtained a contract to produce the F-100b for the Draconis Combine. This variant sacrifices two tons of armor and is armed with two Class 5 autocannons in place of the SRM launchers.

Upgrades

The F-700 uses a Pitban 400XL engine to improve both acceleration and agility. The only other change to the basic design is the installation of double heat sinks and an expanded autocannon magazine.

A more ambitious upgrade, the F-700a uses a Pitban 300XL power plant. The autocannon and LRM launcher are replaced with a pair of LB 10-X autocannons and four tons of ammunition. No less than eight SRM 6 launchers dot the craft (three in each wing and two in the nose). Double heat sinks allow the F-700a to deal with the heat generated, and armor is increased to over sixteen tons.

The latest variant, the F-700b, version, also uses a Pitban 300XL power plant and double heat sinks. The autocannon is upgraded to an Ultra model with twice the magazine capacity, and the SRM launchers have been updated to Streak technology with an extra launcher in each wing. Armor protection is boosted to over sixteen tons of ferro-aluminum armor.

Notable Pilots

Force Commander Arthur Lohkamp: Formally an instructor at the Marik Military Academy, Force Commander Lohkamp secretly nursed political ambitions. Backing Duncan Marik's bid to become Captain-General, Arthur was forced to flee the Free Worlds League when Thomas Marik unexpectedly returned from the dead.

A tall, red-haired man with a bushy, rather unkempt mustache and a ready smile, Lohkamp is an expert in air-to-air combat with twenty kills to his credit. Unable to return home, Lohkamp is using his *Riever* to scratch out a living as a freelance mercenary.

F-100 RIEVER

Type: **Riever**

Technology Base: Inner Sphere

Tonnage: 100

Battle Value: 1,611

Equipment

		Mass
Engine:	300	19
Safe Thrust:	5	
Maximum Thrust:	8	
Structural Integrity:	10	
Heat Sinks:	28	18
Fuel:	400	5
Cockpit:		3
Armor Factor:	256	16
	<i>Armor Value</i>	
Nose	86	
Wings	61/61	
Aft	48	

Weapons and Ammo

	Location	Tonnage	Heat	SRV	MRV	LRV	ERV
AC/20	Nose	14	7	20	—	—	—
Ammo (AC) 10	—	2					
LRM 10	Nose	5	4	6	6	6	—
Ammo (LRM) 24	—	2					
2 SRM 6	RW	6	4	8	—	—	—
Ammo (SRM) 30	—	2					
2 SRM 6	LW	6	4	8	—	—	—
Ammo (SRM) 30	—	2					

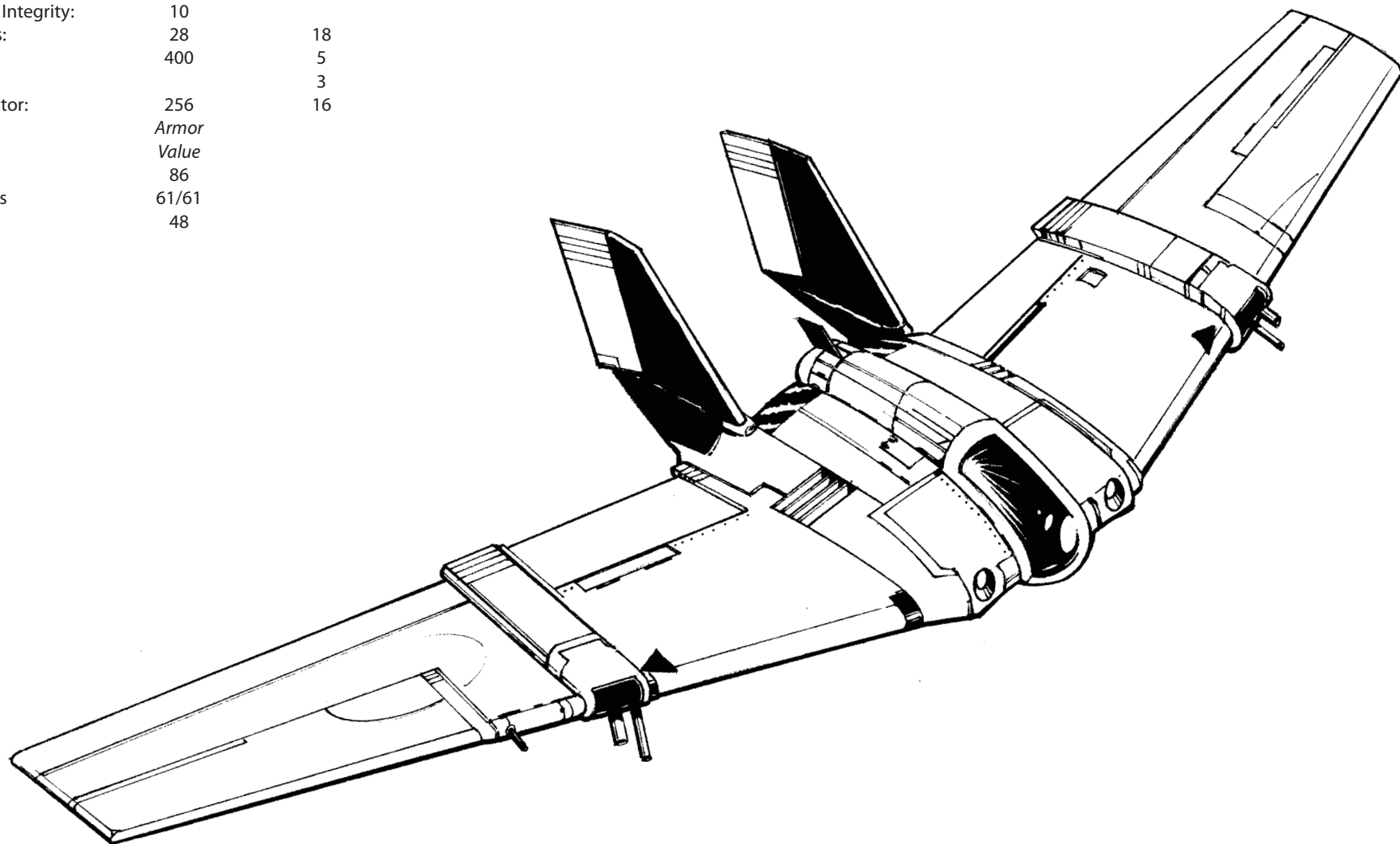



Mass: 100 tons

Chassis: Lycomb 11

Power Plant: GM 300ATF

Armor: AeroScale Plus

Armament:

4 Exostar Large Lasers

1 Simpson Long Range Missile 20 Rack

1 Holly Short Missile 4 Rack

3 Martell Medium Lasers

Manufacturer: Lycomb-Davion IntroTech

Primary Factory: New Avalon

Communications System: O/P 9000AT

Targeting and Tracking System: O/P 2500TGFD

Overview

Hailed as a sleek and powerful design, Lycomb IntraTechnologies' *Stuka* entered service with the Terran Hegemony in 2530. Forty years later, with war in the Periphery now inevitable, the newly formed Star League Defense Force also wanted the fighter. To meet this demand, Lycomb opened a second production line on Demeter.

Production continued into the First Succession War, at which point the Federated Suns took control of Lycomb's assets in a friendly acquisition and secretly duplicated several production lines on New Avalon. This proved a wise precaution, as the Demeter *Stuka* factory was bombed by House Liao soon after.

Capabilities

The early K1 and K2 prototypes revealed problems with heat dissipation and structural instability in the heavy wings, each of which support a heavy weapon pod. The

classic K5 came off the drawing boards just before the Reunification War, correcting these issues.

Many pilots consider the *Stuka* nothing short of a dream come true. Armed and armored to the point that it resembles a flying tank, the *Stuka's* Monitor 200 guidance system imbues the craft with a grace and maneuverability that belies its mass. Pilots consider the fighter a joy to fly, especially in atmosphere where many heavy fighters perform poorly. All these features make the *Stuka* an excellent ground attack fighter.

Deployment

House Davion has maintained a monopoly on *Stuka* production. Together with the *Sparrowhawk* and *Corsair*, the *Stuka* forms the bulk of the AFFS' fighter arm. The Avalon Hussars and Crucis Lancers employ the fighter extensively in the ground attack role to provide close air support.

In 2899 the Fifteenth Sword of Light's combat drop over Quentin was met by a fighter wing led by *Stukas*. The big fighters tore through the heavily laden Kurita DropShips as they struggled to maneuver in Quentin's upper atmosphere. Few Kurita ships escaped, and the Fifteenth Sword of Light was struck from the rolls.

The Seventeenth Avalon Hussars employed their *Stukas* to bomb and strafe the Liao defenders on Lee in 2930. This sudden rain of firepower led to several Davion advances, ending in the Federated Suns' capture of that world.

Believing the defenses of Kesai IV to be under strength, House Kurita launched an attack in 2999. In reality the information had been planted by Davion agents. Laying in wait, a wing of *Stukas* pounced on Kurita fighters returning from ground attack missions. Low on fuel and ammunition, the DCMS force was decimated.

Variants

The K10 is flown by the Draconis March Militia. It replaces the nose-mounted Martell medium laser and the SRM launcher with two more heat sinks and four Exostar small lasers. The K15 has proven to be unpopular with pilots and has seen only limited deployment. It replaces three tons of armor with six smaller lasers—three in each wing.

Upgrades

Upgrading the *Stuka* was a priority for the Federated Commonwealth. The STU-D6 drops ten heat sinks, but upgrades those that remain to double efficiency models. Additional mass is freed up with the installation of an XL engine. The nose-mounted missile launchers are replaced by two SRM 6 packs and four tons of ammunition, and an LRM 20 launcher and two tons of ammunition is added to each wing.

The new STU-D7 is a powerful upgrade to the STU-D6. A new rotary autocannon/5 and two tons of ammunition replaces each LRM launcher. The large lasers have been swapped out for three ER medium lasers in each wing, and the other lasers are also ER models. An LRM 20 with three tons of ammunition has been reinstated in the nose, and all missile launchers tie into sophisticated Artemis IV fire control. One heat sink has been added.

Notable Pilots

Captain Mark Allan: Mark has performed well with several units, including the Avalon Hussars, Syrtis Fusiliers, and the NAIS Cadre. He and his *Stuka* are currently attached to the prestigious Davion Guards brigade, where he is considered one of their most skilled and professional pilots.

Pilot James Doogan: A member of Wolf's Dragoons, Doogan is one of the very few non-Davion pilots to operate a *Stuka*. His all-black *Stuka*, "*Dark Death*," was given to the Dragoons after it was captured by Kurita forces.

Ironically, the *Dark Death* would destroy more Kurita fighters than Davion ones. Failing to coerce the Dragoons into remaining after their contract ended, the DCMS sent a force after the convoy of Dragoon dependents fleeing to safety in the Federated Suns. Leading a fanatical defense, Doogan's *Stuka* sliced through the attacking Galedon Regulars' fighters.

STU-K5 STUKA

Type: **Stuka**

Technology Base: Inner Sphere

Tonnage: 100

Battle Value: 1,794

Equipment

		Mass
Engine:	300	19
Safe Thrust:	5	
Maximum Thrust:	8	
Structural Integrity:	10	
Heat Sinks:	30	20
Fuel:	400	5
Cockpit:		3
Armor Factor:	240	15
	<i>Armor Value</i>	
Nose	84	
Wings	54/54	
Aft	48	

Weapons and Ammo

	Location	Tonnage	Heat	SRV	MRV	LRV	ERV
Medium Laser	Nose	1	3	5	—	—	—
LRM 20	Nose	10	6	12	12	12	—
Ammo (LRM) 12	—	2					
SRM 4	Nose	2	3	6	—	—	—
Ammo (SRM) 25	—	1					
2 Large Lasers	RW	10	8	8	8	—	—
2 Large Lasers	LW	10	8	8	8	—	—
2 Medium Lasers	Aft	2	3	5	—	—	—

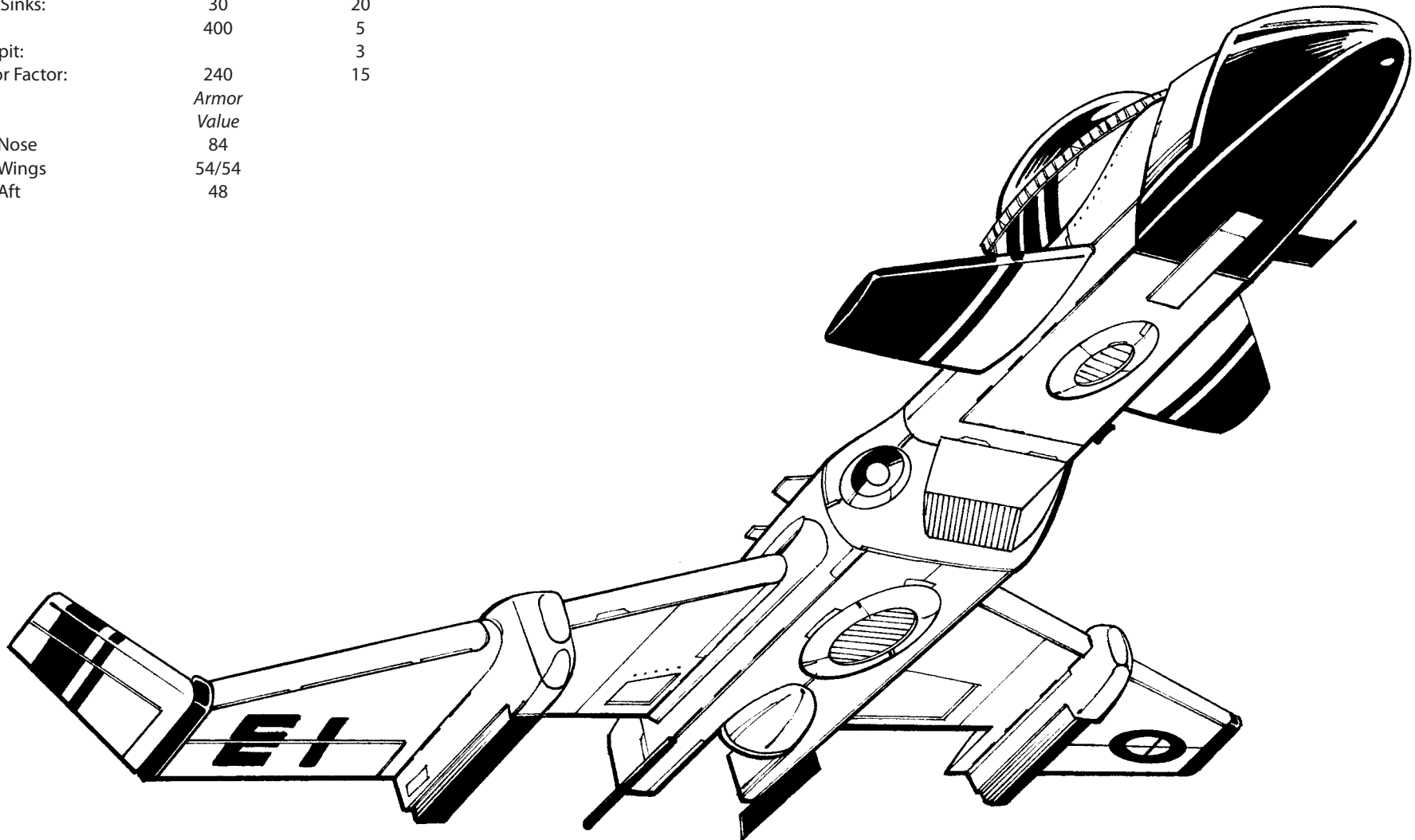

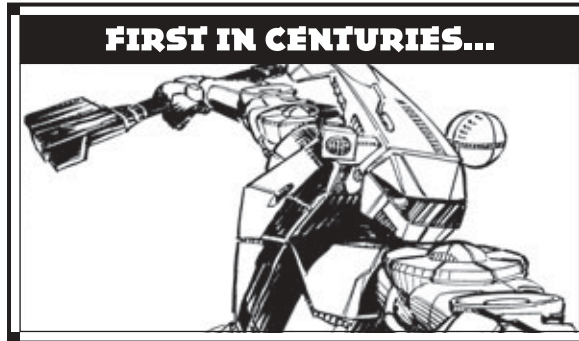

During the first two Succession Wars, the five Great Houses waged total war on a scale that exceeded even the Amaris Civil War. Using every weapon known to man, these two wars devastated numerous systems, rendered hundreds of planets uninhabitable, and reduced mankind's technological base to barely above that of the early Age of War ... on the most advanced planets. Many planets were left worse off.

But that was just the beginning.

Operation Holy Shroud arguably did just as much damage to the Inner Sphere's technological base in five years as the Successor States did to themselves in the first two hundred years of the Succession Wars. While the Inner Sphere destroyed material infrastructure, ComStar's ROM agents assassinated hundreds of researchers and lead engineers. Technological development and reconstruction were set back by years for each and every head researcher, professor, or innovative technician that was murdered. They were all victims of a secret policy aimed at keeping the Inner Sphere in the dark until the day that ComStar could easily swat aside the few remaining House forces and become mankind's savior, ending centuries of warfare.

And yet despite these setbacks, human nature and ingenuity would eventually prevail. The first sign of the Inner Sphere's recovery was the unveiling of the *Merlin* heavy BattleMech design in 3010. Since ROM, along with every other major policy in the Inner Sphere, considered the Outworlds Alliance to be a backwater (even by Periphery standards), no one foresaw that state as being the home of the first new BattleMech design in centuries. [EDITOR'S NOTE: Despite being the first of firsts, I have removed the *Merlin* design from this section as it was recently listed in its original configuration in the *Technical Readout 3058 Upgrade* file, and its placement here would be redundant.]

Thirteen years later Defiance Industries would duplicate the success with the innovative *Hatchetman*. The first design created in the Successor States, not only was the *Hatchetman* important as a sign that the *Merlin* was not a fluke, but it also was truly innovative for the full head-ejection system and for having a melee weapon integrated into the production model. Unbeknownst to anyone at the time, it was also a sign of the burgeoning relationship between Houses Davion and Steiner. While ComStar's inner circle debated reviving Operation Holy Shroud once again, the testing of the *Raven* and *Cataphract* in the Capellan Confederation put an end to the discussion. It was proof that humanity refused to slide backward any further in technology.

However, it was expected that it would still take centuries until the Inner Sphere recovered to the level of the lost Star League. That was, however, until the Gray Death Legion mercenary regiment uncovered and (despite all odds) kept the Star League library database core on the planet Helm and presented it to the Lyran Commonwealth in 3028 (who immediately shared it with the Federated Suns). Shortly thereafter, ComStar struck a military-aid deal with House Kurita to counter the growing Davion-Steiner juggernaut. Though ComStar strove to strip advanced technology from Star League-era 'Mechs before giving them to the Combine, ComStar's sloppiness gave the Combine some examples of advanced technology that the Combine set about reverse-engineering. The Inner Sphere began unlocking secrets hidden for centuries and progressed now by leaps and bounds, and would continue doing so without much difficulty until the former Star League Defense Force, now calling themselves the Clans, invaded.

Humanity, no matter how dark their environs, still moves forward. Listed in this section are the designs that proved this, new designs that surpassed benchmarks by factions that had previously remained technologically stagnant for centuries.

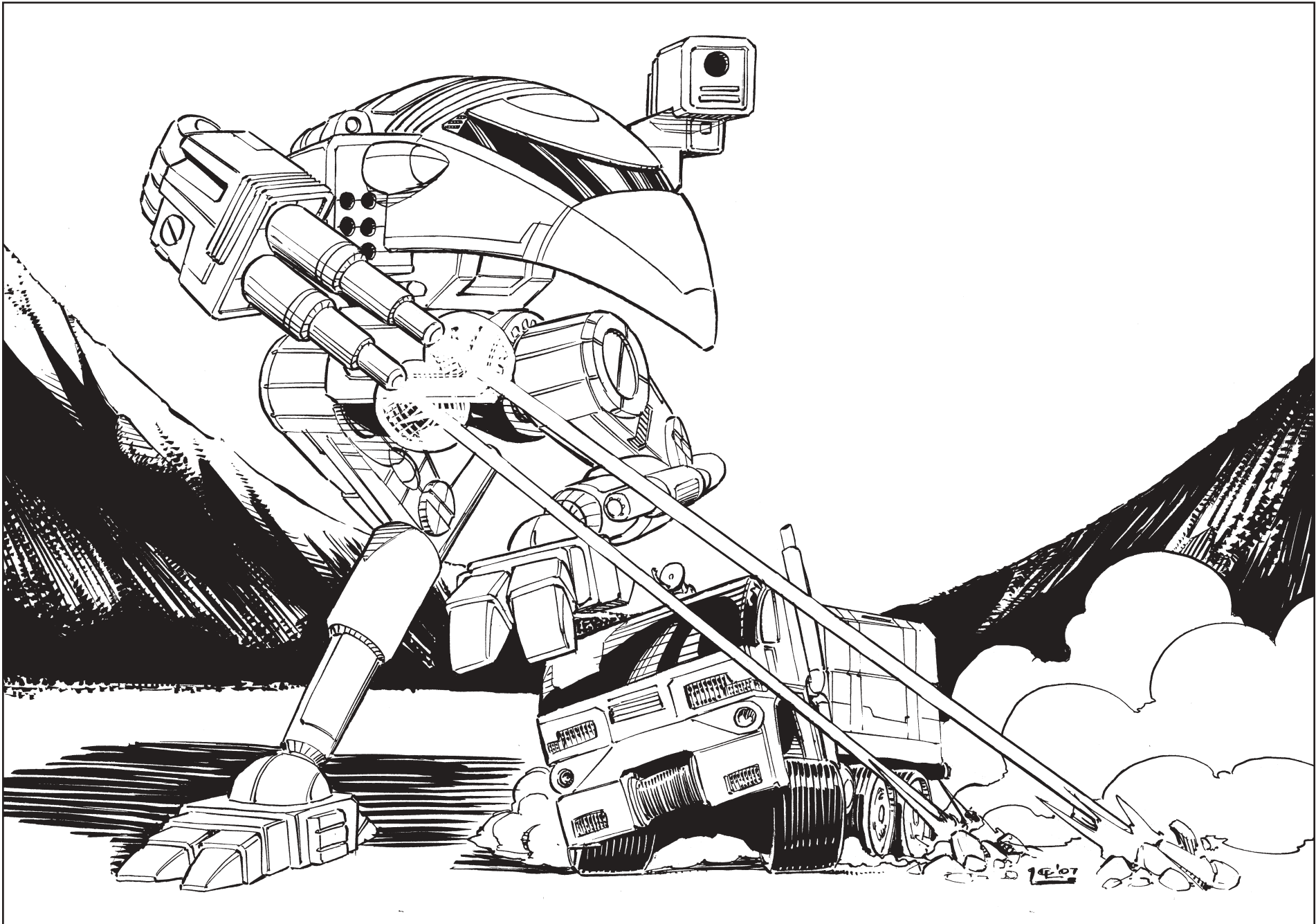

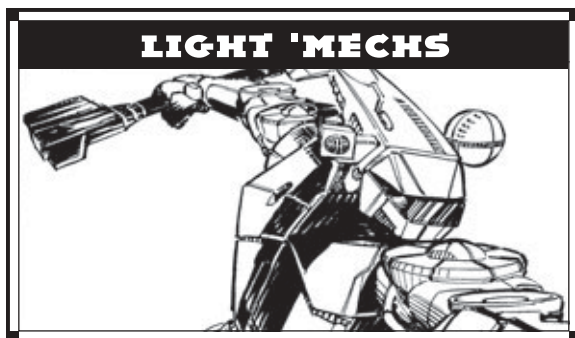

Mass: 35 tons

Chassis: Hellespont Type R

Power Plant: Omni 175

Cruising Speed: 54 kph

Maximum Speed: 86 kph

Jump Jets: None

Jump Capacity: None

Armor: Starshield

Armament:

2 Ceres Arms Medium Lasers

1 Harpoon-6 SRM Launcher

1 Ceres Arms Electronic Warfare X-1 Equipment

Manufacturer: Hellespont Industries

Primary Factory: Sian

Communications System: CeresCom Model 22-A

Targeting and Tracking System: C-Apple Churchill

Overview

Wedged between the Free Worlds League and Federated Suns, the diminutive Capellan Confederation was searching desperately for force multipliers at the end of the Third Succession War. One research and development program was a bold attempt to recreate the sophisticated electronic warfare technology of the long-lost Star League era. Though a technical success, the prototypes were too bulky to install on any of the Confederation's existing BattleMechs.

Rather than abandon a promising technology, Chancellor Maximillian Liao directed his technicians to develop a new design to serve as a platform to carry the electronics into battle. The result was Hellespont Industries' RVN-1X *Raven*.

Capabilities

Lightly armed and armored, the *Raven* leaves combat to other units while it concentrates on its primary mission: providing electronic warfare and countermeasure support at the company level for other BattleMechs. While the company maneuvers, the *Raven* provides ECM cover to mask their movements from the enemy or uses its advanced sensors to scout the way, probing for ambush or other surprises. Once combat is engaged the *Raven* typically stands off, directing artillery or indirect fire.

The *Raven* is literally built around the Ceres Arms electronic warfare package. The sophisticated system has not been without its problems, such as the fact that damage to the electronics can disrupt other systems. Usually this is limited to communications and targeting systems, but occasionally other systems are disabled by powerful electromagnetic pulses.

Deployment

Despite being designed for company-level support, few Capellan companies actually received a permanently assigned *Raven*. Instead, House Liao deployed the *Raven* at the battalion level, attaching it to the command lance as a temporary fifth member. The battalion commander detaches the *Raven* for specific missions to provide electronic warfare support to a company or lance in his command as needed. Some recon lances in prestigious commands have been assigned *Ravens* permanently.

During the Fourth Succession War, House Davion forces captured many *Ravens* as they slashed through the Capellan Confederation. Some of these captured BattleMechs were sent to the New Avalon Institute of Science for reverse engineering, but many others were retained to make up combat losses in the units that captured them. The *Raven* become such a common sight in the AFFS that many civilian observers mistakenly thought the design to be a new Davion 'Mech.

One of the *Raven's* first assignments was to provide EW cover for the units participating in Operation Intruders Communion. A pair of *Ravens* supported the team sent to raid a secret NAIS lab on Bethel. In the face of stiff opposition from elements of the Davion Light Guards, the Capellan commando team successfully made off with prototypes of a new and powerful type of myomer in exchange for the loss of one *Raven*.

Variants

The Federated Suns replaced the temperamental Capellan electronics in many of their captured *Ravens*. Designated the RVN-2X, this variant replaces the EW equipment with a large laser and adds two-and-a-half tons of extra armor.

The Capellan Confederation continued to tinker with the triple-strength myomer taken from the Bethel Labs. House Liao discovered too late that the technology was flawed—they had wasted time and resources upgrading BattleMechs only to see them burst into flames the first time the new myomer came into contact with a catalyst gas. Despite this ignoble start, House Liao continued to experiment with the myomer. The RVN-3X increased its ground speed with this original triple-strength myomer. Because it is not intended for direct combat, the myomer's benefits outweigh the risks.

A second Capellan variant, the RVN-4X, is an attempt to turn the chassis into a pure combat unit. Removing the EW equipment, the 4X is outfitted with five jump jets, two machine guns, and a ton of ammunition. Armor protection was increased to the chassis' limit.

Notable MechWarriors

Subcommander Jordan Weiss: Fanatically loyal to House Liao, Weiss is an expert scout attached to the Capellan Hussars. Jordan's joy at being honored with the assignment to pilot a new *Raven* cooled somewhat following his experiences fighting the Tooth of Ymir mercenary regiment on Betelgeuse.

Caught in the crossfire, Weiss' *Raven* was hit several times. The EW system overloaded, shorting out all his control systems. More damage jammed the canopy, trapping Weiss in a motionless BattleMech in the middle of the battlefield. He spent the next thirty minutes in darkness receiving electric shocks from short-circuiting electronics, fighting with a malfunctioning waste management system, and praying no one shot at his disabled 'Mech.

RVN-1X RAVEN

Type: **Raven**

Technology Base: Inner Sphere

Tonnage: 35

Battle Value: N/A

Equipment

		Mass
Internal Structure:		3.5
Engine:	175	7
Walking MP:	5	
Running MP:	8	
Jumping MP:	0	
Heat Sinks:	12	2
Gyro:		2
Cockpit:		3
Armor Factor:	64	4
	<i>Internal Structure</i>	<i>Armor Value</i>
Head	3	6
Center Torso	11	8
Center Torso (rear)		4
R/L Torso	8	6
R/L Torso (rear)		3
R/L Arm	6	6
R/L Leg	8	8

Weapons

and Ammo	Location	Critical	Tonnage
2 Medium Lasers	RA	2	2
SRM 6	RT	2	3
Ammo (SRM) 15	LT	1	1
EW Equipment	LT	4	7.5

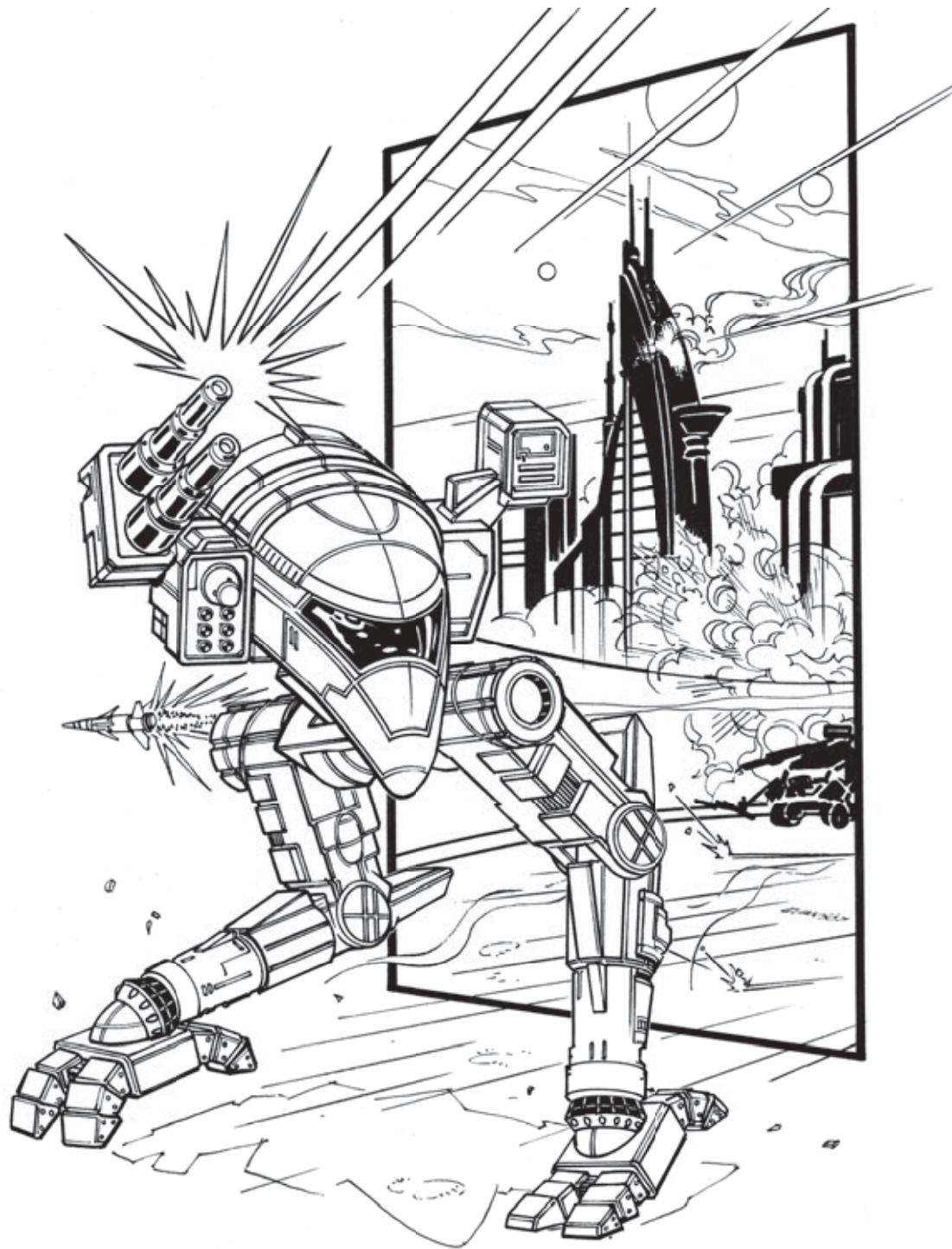

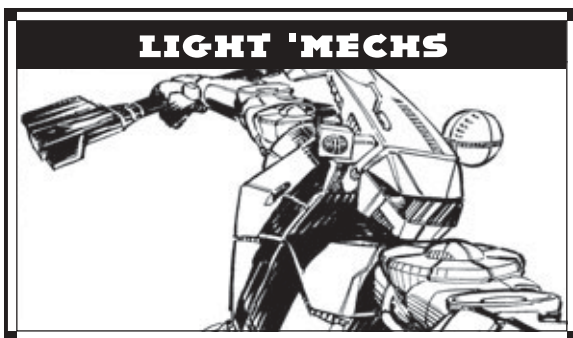

Mass: 35 tons

Chassis: Arc-Royal KH/3

Power Plant: GM 210

Cruising Speed: 64 kph

Maximum Speed: 97 kph

Jump Jets: None

Jump Capacity: None

Armor: Durallex Medium

Armament:

1 Setanta Large Laser

4 Defiance B3M Medium Lasers

Manufacturer: TharHes Industries

Primary Factory: Tharkad

Communications System: O/P Com-22/H47

Targeting and Tracking System: Digital Scanlok 347

Overview

After the success of designing and producing the *Hatchetman* just years prior, Archon Katrina Steiner ordered the massive Commonwealth military-industrial complex to capitalize on the gains made by Defiance Industries to produce a BattleMech capable of hunting down and defeating the Kuritan light 'Mechs known for embarrassing the top-heavy LCAF.

Taking a page from the successful Desert Knights project, the Kell Hound mercenary group, known for its unwavering loyalty to the current Archon and House Steiner, was selected to test an experimental BattleMech design in early 3028. Unlike the *Hatchetman* produced by Defiance Industries, which had extensive help from a Federated

Suns mercenary-scientist group, the *Wolfhound* was almost entirely of Commonwealth origins, with only the full-head cockpit ejection system needing outside assistance.

Capabilities

The *Wolfhound* contains many features to address extended campaigns. It is armed entirely with energy weapons, meaning the 35-ton 'Mech never needs to retire from the field for re-supply. A single large laser allows it to maul most light 'Mech designs at range, such as its prime foe the *Jenner*, while four medium lasers grant the *Wolfhound* a hefty short-ranged punch. One of the medium lasers is mounted rearward, allowing the *Wolfhound* to return fire against fast units that happen to get into that traditional blind spot. Though the design runs hot with only ten heat sinks, competent MechWarriors simply rotate their weapon usage depending on their current fighting range. When facing *Jenners*, *Wolfhounds* generally stay at range, but close in under the minimum range of the particle projection cannons of opposing *Panthers*.

Like the jointly designed *Hatchetman*, the *Wolfhound* also possesses a full-head ejection system, allowing the MechWarrior to safely eject in a wide variety of hostile environments. Despite requiring the 'Mech to be in a vaguely upright position with the projected flight path free of obstructions, this radical system has already saved countless pilots' lives.

Deployment

Eventually *Wolfhounds* made their way into the ranks of the mercenary brigade of Wolf's Dragoons in addition to the Kell Hounds testing program. These two units went on to test the design through the rigors of the Fourth Succession War, and its performance impressed many observers. They particularly excelled against the Combine's primary light mechs, the *Panthers* and *Jenners*. After the war, the Federated Commonwealth Alliance ordered large numbers of *Wolfhounds* to equip light units in both Alliance militaries. By the War of 3039, the *Wolfhounds* were spread between the two Houses' militaries and their most loyal mercenary units. Unlike many other designs, the *Wolfhounds* took very few casualties during that one-

year engagement, and only a handful made it into Kuritan hands. The Combine was impressed with the machine but was too prideful to copy an "inferior" House's design, so the Combine instead dissected all the 'Mechs in an attempt to counter the *Wolfhound*, leading to the development of the advanced *Wolf Trap* almost a decade later.

Variants

Being such a new design, no factory-produced variants for the *Wolfhound* are known to exist, though there are reports of individual MechWarriors exchanging the rear laser for an extra heat sink, or instead having it repositioned to fire forward.

Notable MechWarriors

Major Daniel Allard: A member of the famous Kell Hounds, Daniel Allard was given the first prototype *Wolfhound* to test pilot while still a captain after the destruction of his *Valkyrie* in 3027. He would later on go on to use this machine to fight in many famous battles before being promoted to operational commander of the unit.

Force Commander Melissa Berret: Despite the heavy fighting of the War of 3039, the sole *Wolfhound* employed by a non-Federated Commonwealth unit (until the Clan Invasion) was not under a Combine banner, but rather in the Free Worlds League. Despite suffering grievous casualties on Marcus at the hands of the Third Crucis Lancers, the Twenty-fifth Marik Militia had a single success during the campaign; a diversionary raid by then-Captain Berret. Her lance drew off several companies of Lancer light BattleMechs in an attempt to ease the pressure on her regiment by engaging in a hit-and-run battle, striking supply depots behind the Lancers' lines. When the Twenty-fifth's DropShips finally arrived, Berret's lance made its way back to the rendezvous, dragging a *Wolfhound* with a breached cockpit along with them. Promoted to fill in the holes made by the many casualties, Force Commander Berret now pilots the 'Mech design, nicknamed "Small Favors," as a morale booster for the devastated unit.

WLF-1 WOLFHOUND

Type: **Wolfhound**

Technology Base: Inner Sphere

Tonnage: 35

Battle Value: 932

Equipment

Internal Structure:

Engine: 210

Walking MP: 6

Running MP: 9

Jumping MP: 0

Heat Sinks: 10

Gyro: 3

Cockpit: 3

Armor Factor: 120

Mass

3.5

9

0

3

3

7.5

	Internal Structure	Armor Value
--	--------------------	-------------

Head	3	9
------	---	---

Center Torso	11	16
--------------	----	----

Center Torso (rear)		6
---------------------	--	---

R/L Torso	8	11
-----------	---	----

R/L Torso (rear)		5
------------------	--	---

R/L Arm	6	12
---------	---	----

R/L Leg	8	16
---------	---	----

Weapons

and Ammo

Location	Critical	Tonnage
----------	----------	---------

Large Laser	RA	2	5
-------------	----	---	---

Medium Laser	RT	1	1
--------------	----	---	---

Medium Laser	LT	1	1
--------------	----	---	---

Medium Laser	CT	1	1
--------------	----	---	---

Medium Laser	CT (R)	1	1
--------------	--------	---	---

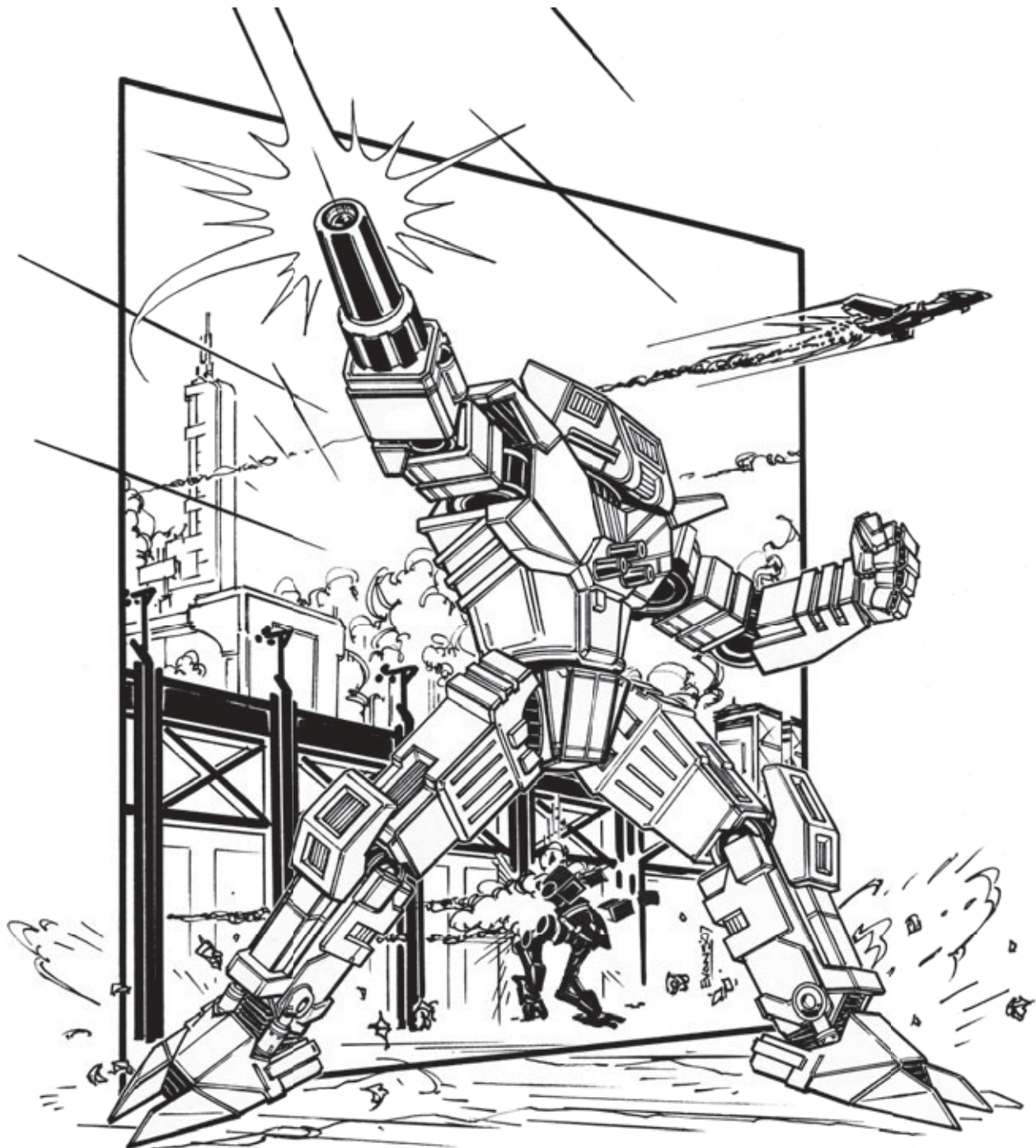

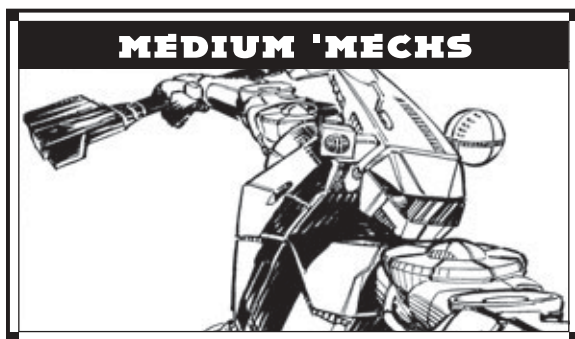

Mass: 45 tons
Chassis: Chariot Type II
Power Plant: GM 180
Cruising Speed: 43 kph
Maximum Speed: 64 kph
Jump Jets: Luxor 2/Q
Jump Capacity: 120 meters
Armor: Durallex Medium
Armament:
1 Defiance Killer Autocannon
2 Defiance B3M Medium Lasers
Manufacturer: Defiance Industries
Primary Factory: Hesperus II
Communications System: TharHes Thalia HM-22
Targeting and Tracking System: TharHes Ares-8a

Overview

The HCT-3F *Hatchetman* is a very unusual 'Mech. Although commissioned by the Lyran Commonwealth, the design itself originates from the New Avalon Institute of Science in the Federated Suns. Carrying the first true innovations in BattleMech design since the fall of the Star League, the *Hatchetman* caused a stir throughout the Inner Sphere when Defiance Industries started production in 3023.

Capabilities

Armed with its trademark "hatchet", the *Hatchetman* excels in urban combat. The Killer Autocannon is a reliable and efficient weapon, and it is buried in the 'Mech's right torso for excellent protection. Twenty rounds of ammunition are held in two ten-shot clips—a design feature borrowed

from the Federated Suns' *Enforcer*. Two arm-mounted medium lasers are included to support the main gun.

While relatively slow, the 'Mech's jump jets help offset this weakness when the *Hatchetman* is deployed in its intended environment. However, in open terrain this lack of speed and light armor can put the *Hatchetman* at a disadvantage.

The *Hatchetman's* versatile Ares-8a battle computer can track approaching aerospace fighters and advise its pilot how to direct fire at them. The system's sensors are mounted in the armored globe attached to the left side of the 'Mech's head.

The most unusual feature of the *Hatchetman* is its revolutionary ejection system. The entire head assembly is ejected from the damaged 'Mech on rocket motors that propel it clear. Theoretically safer than the traditional ejection seat, the system has proven popular and has been incorporated into the new *Wolfhound* as well. The only drawback to this novel ejection system is that the wounded 'Mech must be either standing, kneeling, or sitting with its head upright, and the flight path must be free of obstructions.

Deployment

The first production runs of the *Hatchetman* were used to supplement Lyran units garrisoning larger cities. Although not intended for general deployment, early successes prompted other units to request the design to replace patchwork Succession War veteran BattleMechs.

As the Commonwealth's ally, the Federated Suns received shipments of the *Hatchetman* just before the Fourth Succession War. Already well versed in the use of the *Enforcer*, the 'Mech soon became a favorite of units such as the First Kathil Uhlans and the Crucis Lancers.

The *Hatchetman* first saw combat when elements of the Fourth Proserpina Hussars raided a city on the Lyran planet of Sevren. Colonel Kester's battalion of the Twenty-sixth Lyran Guards was stationed there, and as luck would have it they had just received the new design. Using his *Hatchetmen* as a diversion, Kester lured the attackers into a huge industrial park. Meanwhile the rest of the battalion evacuated a hospital and university complex that was in the enemy's path.

It was amidst the towers and alleys of the industrial complex that the *Hatchetman* earned its name. As

enemy 'Mech units sought to flush out the Lyran Guards, *Hatchetmen* would appear from hiding to catch Combine MechWarriors by surprise—either shooting at point-blank range or cleaving a 'Mech in two.

Variants

The *Hatchetman* is one of the designs that the embryonic Federated Commonwealth earmarked for upgrading with recovered technology. A number of prototype refits replaced the autocannon with an experimental LB-X weapon.

The Draconis Combine was able to construct a *Hatchetman* prototype based on captured Lyran equipment, but the Kuritan techs were unable to reproduce the 'Mech's unique ejection system. The design met with a lukewarm reception among Combine test pilots, and the project was eventually canceled.

Notable MechWarriors

Leutenant Helimar Senton: A member of Colonel Kester's battalion, Leutenant Senton was the first MechWarrior to get a confirmed kill in a *Hatchetman*. Since his victim was an officer and the 'Mech's gruesome cleaving was captured on camera by a local news team, Senton became a local hero.

Over the years that have followed, Senton and his dark green *Hatchetman*, "*Alien*", have earned battle honors in numerous campaigns on the Kurita front, including the fighting on Kandis, Engadin, and Alnasi.

MechWarrior Austin Vorster: A member of Davion's elite McKinnon's Raiders since 3023, Austin Vorster has served with the company almost his entire adult life. Years of heavy fighting have transformed Austin from a wet-behind-the-ears greenhorn into a MechWarrior who has earned the respect of his peers and superiors.

Austin's *Hatchetman* was previously assigned to the NAIS Cadet Cadre, where it was the subject of several experimental modifications. The 'Mech mounts three medium lasers on the left arm and served as a test bed for a prototype LB 10-X autocannon.

HCT-3F HATCHETMAN

MEDIUM 'MECHS

229

Type: **Hatchetman**

Technology Base: Inner Sphere

Tonnage: 45

Battle Value: 854

Equipment

Internal Structure:

Engine: 180

Walking MP: 4

Running MP: 6

Jumping MP: 4

Heat Sinks: 11

Gyro: 2

Cockpit: 3

Armor Factor: 104

Internal Structure	Armor Value
--------------------	-------------

Head	3	6
------	---	---

Center Torso	14	14
--------------	----	----

Center Torso (rear)		4
---------------------	--	---

R/L Torso	11	14
-----------	----	----

R/L Torso (rear)		4
------------------	--	---

R/L Arm	7	11
---------	---	----

R/L Leg	11	11
---------	----	----

Mass

4.5

7

1

2

3

6.5

Weapons

and Ammo

Location	Critical	Tonnage
----------	----------	---------

AC/10	RT	7	12
-------	----	---	----

Ammo (AC) 20	CT	2	2
--------------	----	---	---

Medium Laser	RA	1	1
--------------	----	---	---

Medium Laser	LA	1	1
--------------	----	---	---

Hatchet	RA	3	3
---------	----	---	---

Jump Jets	RL	2	1
-----------	----	---	---

Jump Jets	LL	2	1
-----------	----	---	---

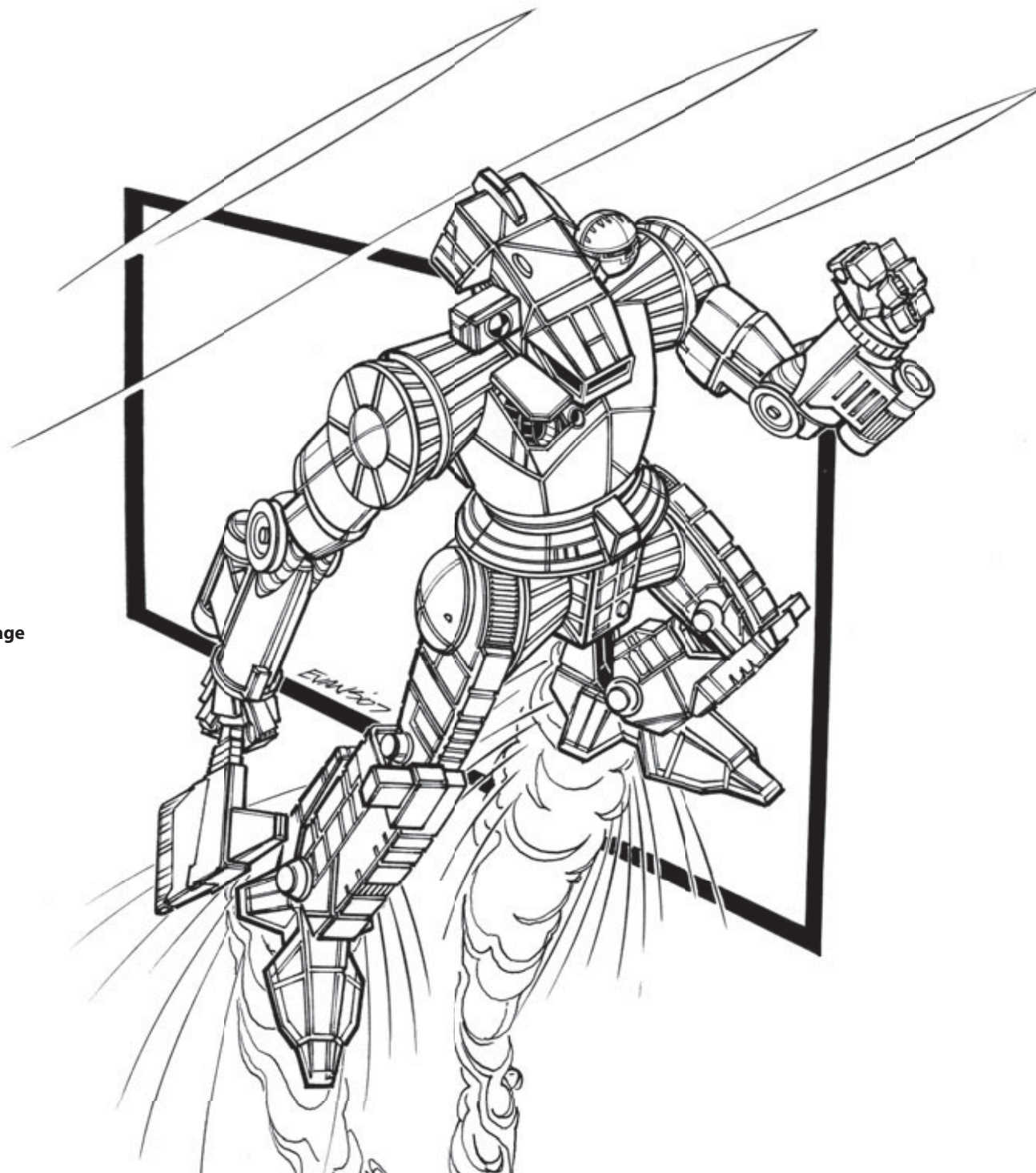

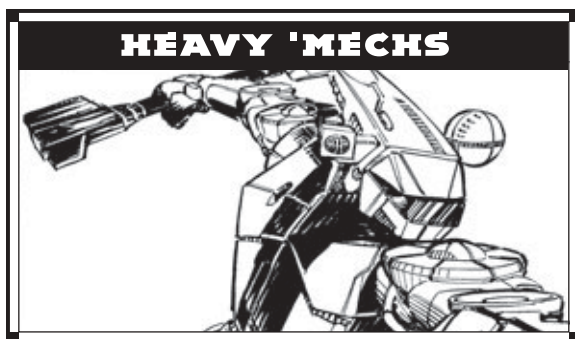

Mass: 70 tons

Chassis: Earthwerks CTF

Power Plant: VOX 280

Cruising Speed: 43 kph

Maximum Speed: 64 kph

Jump Jets: None

Jump Capacity: None

Armor: Kallon Royalstar

Armament:

1 CeresArms Smasher PPC

1 SarLon MaxiCannon Type 10

4 CeresArms Medium Lasers

Manufacturer: Earthwerks Incorporated

Primary Factory: Tikonov, Grand Base

Communications System: CommuTech Multi-Channel 10

Targeting and Tracking System: BlazeFire Sightlock

Overview

Carver V fell to the Free Worlds League in 2953, stripping the Capellan Confederation of vital heavy and assault BattleMech production lines. The battles to liberate the world would rage for three years, and when the dust settled, the Carver V factories had been reduced to smoking piles of rubble. As a result, the Confederation found itself desperately short of heavy BattleMechs during the final years of the Third Succession War. Thus the *Cataphract* design was born from the Capellan Confederation's need for new heavy BattleMechs. But what should have been one of House Liao's proudest achievements of the thirty-first century became a symbol of the Confederation's most embarrassing defeat.

Capabilities

Ruined by the Succession Wars, the Confederation's industrial base had been ravaged to the point that it was almost incapable of manufacturing anything bigger than the *Vindicator*. However, a number of factories could still manufacture parts. It was from this mishmash of available components that the *Cataphract* was born.

Unkindly given the nickname "FrankenMech," on paper the *Cataphract* certainly resembles the shambling piles of jury-rigged parts that occasionally graced the battlefields of the Succession Wars. The legs, torso, and right arm are based on the *Marauder*, and many *Phoenix Hawk* components have also been incorporated. The left arm was originally the right arm from a *Shadow Hawk* (the first prototype still had the hand actuator assembly in place). But unlike the familiar jury-rigged mechanical nightmares, the *Cataphract* had been carefully designed and the parts engineered for their role on the machine. Perhaps the result was not exactly aesthetically pleasing, but it was both functional and (more critically) something that could be built by the Confederation.

Layered with armor, the *Cataphract* can easily absorb damage, but even more importantly it can deal it out too. At longer ranges the CeresArms Smasher PPC (borrowed from the *Vindicator*) and the SarLon MaxiCannon combine to provide a vicious punch. Close in, a quartet of CeresArms medium lasers provide short-range firepower to both the front and rear.

Deployment

The *Cataphract* was intended to become the Capellan Confederation's standard heavy BattleMech, but the loss of Tikonov during the Fourth Succession War derailed those plans. It was the troops of House Davion who received the design in quantity. Many of the commands that participated in the incredibly successful Operation Rat rebuilt using equipment captured or manufactured on the many Capellan worlds that fell to the triumphant AFFS. The *Cataphract* became a common sight in the ranks of the Crucis Lancers, and the appearance of a Capellan BattleMech in Davion ranks caused Kurita troops some confusion during the fighting on the Draconis frontier in 3039.

Similarly, when the St. Ives Compact broke away from the Capellan Confederation, a number of prototype *Cataphracts* fell under the control of the St. Ives Lancers.

The defeats of the Fourth Succession War destroyed Chancellor Maximilian Liao's last tenuous hold on reality. Romano, his daughter, assumed control of the pitiful remnants of the Capellan Confederation. Under her leadership the commercial factories of Betelgeuse were converted to more "important" duties. With torture and execution as daily object lessons, the (surviving) workers' frenzied efforts had the *Cataphract* coming off the production line by 3032—just in time to participate in the counteroffensive against the Andurien invaders.

Variants

The CTF-2X added two tons of armor at the expense of two heat sinks. A Firmir MaxiLase large laser replaced the PPC, and the torso lasers fire forward. The arm-mounted medium lasers were replaced by a Hovertec Quad SRM 4 launcher on the left arm. The 2X also carries an extra ton of autocannon ammunition.

Notable MechWarriors

Sergeant Major George Lytton: As members of the elite McKinnon's Raiders (also known as the Fox's Teeth), the Lytton family have served as bodyguards to the McKinnons since the start of the Succession Wars. Lytton's father fell at the Fourth Battle of Harrow's Sun while guarding Ross McKinnon. A grim and powerfully built man, George Lytton serves in the same role, guarding Ian McKinnon's back.

One of the first prototype *Cataphracts* off the production line, CTF2X00013—or "*Lucky Thirteen*" as it is better known—was captured during the defense of the walled city of Tikograd. The CTF-2X variant was given to George as a replacement for his damaged and aging *Warhammer*. Lytton was more than happy with his new BattleMech—once the technicians had corrected all the shoddy Capellan workmanship. *Lucky Thirteen* was later fitted with an experimental ER large laser and three experimental "freezers."

CTF-1X CATAPHRACT

Type: **Cataphract**

Technology Base: Inner Sphere

Tonnage: 70

Battle Value: 1,303

Equipment

Internal Structure:

Engine:

Walking MP:

Running MP:

Jumping MP:

Heat Sinks:

Gyro:

Cockpit:

Armor Factor:

280

4

6

0

16

3

3

176

Internal
Structure

Armor
Value

Head

3

9

Center Torso

22

26

Center Torso (rear)

9

9

R/L Torso

15

16

R/L Torso (rear)

6

6

R/L Arm

11

22

R/L Leg

15

22

Weapons

and Ammo

Location

Critical

Tonnage

PPC

RA

3

7

Medium Laser

RA

1

1

Medium Laser

RT (R)

1

1

AC/10

RT

7

12

Ammo (AC) 10

RT

1

1

Medium Laser

LT (R)

1

1

Medium Laser

LA

1

1

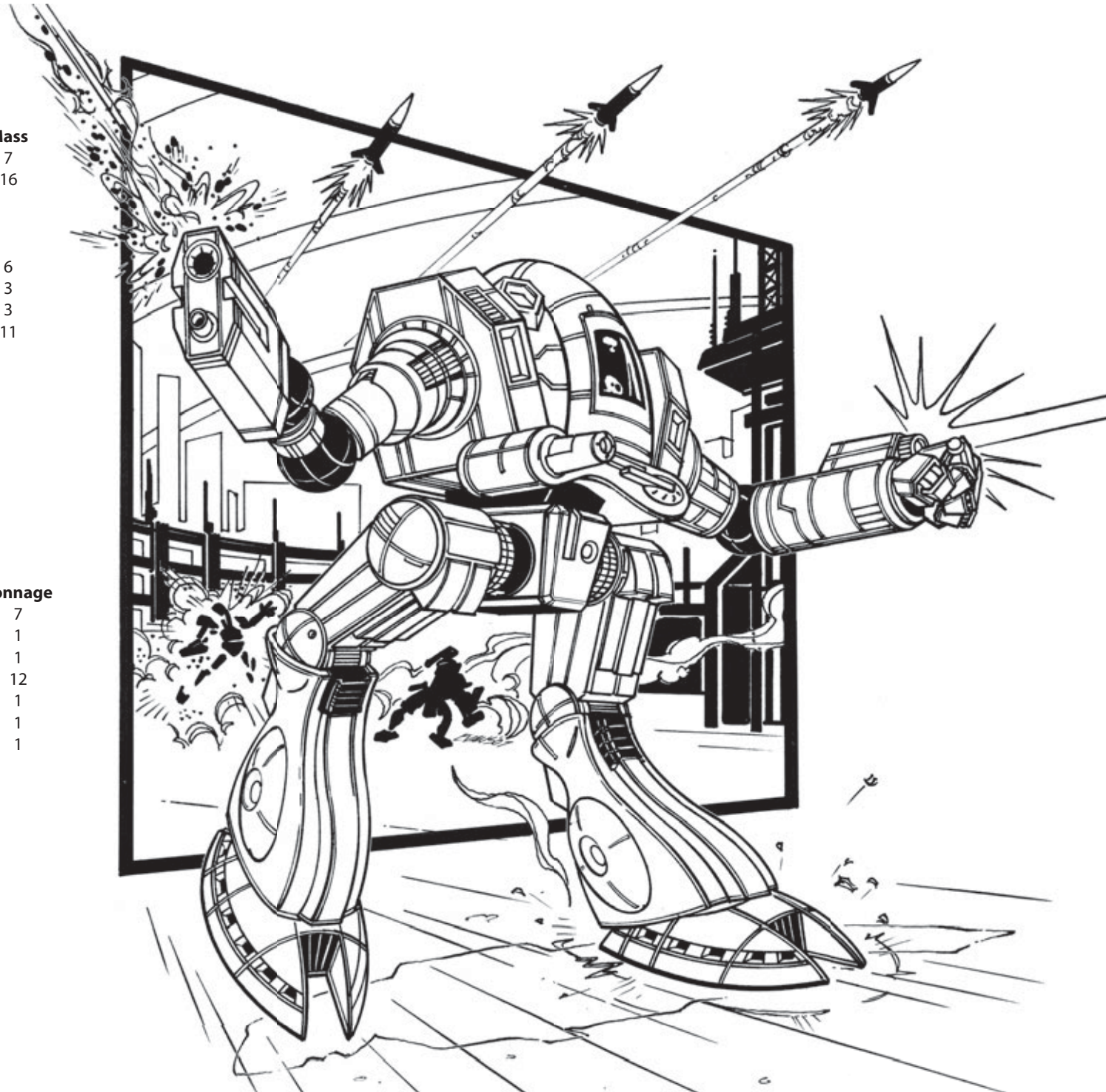

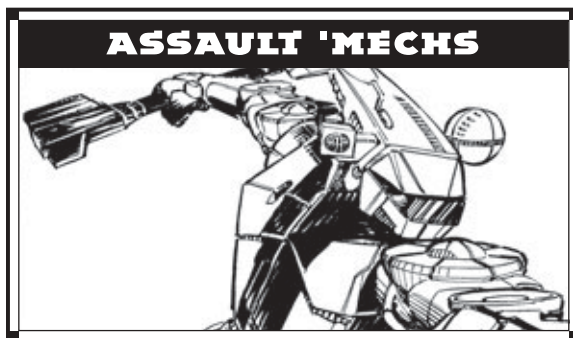

Mass: 80 tons

Chassis: Earthwerks VOL

Power Plant: Pitban 320

Cruising Speed: 43 kph

Maximum Speed: 64 kph

Jump Jets: None

Jump Capacity: None

Armor: Mitchell Argon

Armament:

2 Tiegart PPCs

2 Bical-6 SRM 6 Racks

Manufacturer: Luthien Armor Works

Primary Factory: Luthien

Communications System: Colmax 90

Targeting and Tracking System: Garret D2j

Overview

When ComStar gifted the Combine with hundreds of SLDF BattleMechs, the future Coordinator of the Draconis Combine was not content with just a short-term influx of war materiel. He desired long-term advantages in capabilities. Several *Thugs* accidentally left with Star League technology by sloppy ComStar technicians were sent to Luthien Armor Works, where engineers were charged with reverse-engineering the advanced technology as secretly as possible. Rather than convert an assembly line to produce an all-new chassis, the engineers adopted the *Thug's* weaponry to the otherwise shunned *Charger*, for which the Combine had a ready assembly line.

Using the *Charger* chassis, prototype HTM-26Ts were sent for field-testing just in time for the War of 3039. The lessons learned would be incorporated into the main production model, the HTM-27T, when the AI Na'ir endo-steel facility was re-built several years later.

Capabilities

Despite the technological hurdles engineers faced, the resulting *Hatamoto-Chi* remains an impressive 'Mech. Its pair of particle projection cannons was considered at the time among the best main armament possible for a 'Mech of its size, and the fourteen-and-a-half tons of armor was respectable. The downside to this protection and armament is the design's limited heat dissipation. Only seventeen heat sinks cooled down the 'Mech, leaving a *Hatamoto-Chi* running warm if it fired both its main weapons while on the move. This was a result of the concessions needed to retain the *Charger's* conventional chassis instead of the *Thug's* original endo-steel.

The *Hatamoto-Chi* kept the Star League *Thug's* full-sized SRM racks, supplied by a single ton of ammunition. Many pilots protested the limited ammunition, but designers claimed this was intentional to force the pilots to stay at range, reducing the chances of a destroyed *Hatamoto-Chi* prototype falling into Allied hands. Since many high-ranking officers and commanders who were supposed to stay out of intense fighting were assigned these prototypes initially, some accepted this reasoning, but others remained intransigent.

Deployment

The HTM-26T only had a single limited run prior to the War of 3039, mainly prototypes distributed to the various regiments for extensive testing. Their appearance confused the Allied battle-computers, which mistook them for *Chargers*. After the War of 3039 was over, groups of MechWarriors were brought in for feedback on the design's performance. During a heated exchange between the *Hatamoto-Chi's* pilots and LAW observers, the MechWarriors pointed out the numerous occasions the BattleMech ran out of SRM ammunition in the middle

of a battle, while the observers dryly noted that this also prevented the destruction of nearly a dozen machines, as after-action repairs showed that internal damage had penetrated not only the empty ammunition bay, but also the location where a secondary bay was intended to be placed by designers had they the weight to spare.

The 27T Model appeared early in the 3040s, ending the debate for good. The ability to mass produce endo-steel would allow the design to finally increase the missile supply, though overheating would still be an issue since the Combine could not mass produce double heat sinks for quite sometime after the Clan Invasion had commenced.

Variants

Luthien Armor Works took advantage of the roomy, modular torso that came from the *Charger* chassis to create a plethora of variants. While some mounting autocannons were attempts at duplicating designs the DCMS did not have access to, others (such as mounting LRM launchers instead of SRM racks, or a large laser) were made by LAW to produce a design that could be purchased in entirely self-contained units instead of worrying about supplies from subcontractors. This would contribute to the confusion of allied troops, as their intelligence gatherers could not pin down the capabilities of the *Hatamoto-Chi*, or even if it was just a stylized *Charger*.

Notable MechWarrior

MechWarrior Krystal Lutheran: A member of the Eighth Donegal Guards, MechWarrior Krystal Lutheran was credited with the first destruction of a *Hatamoto-Chi* during the fighting on Altai. She was also credited with the second and third kills over several days of fighting but reportedly grew more and more frustrated as she believed she was merely destroying the same one over and over, only to find it appearing on the battlefield rebuilt with only superficial scars in the next day or two (entirely possible, given the ease with which the *Charger* and *Hatamoto-Chi* could be repaired). She would be killed in action by that same *Hatamoto-Chi* via a PPC bolt to her *Archer's* cockpit after seven days of constant fighting.

HTM-26T HATAMOTO-CHI

Type: **Hatamoto-Chi**

Technology Base: Inner Sphere

Tonnage: 80

Battle Value: 1,536

Equipment

Internal Structure:

Engine: 320

Walking MP: 4

Running MP: 6

Jumping MP: 0

Heat Sinks: 17

Gyro: 4

Cockpit: 3

Armor Factor: 232

Mass

8

22.5

7

4

3

14.5

*Internal
Structure* *Armor
Value*

Head 3 9

Center Torso 25 33

Center Torso (rear) 10 10

R/L Torso 17 24

R/L Torso (rear) 8 8

R/L Arm 13 25

R/L Leg 17 33

Weapons

and Ammo

Location **Critical** **Tonnage**

PPC RA 3 7

PPC LA 3 7

SRM 6 RT 1 3

Ammo (SRM) 15 RT 1 1

SRM 6 LT 1 3

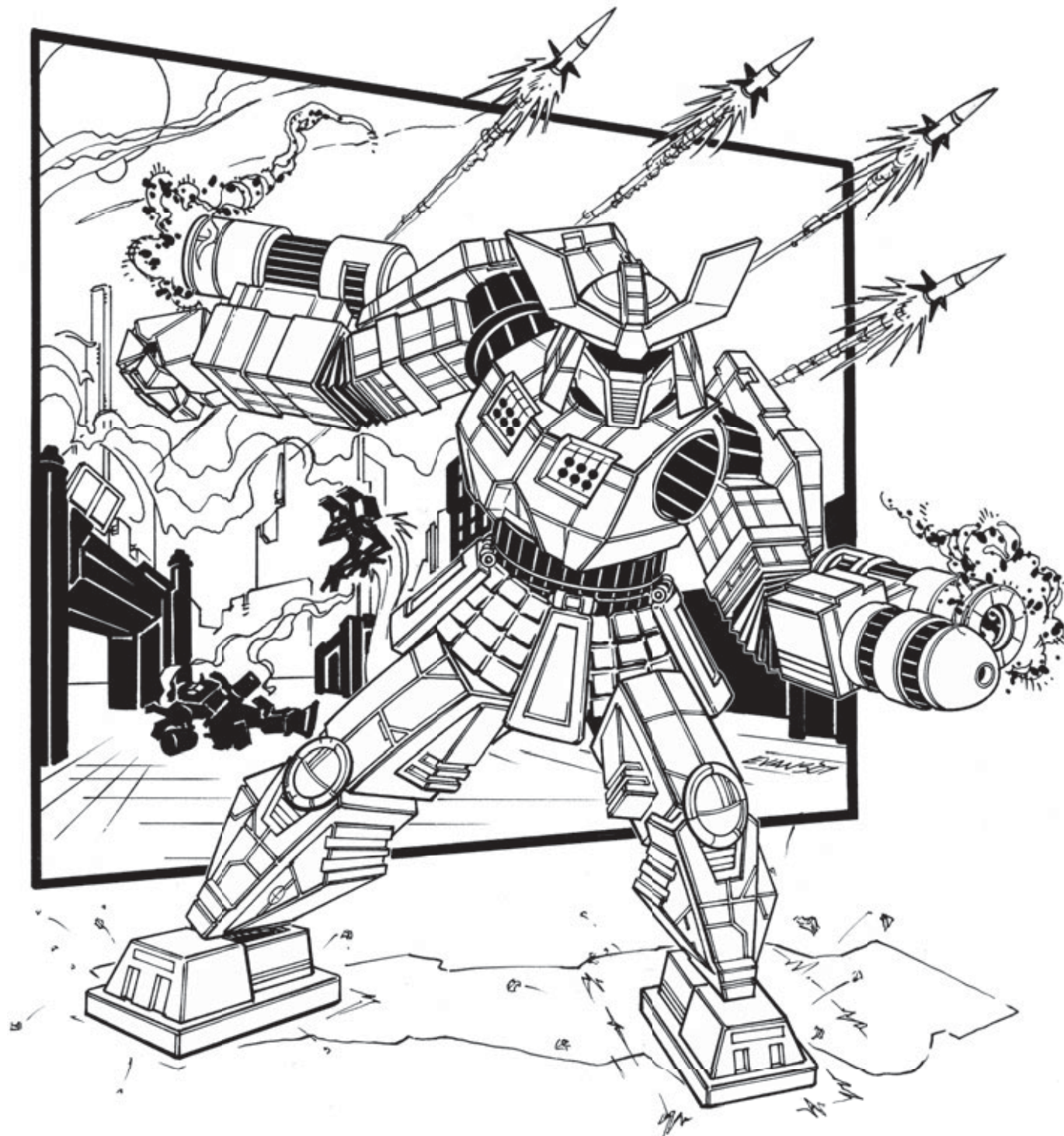

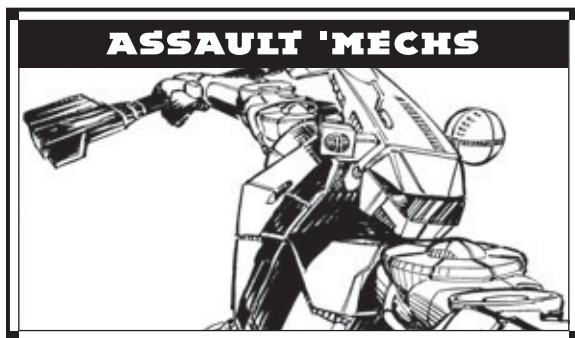

Mass: 90 tons

Chassis: Alshain Class 100-X

Power Plant: Hermes 270

Cruising Speed: 32 kph

Maximum Speed: 54 kph

Jump Jets: None

Jump Capacity: None

Armor: Wakazashi Standard Plate with CASE

Armament:

2 Tronel VI-X Large Lasers

2 Holly Long Range Missile 10 Racks

4 Imperator Smoothie-2 Autocannons

Manufacturer: Luthien Armor Works

Primary Factory: New Samarkand

Communications System: Sipher Security II

Targeting and Tracking System: Matabushi Sentinel-4

Overview

In 3036, Luthien Armor Works participated in Project *Daboku* ("bruiser"), along with several senior-ranking officers, scientists, researchers and even a group of grad students. Originally a think-tank project, this small group was tasked by the Coordinator to examine the Star League technology gained from the Helm Memory Core as well as whatever equipment the Dragon had managed to acquire from the recent ComStar deal brokered by Theodore Kurita.

Doomed from the start because of the tank's highly charged political mix of members, the best result was the design and specifications for a new class of assault 'Mech. The *Daboku* was conceived as a ranged-combat 'Mech

along the same functionary lines as IBMU's *Awesome* design (even copying the silhouette aesthetic); uninspired and desperate to try something, the project was shoved into LAW's hands based solely on their recent success with the *Hatamoto* series.

The *Daboku* debuted to little fanfare in 3038 and almost immediately earned the derision of nearly every DCMS pilot. A short test-run of 300 was produced before the line was closed down and retooled. *Daboku* pilots made every effort to inform LAW of the design's flaws down to the smallest detail; quite often a debriefing would contain several pages of detailed nitpicks and errors.

Capabilities

Conceived as a long-range gunnery platform, the *Daboku* mounted dual Tronel large lasers paired with Holly LRM racks. Four light autocannons added little firepower to the design, though with such a preponderance of long-range weapons, the *Daboku* could easily snipe at opponents from afar. The problem was that the weapons were underpowered and prone to excessive overheating, thanks to the inadequate number of heat sinks.

A large portion of the *Daboku's* problem was trying to copy the *Awesome* and expecting it to work with a different weapons mix and system construction. The frame was too small to adequately handle the autocannons' multiple weapon feeds; adding to the problem was the constant jamming of the Holly loading mechanisms. The Tronel lasers were notorious for overheating, and due to design incompatibility could not mount an adequate heat baffle to the charging mechanism. As a result, the Tronel system tended to short-out the targeting circuitry.

The biggest problem, however, was the new CASE technology LAW tried to copy from several Star League 'Mechs that ComStar "mis-shipped." Rather than properly re-engineering the technology, LAW technicians basically copied the system over from one 'Mech to the other; neglecting the fact that CASE—while universal in concept—has several sensors that need to be tweaked to each 'Mech to properly monitor and protect the machine and its pilot.

As a result, the CASE was improperly installed in nearly every single *Daboku*. When the lower centerline armor plate and frame was hit with enough kinetic force, it would

"ghost" a signal to the safety mechanisms, indicating a catastrophic ammunition incident. It would then fire the auto-eject sequence, sending the unsuspecting pilot rocketing into the air, regardless if the system was manually disabled or not. Many DCMS pilots found themselves arcing skyward during routine training exercises if a dummy round hit the lower torso with any type of heavy impact.

Deployment

Dabokus were rushed to the frontlines along the FedSuns border just in time for the War of 3039. With the DCMS pilots ill-informed of the CASE's flaws, many *Dabokus* were lost to pilot ejection despite only suffering moderate armor damage. When the problem became clear, many DCMS pilots sought to disable the auto-eject system, hoping the CASE's passive blast containment would protect them.

As a result of the early losses, the AFFS snapped up quite a bit of *Dabokus* as salvage. With the 'Mechs redeployed with Lyran units along the border, DCMS warriors would often enjoy sniping for the sweet spot to send the unsuspecting enemy pilot into the sky. The Lyrans quickly caught on, however, and most *Dabokus* with the LCAF ended up as spare parts for their own more stable assault designs.

Variants

No variants of the *Daboku* are known to exist, though the chassis would be transformed into the successful *Mauler* in the 3040s.

Notable MechWarrior

Busosenshi Nakisawa Eldersage: Piloting a *Cyclops*, this unremarkable MechWarrior with the Third Dieron Regulars is notorious for being the pilot who actually managed to punch five Lyran *Daboku* pilots out of their salvaged rides. He would close with a *Daboku* and, once engaged in close-quarters combat, punch the centerline sweet spot to eject the pilot. BattleROM footage of this strange but humorous action can still be found on many planetary computer networks.

DCMS-MX90-D DABOKU

Type: **Daboku**

Technology Base: Inner Sphere

Tonnage: 90

Battle Value: 1,290

Equipment

Internal Structure:

Engine: 270 14.5

Walking MP: 3

Running MP: 5

Jumping MP: 0

Heat Sinks: 12 2

Gyro: 3

Cockpit: 3

Armor Factor: 152 9.5

	Internal Structure	Armor Value
--	--------------------	-------------

Head	3	9
------	---	---

Center Torso	29	23
--------------	----	----

Center Torso (rear)		8
---------------------	--	---

R/L Torso	19	15
-----------	----	----

R/L Torso (rear)		5
------------------	--	---

R/L Arm	15	16
---------	----	----

R/L Leg	19	20
---------	----	----

Weapons

and Ammo

	Location	Critical	Tonnage
--	----------	----------	---------

Large Laser	RA	2	5
-------------	----	---	---

Large Laser	LA	2	5
-------------	----	---	---

LRM 10	RT	2	5
--------	----	---	---

Ammo (LRM) 12	RT	1	1
---------------	----	---	---

LRM 10	LT	2	5
--------	----	---	---

Ammo (LRM) 12	LT	1	1
---------------	----	---	---

2 AC/2	RT	2	12
--------	----	---	----

Ammo (AC) 45	RT	1	1
--------------	----	---	---

2 AC/2	LT	2	12
--------	----	---	----

Ammo (AC) 45	LT	1	1
--------------	----	---	---

CASE	RT	1	.5
------	----	---	----

CASE	LT	1	.5
------	----	---	----

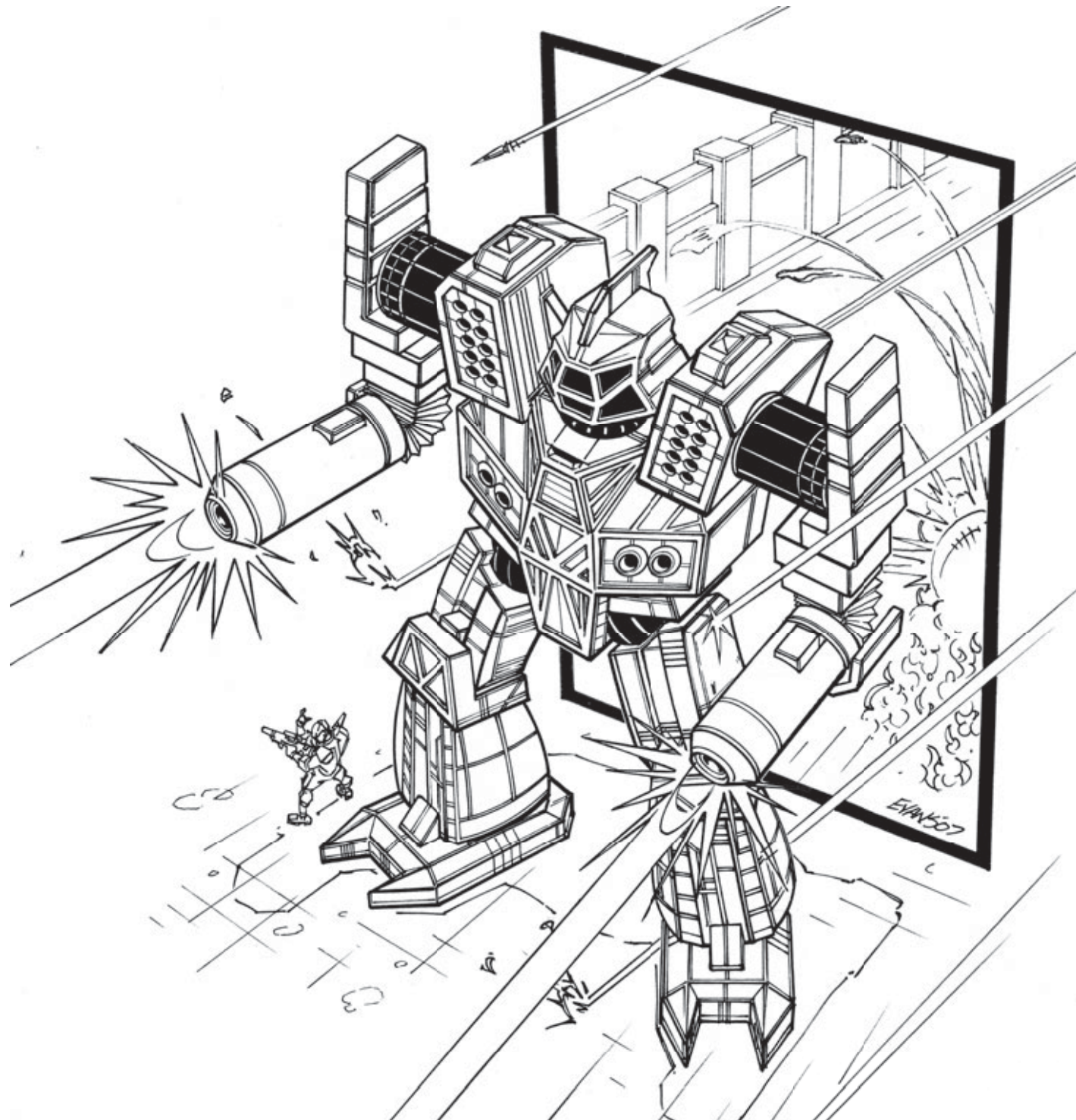

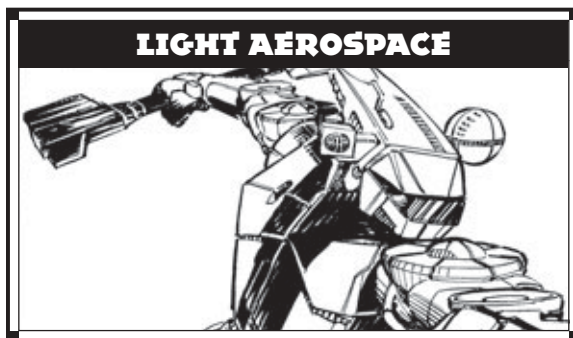

Mass: 40 tons

Chassis: Wakazashi I

Power Plant: Shinobi 240

Armor: Shinobi Standard

Armament:

1 Diverse Optics Type 30 Large Laser

4 Diverse Optics Type 20 Medium Lasers

Manufacturer: Wakazashi Enterprises

Primary Factory: Schuyler

Communications System: Neil 4000

Targeting and Tracking System: Chichester ASR-26

Overview

After the Akira Report was distributed, the *Sholagar's* image among Kuritan pilots dropped dramatically. Mangon Aeronautics scrambled to design and produce a new light fighter design able to replace the *Sholagar*. Declining sales and the massive financial drain of designing an all-new aerospace fighter made the company financially unsound, which led to the takeover by Wakazashi in 3045. Wakazashi, upon examining their new acquisition, discovered the *Sai* project, which had produced a single prototype. Looking to capitalize on that groundwork, Wakazashi began producing duplicates of the prototype for widespread field-testing.

Capabilities

Avoiding the failed aerodynamic design of the wings of its predecessor, the *Sai's* more traditional shape has allowed it to become a superior atmospheric fighter. Those pilots who fly the *Sai* in atmosphere find it nearly as agile as a conventional fighter.

The main intent of the *Sai* was to combine the best qualities of their most common opponents, the durable *Sparrowhawks* and the hard-hitting *Seydlitz*. Mounting a large laser and a quartet of medium lasers, the *Sai* matches the punch of many medium fighters. The fourteen heat sinks allow it to fire its weapons continuously and the seven-and-a-half tons of armor give it considerable protection, equal to that of the *Sparrowhawk*. The one thing the *Sai* lacks is raw acceleration. Though the Shinobi 240 gives it considerable thrust and turning capability, it is still twenty percent less than its predecessor and its rivals.

Deployment

Only thirty S-3s were produced for field-testing before the Schuyler facility was retooled to use Star League technology in 3048. However, the Draconis Combine would put these original models to good use, sending out small raiding parties to spar with the much-feared *Sparrowhawk* and test the limits of their new fighter.

Variants

The S-3 was in production for too little time to produce any meaningful variants, though some of the original design team proposed a weapons configuration related to that of its predecessor, the *Sholagar*. This would upgrade the main weapon to a PPC and mount short-range missiles in the wings. However, this concept never left the drawing board.

Upgrades

The original S-4, now classified as the S-4X, would be the first known mass-produced aerospace fighter to mount an extra-light engine (until the recent revelation of just how advanced the Star League Royal divisions were). It also mounted state-of-the-art armor, with extended-range large lasers and wing-mounted medium pulse lasers as armament, cooled by twenty-one single heat sinks. Unfortunately, the S-4 factory would quickly fall to Clan Smoke Jaguar during the Clan Invasion. Taking

advantage of the opportunity to humiliate the Combine further, Clan pilots would go to refit the *Sai* with Clan technology. This S-4C was fitted with entirely Clan weaponry while the frame was based on a set of blueprints found in the captured facility. This carried two Streak 4 racks in each wing, a nose-mounted extended-range PPC, and fourteen double heat sinks at the expense of some armor.

Upon recovering the plant following Operation Bulldog, Wakazashi, despite all their efforts, could not continue production of the Clan-tech S-4C and downgraded the line to produce a similar version. This was still designated the S-4 and carried an Inner Sphere-model ER PPC with a pair of wing-mounted, Artemis-enhanced SRM launchers.

Two new variants have surfaced since then. The S-7 replaces the missiles with larger MRM pods but downgrades the nose weaponry to a pair of extended-ranged medium lasers and increases the fuel supply by a ton. This version has been seen on many border worlds as a long-range patrol or escort craft. The other variant is known as the S-8. This returns to the original configuration of twin ER medium lasers in each wing and adds a pair of light PPCs in the nose. The S-8 is clad in nine tons of ferro-aluminum armor.

Notable Pilots

Tai-i Reggie Hotspurn: Assigned to field-test one of the S-3 *Sai's* against Federated Commonwealth fighters, *Tai-i* Hotspurn has seen more combat with enemy craft than any other *Sai* pilot. Hotspurn has over a dozen kills to his record and has learned to quickly close and trade blows with *Seydlitzes*, where the *Sai's* superior firepower can disintegrate the *Seydlitz's* light armor quickly. He keeps the short-ranged Davion *Sparrowhawks* at arm's length while the *Sai's* superior range whittles the *Sparrowhawk's* armor away, then closes to shred the denuded Davion fighters with his medium lasers.

Type: **Sai**
 Technology Base: Inner Sphere
 Tonnage: 40
 Battle Value: 959

Weapons and Ammo

Large Laser
 2 Medium Lasers
 2 Medium Lasers

Location	Tonnage	Heat	SRV	MRV	LRV	ERV
Nose	5	8	8	8	—	—
RW	2	3	5	—	—	—
LW	2	3	5	—	—	—

Equipment		Mass
Engine:	240	11.5
Safe Thrust:	8	
Maximum Thrust:	12	
Structural Integrity:	8	
Heat Sinks:	14	4
Fuel:	400	5
Cockpit:		3
Armor Factor:	120	7.5
	<i>Armor Value</i>	
Nose	40	
Wings	30/30	
Aft	20	

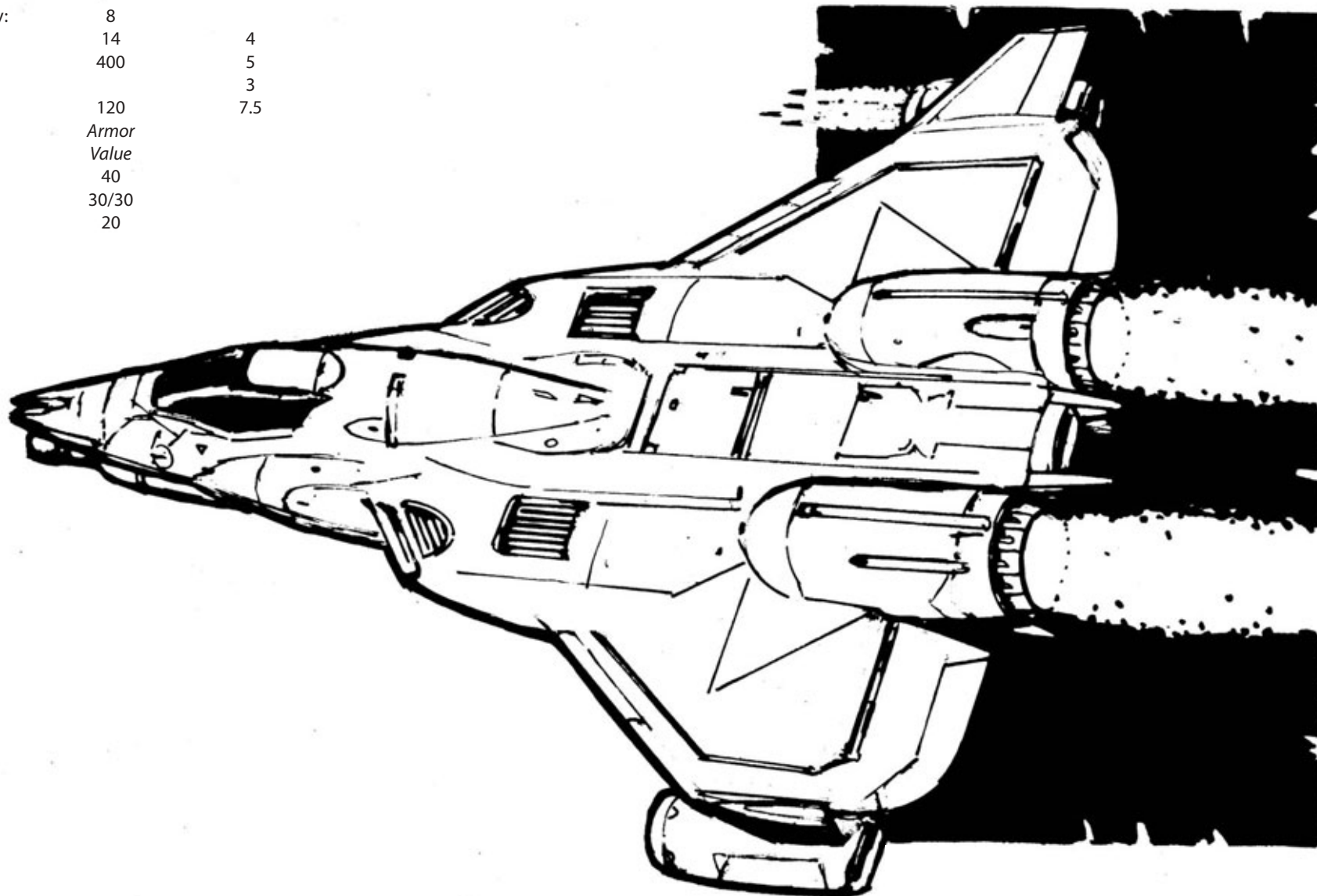

[EDITOR'S NOTE: Victor, with the most recent discoveries coming to light, I find that Caradoc's introduction to these Star League designs is so antiquated as to be irrelevant and erroneous. I've taken the liberty to pen the most accurate picture possible at this point. —Focht]

The discovery of a Hegemony Memory Core was not as universe-shaking as the Helm Memory Core, but its historical revelations are casting new light on the history of the Age of War and Star League.

For example, it's taken for granted today that the original Star League prompted great strides in various areas of military technology. Various weapons and construction materials had just begun to filter down to the Houses when the Succession Wars erupted. While the Star League member-state militaries and Star League Defense Force's regular regiments received designs with a smattering of these new technologies, the Clans' historical databases were the first hint that the Royal regiments' BattleMechs were more extensively equipped with advanced technology than anyone thought. Almost all of these updated models departed with Kerensky, leaving only a handful behind. That led ComStar to believe that these more advanced units had not been more than limited runs. Even the stockpiles of SLDF hardware on Terra, which formed the basis for the Com Guards, were castoffs not built to Royal regiment specifications. Many believed that the common SLDF designs left in the Inner Sphere were the pinnacle of the technology, and ComStar erroneously codified these designs in *Technical Readout: 2750*.

Thanks to the devastation of the Succession Wars, the Inner Sphere would not reach a similar level of technology for centuries. System after system was devastated, destroying valuable plants and databases, and killing those who would have been able to restore the past. With the technological infrastructure and know-how lost, many concessions and compromises were required to keep even the remaining Star League designs alive or, more rarely, in production.

Many denizens of the 31st Century who encountered these jury-rigged survivors of the Star League believed they were special, sometimes one-of-a-kind machines. It was not until the War of 3039 that these designs' original models—or, at least, the models that the Star League made available to the member-state militaries—made a re-appearance in large quantities with the formation of the Combine's Ghost Regiments and the revelation of the Com Guards.

Of course, it is now understood why our parents and grandparents might mistake a creaking SLDF *Lancelot* downgraded to LNC25-02 standards to be a special machine. Careful study of the records unveiled by Wolfnet in the 3050s uncovered numerous errors, discrepancies, and well-orchestrated campaigns to hide many of those once-advanced designs. Not only were experts prevented from studying and duplicating the designs effectively as the Houses and ComStar tried to prevent their foes from recovering advanced technology, but they also were kept from maximizing the advantage of the recovered Star League designs against would-be adversaries blinded by misinformation.

Not all disappearances of Star League-era designs were due to ComStar misinformation and anti-technology operations. Designs such as the *Mercury*, *Exterminator*, and the *Crockett* did not survive the Succession Wars, despite various efforts to restart production using inferior equipment. For example, Kallon Industries, attempting to start production of the *Exterminator* in 3007 to replace its popular *Wolverine*, found a complete lack of interest in the "dumbed-down" *Exterminator*, which was even less capable than the *Wolverine* it was attempting to replace. Only twenty-five of these downgraded models were produced, none of which survived the Fourth Succession War. The *Mercury* and the *Crockett* died honorably on the fields of battle, with the last machine to fall looking vastly different than the original 'Mechs due to the various jury-rigged, low-tech replacement parts used to keep them running over the centuries.

And then someone (I'm not at liberty to say who—or where it was originally found—as part of the deal for acquiring a copy of the Memory Core...but everyone will know all too soon) started poking around in the wastelands of an ex-Hegemony world and put a new twist on the accepted historical accounts. I'm not sure why this person zeroed in on that bunker, but if they were looking for a cache of the Star League Defense Force's finest Royal regiment BattleMechs, they didn't find them—they should've been looking for those in the glassy craters that dot the world's surface, where the planetary militia made its last stand against the encroaching Houses. Wealthy Hegemony (or, more accurately, ex-Hegemony) planets had the finest gear, of course, and so a House military often had to resort to nuclear weapons when target planets were so unreasonable as to not join the House, or what's worse, sided with another House. But the militia records in that bunker detailed the make and model of units fielded, along with info on units they were desperately buying from the surviving and rebuilt Hegemony military factories, and those machines were not so ... limited ... as those ComStar portrayed in *Technical Readout: 2750*.

This person did find 'Mechs in the bunker, though, ghosts of a time when it took a prestigious, powerful world to rate any BattleMechs at all. At some point over three hundred years prior to its demise, the planet had taken the trouble to mothball those 'Mechs, apparently considering even newly obsolete 'Mechs worth keeping.

The story of the original Star League's Royal units and their great ancestors is not one for this publication. They only provide a newly clarified framework to see where the topics of this chapter fit into the story of the BattleMechs of the original Star League.

Here, to set the record straight, is the correct (to the best of our knowledge) information on the low-tech versions of Star League Defense Force BattleMechs used during the Succession Wars. The most common configurations that existed prior to the appearance of the Com Guards are presented. Because of their extinction prior to the 3039 era, I have made the deliberate decision not to include the *Mercury*, *Exterminator*, and *Crockett* within these files so as to illustrate the proper look and feel of the time.

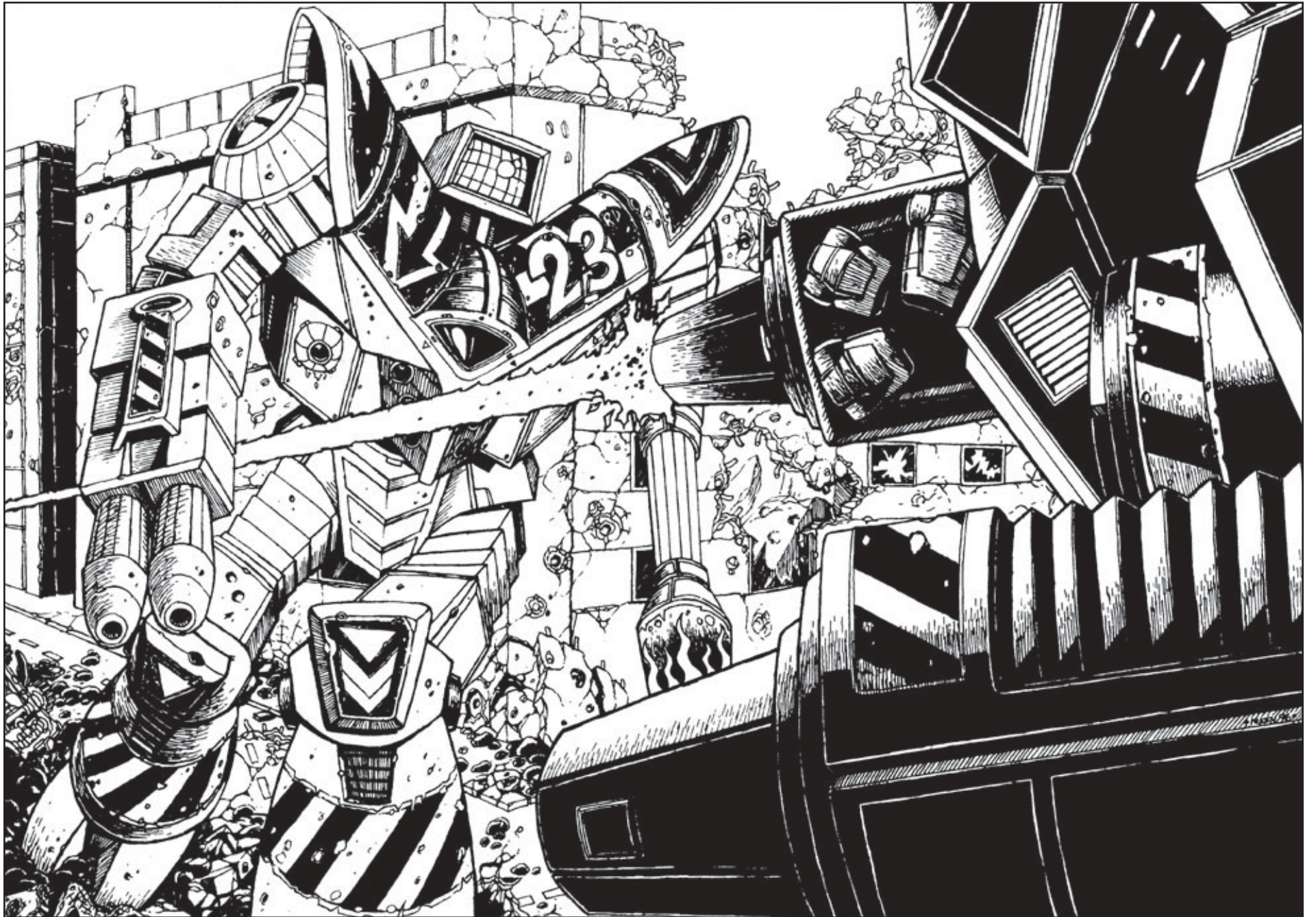

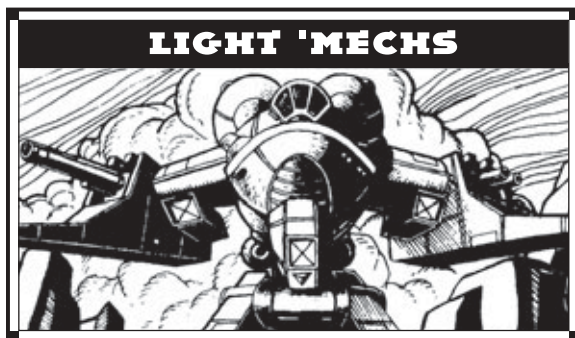

Mass: 20 tons

Chassis: Chariot Type II

Power Plant: GM 120

Cruising Speed: 64 kph

Maximum Speed: 97 kph

Jump Jets: None

Jump Capacity: None

Armor: Durallex

Armament:

1 Zeus-5 LRM Launcher

2 Hellion Spitfire Medium Lasers

Manufacturer: Ford Military Limited (ComStar Refit)

Primary Factory: Terra

Communications System: Olmstead 30

Targeting and Tracking System: Omicron VII

Overview

The first version of the *Thorn* was unveiled in 2490, but the THE-F faced stiff competition from the LCT-1V *Locust* produced by Bergan Industries. It was only when Ford updated the design with the latest technology to create the THE-N that the Hegemony Armed Forces became interested in the *Thorn*.

Dependence on advanced technology would prove to be a fatal flaw for the *Thorn*. The devastating Succession Wars made it impossible for the Great Houses to manufacture or maintain the equipment they inherited from the fall of the Star League. Only in the ranks of the secret Com Guards did the *Thorn* remain operational.

In the thirty-first century the *Thorn* unexpectedly reappeared in the service of House Kurita. Primus Myndo Waterly was intent on countering the power of the united Federated Suns and Lyran Commonwealth. To this

end she worked to encourage the formation of the Free Rasalhague Republic to act as a bulwark between the Lyran Commonwealth and the Draconis Combine, and to strengthen the Draconis Combine for the inevitable confrontation with the embryonic Federated Commonwealth. The Primus supplied House Kurita with equipment from the vast stores of weapons that ComStar had kept hidden on Terra down through the Succession Wars. However, ComStar was not just going to hand over state-of-the-art Terran Hegemony technology. The equipment was stripped of all advanced components and refitted with modern equivalents. Officially the reason was because the DCMS lacked the resources and knowledge to maintain the equipment.

When refitting the *Thorn*, ComStar returned to the ancient THE-F blueprints to create the THE-S *Thorn* to be fielded by the Draconis Combine.

Capabilities

The *Thorn* was intended originally to be a scout 'Mech, but it faced too much competition from faster or more maneuverable units. It found a niche finally as an infantry-support 'Mech, but it also proved successful in the role of a scout hunter.

The THE-S *Thorn* has been stripped of its advanced Endo-Steel internal structure and Cellular Ammunition Storage Equipment. Requiring as it did the replacement of the BattleMech's entire skeleton—an operation that involved complete disassembly and reassembly—this operation highlights the ends to which ComStar was willing to go to prevent the leak of advanced technology. This process was facilitated by the way the *Thorn* was designed to simplify maintenance. Technicians can actually climb into the 'Mech's arms and legs to work on repairs from the inside. Unfortunately, the replacement internal structure is twice as heavy, necessitating the removal of half a ton of armor.

Another change was the replacement of the Opus I Ultrabeam communications system with a more primitive Olmstead 30 unit. ComStar certainly didn't want to give any of the Great Houses the ability to eavesdrop on the Com Guards. The Omicron VII targeting and tracking suite is another substitution, but in this case the replacement is comparable to the Orion 80 system that it replaces.

The placement of one of the Hellion Spitfire medium lasers directly under the cockpit can make battle a hot

experience for the MechWarrior. The Zeus long-range missile system is accurate but easily damaged in hand-to-hand combat. In such circumstances the missile-feed system can fail, causing missiles to become lodged in the upper arm. Subsequent damage can detonate the ammunition, destroying the *Thorn*.

Deployment

The Draconis Combine used ComStar's "gifts" to rebuild units shattered by the Lyran juggernaut during the Fourth Succession War. In addition, Theodore Kurita, serving as *Gunji-no-Kanrei* (Deputy of Military Affairs), secretly created new units with which to surprise the Combine's enemies.

Variants

The original THE-F *Thorn* is essentially identical to ComStar's downgraded THE-S. No examples of this design remain in use, but occasionally an arm or leg can be found grafted onto some veteran of the Succession Wars.

House Kurita modified some of the *Thorns* supplied by ComStar, replacing the LRM launcher with an SRM 4 to provide more firepower at short range. With the faster and more mobile *Jenner* already available, the THE-T remains both unpopular and uncommon.

Notable MechWarriors

Busosenshi Duncan Goodhughs: A survivor of the Ryuken's death duel with Wolf's Dragoons on Misery before the Fourth Succession War, Duncan was amongst the cadre of troops Theodore Kurita used to spread his new doctrine throughout the DCMS. When the Ryuken was reformed, Duncan was assigned to his old regiment, the Ryuken-go.

On Khosa VII, Duncan and his *Thorn*, "*Aiguchi*," dueled with the LRM equipped *Locusts* of the Second New Ivaarsen Chasseurs.

THE-S THORN

Type: **Thorn**

Technology Base: Inner Sphere

Tonnage: 20

Battle Value: 510

Equipment

		Mass
Internal Structure:		2
Engine:	120	4
Walking MP:	6	
Running MP:	9	
Jumping MP:	0	
Heat Sinks:	10	0
Gyro:		2
Cockpit:		3
Armor Factor:	64	4

	<i>Internal Structure</i>	<i>Armor Value</i>
Head	3	8
Center Torso	6	8
Center Torso (rear)		4
R/L Torso	5	6
R/L Torso (rear)		3
R/L Arm	3	6
R/L Leg	4	7

Weapons and Ammo

	Location	Critical	Tonnage
LRM 5	RA	1	2
Ammo (LRM) 24	RT	1	1
Medium Laser	H	1	1
Medium Laser	LA	1	1

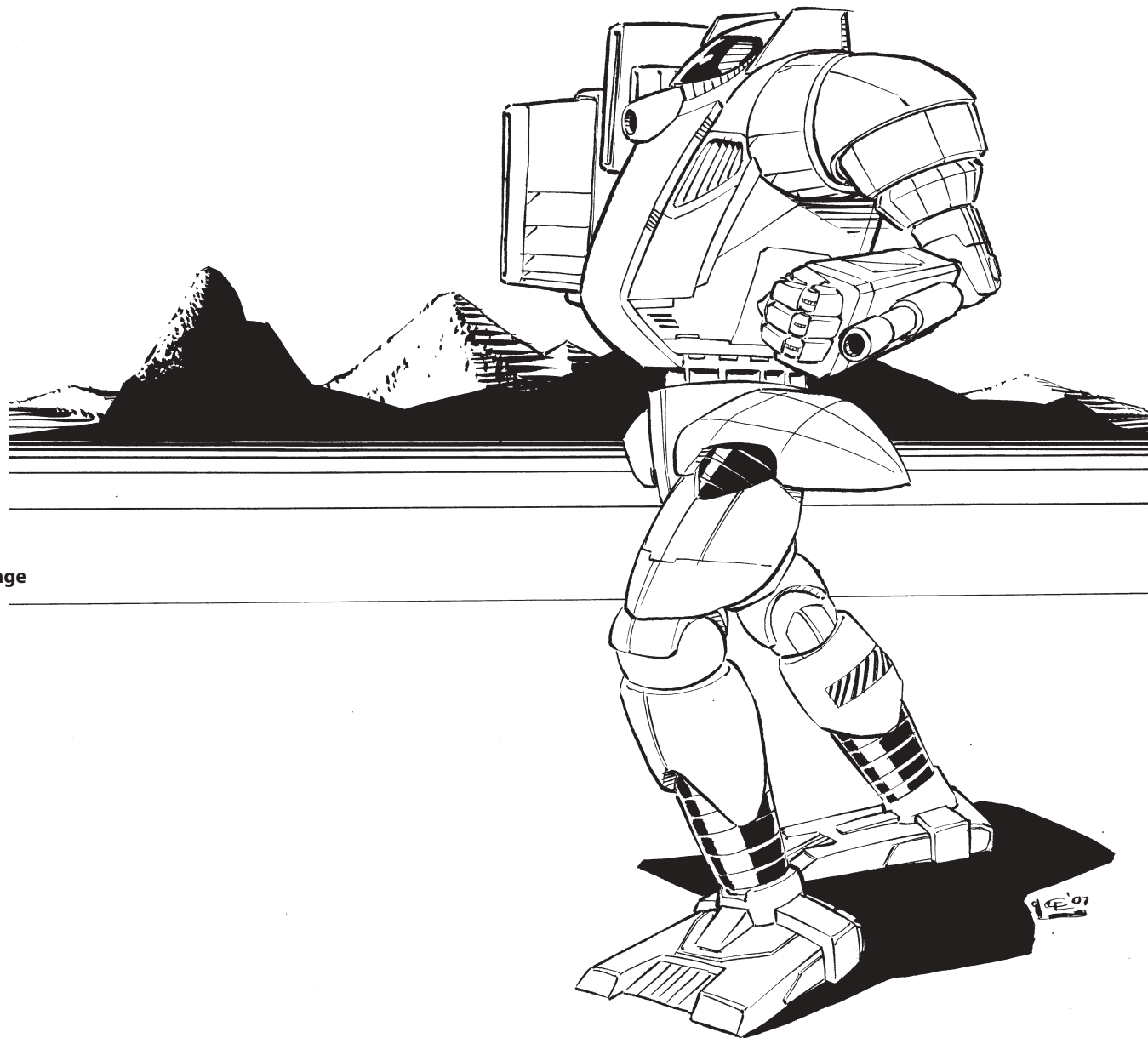

1E'07

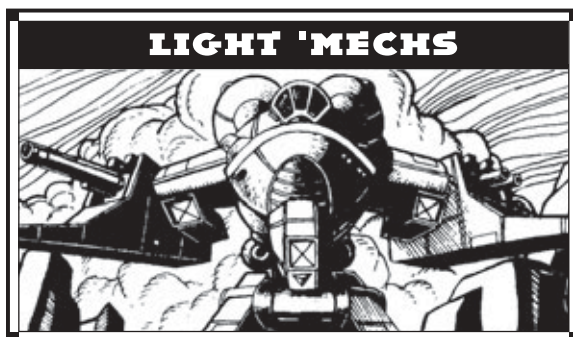

Mass: 20 tons

Chassis: Earthwerk Trooper

Power Plant: GM 120

Cruising Speed: 64 kph

Maximum Speed: 97 kph

Jump Jets: None

Jump Capacity: None

Armor: Livingston Ceramics

Armament:

1 Martell Large Laser

1 Olympian Flamer

2 Martell Small Lasers

Manufacturer: Earthwerks Incorporated

Primary Factory: Asuncion, Bernardo

Communications System: Neil 2000

Targeting and Tracking System: Dalban HiRez-B

Overview

The Free Worlds League wanted a light unit to scout for its new BattleMech force. The prototypes of the *Trooper* hit the test fields in 2475. The design was filled with so many flaws, however, that it didn't pass a field combat test until the twenty-sixth century. Rather than assign soldiers to a design with over twenty-five years of bad press associated with its name, the FWL renamed it the *Flea*. During the early Succession Wars, the inexpensive *Flea* was easy to mass-produce, but losses were too great for the Great Houses to tolerate and the line was switched to produce heavier designs until the arrival of Wolf's Dragoons.

Capabilities

The *Flea's* design is focused on speed and firepower. At just under 100 kph, it could keep up with most scout units of the late Succession Wars, and the Martell large laser can outrange most of their weapons. For close combat, the *Flea* also has a pair of small lasers, and a rear-mounted flamer can be useful for setting fires. Its placement, however, has led to more than one derisive comment.

If the weaponry of the *Flea* isn't enough to scare the opposition, the *Flea's* pilot can use its speed to avoid being hit. With a meager two tons of armor (half that of the *Locust*), there is little room for error. A mere medium laser can punch through most of its armor, and a large laser will easily shear off a limb.

Deployment

Outside of the Free Worlds League, the *Flea* virtually vanished until the Dragoons appeared with a half-dozen of the design. Earthwerks reopened the *Flea* line to provide parts and occasionally new 'Mechs for the Dragoons under an exclusive contract. After the devastation of the Fourth Succession War, the Dragoons were down to a pair of *Fleas* and ordered many more to help rebuild their battered regiments. Earthwerks opened two new *Flea* lines on Asuncion and Bernardo to keep up with the demand.

A demonstration of the *Flea's* abilities occurred slightly before the birth of the Star League in the waning days of the Age of War. In the late twenty-sixth century, a pair of Third Marik Militia *Fleas* were covering a pair of *Hunchbacks*. A trio of *Commandos* managed to maneuver behind the *Hunchbacks*, and so intent were they on getting a shot at the large 'Mechs' vulnerable rears, the Steiner pilots ignored the lighter *Fleas*. While one *Hunchback* exploded after the first salvo from the *Commandos*, one of their own went down with a missing leg from the combined fire from the *Fleas*. The two remaining *Commandos* couldn't outrun the *Fleas*, but their mobility was adequate to avoid the *Hunchback's* cannon. By using the *Hunchback* to herd the *Commandos*, the *Fleas* predicted the Lyran 'Mechs' moves and eventually cut them down.

Variants

Until the 3040s, the only significant variant was the FLE-15. This drops the large laser for a ton more armor and increased weaponry. The arm lasers are moved to cover the rear, while the flamer is moved to the front of the 'Mech. The arms carry a machine gun and medium laser each, while a full ton of ammo allows plenty of endurance for the *Flea*.

Notable MechWarriors

MechWarrior Roy Roehmer: A member of Wolf's Dragoons' Special Recon Group, Roy doesn't see a lot of combat and that is the way he likes it. Piloting a *Flea-15*, he uses the flamer and machine guns far more than his lasers, creating disruption in the enemy's rear. However, Roy's ability to sneak around with a 20-ton machine allows his fellow warriors to know where the enemy is. As the Dragoons have rebuilt themselves after the Fourth Succession War, the SRG has been attached to the Home Guard, but Roy is itching to return to the field. This has led to him practicing with mercenary units on Outreach whenever possible and celebrating with them far too much.

MechWarrior Phoenix Marik-Steiner: If Phoenix is to be believed, which few do, he is the progeny of an alleged tryst between Janos Marik and Katrina Steiner that occurred in 3001. Everything with him is epic, from his hour-long battle with a *Stinger* that was the key 'Mech in a company about to single-handedly destroy Hassad to fighting off what appeared to be the flu but supposedly was the Miaplacidus Plague. The Second Marik Militia would just as soon be rid of him if he weren't a halfway decent scout, and the Second needs every good pilot they can get.

Type: **Flea**

Technology Base: Inner Sphere

Tonnage: 20

Battle Value: 427

Equipment

Internal Structure:

Engine: 120

Walking MP: 6

Running MP: 9

Jumping MP: 0

Heat Sinks: 10

Gyro:

Cockpit:

Armor Factor: 32

Mass

2

4

0

2

3

2

	Internal Structure	Armor Value
--	--------------------	-------------

Head	3	5
------	---	---

Center Torso	6	5
--------------	---	---

Center Torso (rear)		2
---------------------	--	---

R/L Torso	5	3
-----------	---	---

R/L Torso (rear)		1
------------------	--	---

R/L Arm	3	3
---------	---	---

R/L Leg	4	3
---------	---	---

Weapons

and Ammo

	Location	Critical	Tonnage
Large Laser	RA	2	5
2 Small Lasers	LA	2	1
Flamer	CT (R)	1	1



1E'07

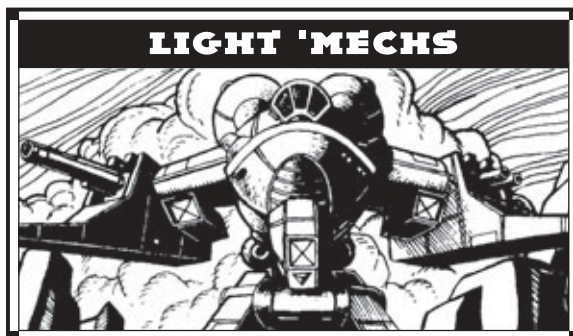

Mass: 20 tons
Chassis: Fischer HNT
Power Plant: Hermes 100
Cruising Speed: 54 kph
Maximum Speed: 86 kph
Jump Jets: Pitban LFT-50
Jump Capacity: 150 meters
Armor: Bulletban-80
Armament:
 1 Holly LRM 5
 1 Martell Medium Laser
 1 Martell Small Laser
Manufacturer: Kallon Weapon Industries
Primary Factory: Talon
Communications System: Tri-Word Duplex 4880
Targeting and Tracking System: Dalban HiRez II

Overview

Little interest was shown in the *Hornet* when it debuted in 2760. The Star League era spawned a host of highly specialized designs, for the Star League Defense Force was large enough (and rich enough) to utilize them. Nevertheless, the *Hornet*—intended for the niche role of urban reconnaissance—was soundly rejected, and Kallon Industries discontinued production after only two years.

As the Succession Wars dragged on, BattleMechs of any kind became highly prized items. The neatly regimented ranks of the Star League-era armies became fragmented, and equipment previously envisaged for training, support, or reconnaissance roles was pressed into service on

the front lines. Thus when Kallon Industries rediscovered the blueprints for the long-forgotten *Hornet* in the closing years of the Third Succession War, they rushed it back into production in 2990. At first success again eluded the *Hornet*. House Davion was satisfied with tried and tested designs such as the *Valkyrie*, resulting in few sales to the AFFS. Only mercenary commands and planetary militias showed much interest.

It was Wolf's Dragoons who demonstrated the *Hornet* to best advantage during their bloody feud with House Kurita. After-action reports from the fighting on Misery, Glenmora, and Crossing finally convinced the Federated Suns that the HNT-151 had a valuable role to play.

Capabilities

The *Hornet* is lightly armed but well armored for a BattleMech of its size. Although slower than the average light 'Mech, this is offset somewhat by the Pitban LFT-50 jump jets. In addition, few other light 'Mechs carry LRM launchers. While lacking punch, the Holly missile rack allows the *Hornet* to deal out damage to fleeting light units or sting heavier units before falling back. Thus the *Hornet* is often found operating as a scout hunter or providing fire support.

If the *Hornet* has a weakness, it is its stubby arms. Lacking hand and lower-arm actuators, the 'Mech fares poorly in close combat.

Deployment

Mercenary commands continue to use the *Hornet*, and Wolf's Dragoons used the 'Mech in their reconstruction efforts following the Fourth Succession War. The AFFS has now taken an interest in the *Hornet*, using it extensively in the Draconis, Crucis, and Capellan March Militias. The design has also started to find its way into the ranks of the Avalon Hussars and Crucis Lancers.

A battalion from Kurita's Eighth Sword of Light raided the Davion world of Tishomingo in 3034, which was the site of several manufacturers of agricultural machinery. Disruption of shipments would raise the specter of starvation over the worlds of the Draconis March.

A skillful combat drop caught the Dahar March Militia flat-footed, and all that stood between the Sword of Light

and their objective was a company of *Hornets* and *Valkyries* guarding a raised causeway that led to warehouses full of farm equipment waiting to be shipped. As the *Dragons* and *Panthers* of the lead company thundered down the causeway, they ran into a hail of LRMs. Combine BattleMechs took cover and waited for the next salvo. But it never came. After a few tense minutes the Kuritan company scrambled back up onto the causeway and resumed their advance, only to be hit by another wave of LRMs.

These sniping attacks continued, slowing the Combine attack force long enough for Militia *Javelins* and *Blackjacks* to set up an ambush further down the causeway. The combined LRM and SRM fire decimated the attackers.

Variants

Never manufactured as a production model, the HNT-152 is a common field modification. It replaces the Holly LRM system with a Holly SRM 4 launcher.

Notable MechWarriors

MechWarrior Robert Grey: Solitary and moody away from his 'Mech, Robert Grey is a hunter who comes alive in battle. Spending long hours stalking other 'Mechs, Grey revels in outwitting and outmaneuvering heavier units. A member of the elite McKinnon's Raiders (also known as the Fox's Teeth), Grey received his *Hornet* as a reward for his actions on Tikonov during the Fourth Succession War.

Lieutenant Genevieve Katulass : Lieutenant Katulass doesn't fit the typical MechWarrior profile. A botanist of some fame, there is little need for Katulass to risk her life on the battlefield. However, serving in a mercenary command (in this case, the Killer Bees) presents opportunities to visit more worlds than would ever be possible for a mere civilian scientist.

Commanding a light BattleMech lance, Katulass' MechWarriors are well trained in providing fire support. Raiding Kurita worlds in the Alshain Military District in 3039, the lance deterred DCMS scout hunters from continuing pursuit on several occasions.

HNT-151 HORNET

Type: **Hornet**

Technology Base: Inner Sphere

Tonnage: 20

Battle Value: 488

Equipment

Internal Structure:

Engine: 100

Walking MP: 5

Running MP: 8

Jumping MP: 5

Heat Sinks: 10

Gyro:

Cockpit:

Armor Factor: 64

Internal Structure	Armor Value
--------------------	-------------

Head	3	8
------	---	---

Center Torso	6	8
--------------	---	---

Center Torso (rear)		4
---------------------	--	---

R/L Torso	5	8
-----------	---	---

R/L Torso (rear)		2
------------------	--	---

R/L Arm	3	6
---------	---	---

R/L Leg	4	6
---------	---	---

Mass

2

3

0

1

3

4

Weapons

and Ammo

Location	Critical	Tonnage
----------	----------	---------

LRM 5	RT	1	2
-------	----	---	---

Ammo (LRM) 24	LT	1	1
---------------	----	---	---

Medium Laser	RA	1	1
--------------	----	---	---

Small Laser	LA	1	.5
-------------	----	---	----

Jump Jets	RL	2	1
-----------	----	---	---

Jump Jet	CT	1	.5
----------	----	---	----

Jump Jets	LL	2	1
-----------	----	---	---

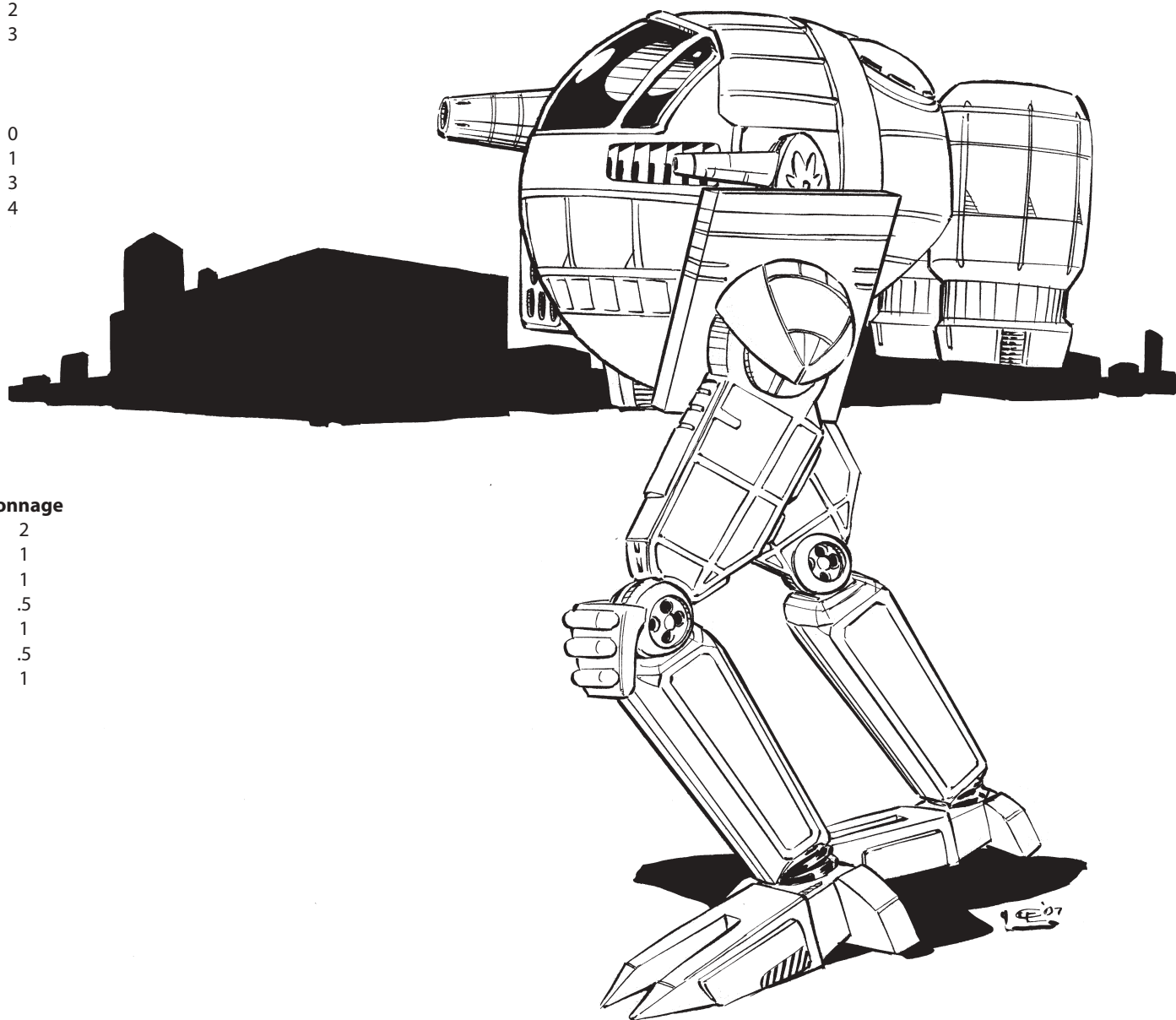

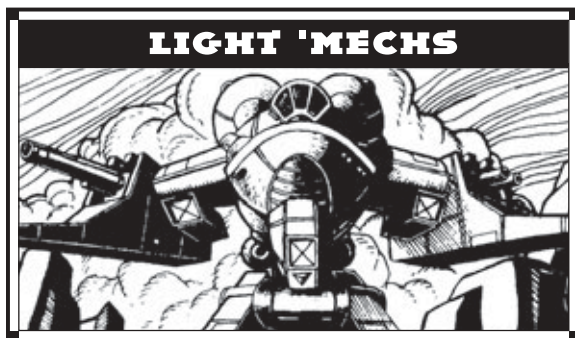

Mass: 25 tons

Chassis: Kell/D Standard

Power Plant: Nissan 200

Cruising Speed: 86 kph

Maximum Speed: 129 kph

Jump Jets: None

Jump Capacity: None

Armor: ProtecTech 6

Armament:

3 Starflash Medium Lasers

1 Starflash Small Laser

Manufacturer: Diplan 'Mechyards

Primary Factory: Ozawa (destroyed 2837)

Communications System: ON-5

Targeting and Tracking System: TharHes Mars-1

Overview

Upon its introduction in the spring of 2660, the swift and agile *Mongoose* quickly became popular with light lance commanders in the Star League Defense Force. Its maneuverability combined with its outstanding Beagle Active Probe made the MON-66 superior to every other scout 'Mech on the field, while its advanced electronics made it very suitable as a command 'Mech for a whole light company. It took only eight years before the *Mongoose* was considered the standard command 'Mech for all light and recon lances.

The Succession Wars took a heavy toll on the number of *Mongoose*s. Its status as the epitome of scout BattleMechs ensured that it was a top priority for destruction. Compounded by the loss of technology that provided the MON-66 with its advanced armor, internal structure,

and its trademark Beagle Active Probe, the *Mongoose* became a rare sight on the battlefield even before the Second Succession War was over.

Capabilities

Intended to eventually replace the ubiquitous *Locust*, the *Mongoose* is better armed and armored. While not as efficient at anti-infantry combat as the *Locust*, the MON's Beagle Active Probe expanded its scouting capabilities well beyond that of the *Locust*. Further, its ability to withstand or defeat hostile BattleMechs gives the *Mongoose* the option to force itself into places another scout 'Mech would avoid.

None of the 'Mechs operational before the War of 3039 have a functioning Beagle Active Probe, nor do any still possess ferro-fibrous armor or endo-steel internal structure. This downgraded version, categorized as the MON-67, is still an extremely competent scout 'Mech, although outperformed by 'Mechs with jump jets in broken terrain. Some owners of the *Mongoose* have attempted to expand the 'Mech's abilities by adding more weaponry, so that it can blast its way into more interesting areas to scout. While many agree that this approach makes sense, it is not possible with current day technologies to accomplish this task effectively.

One drawback of the *Mongoose* is its limited heat dissipation ability, a problem that the old model had as well. While not as debilitating and acute as the heat load issues on other BattleMechs, the *Mongoose* nonetheless will see its performance severely impaired if it uses its entire arsenal without pause during combat. Compounding this issue are problems with the cooling jacket of the medium laser mounted in the center torso. Placed in almost direct contact with the Nissan 200 fusion engine, the jacket quickly deteriorates, sometimes after only one hundred discharges of the laser. Once deteriorated, the laser's heat accumulates without dissipating, exacerbating the 'Mech's heat issues. Though the cooling jacket is relatively easy to replace, the failure can become a prominent issue during extended campaigns. MechWarriors aware of this issue compensate to a degree by not utilizing the torso mount as often as the arm-mounted lasers.

Despite the heat issues, the centre torso and head-mounted lasers are extremely precise thanks to special internal compensators. These allow the *Mongoose* to be pinpoint accurate even when at a full run.

Deployment

Because of their widespread use by the Star League Defense Force, the rare *Mongoose*s that remain in service are spread roughly equally among the Successor States. Due to their ownership of Ozawa since the Second Succession War, which has provided some spare parts for the *Mongoose* over the years, House Davion has the greatest proportion of this venerable BattleMech outside the ranks of ComStar.

Variants

A recent modification by the DCMS is becoming popular within the ranks of House Kurita. After swapping out the Nissan 200 for a GM 175, all the traditional weaponry is stripped in order to mount a single Diverse Optics Type 30 large laser in the right arm. The 200-rated engines are used as replacements on certain 50-ton 'Mechs. Still swift enough to snipe at slower enemies that it can't face directly, the MON-68 is receiving high marks from Kuritan raiders.

Notable MechWarriors

Chu-i Terrence McNamara: Commanding a company of light strike 'Mechs in the Second Night Stalkers, *Chu-i McNamara* has requested the MON-68 upgrade for his ancient *Mongoose*. The 'Mech, "*Exorciser*", became a part of the DCMS when Terrence's ancestor left the Star League Defense Force, and it has served House Kurita loyally for more than 250 years.

MON-67 MONGOOSE

LIGHT 'MECHS

247

Type: **Mongoose**

Technology Base: Inner Sphere

Tonnage: 25

Battle Value: 741

Equipment

Internal Structure:

Engine: 200

Walking MP: 8

Running MP: 12

Jumping MP: 0

Heat Sinks: 10

Gyro: 2

Cockpit: 3

Armor Factor: 88

Mass

2.5

8.5

0

2

3

5.5

*Internal
Structure* *Armor
Value*

Head 3 9

Center Torso 8 12

Center Torso (rear) 3

R/L Torso 6 10

R/L Torso (rear) 2

R/L Arm 4 8

R/L Leg 6 12

Weapons

and Ammo

Location **Critical** **Tonnage**

Medium Laser RA 1 1

Medium Laser LA 1 1

Medium Laser CT 1 1

Small Laser H 1 .5

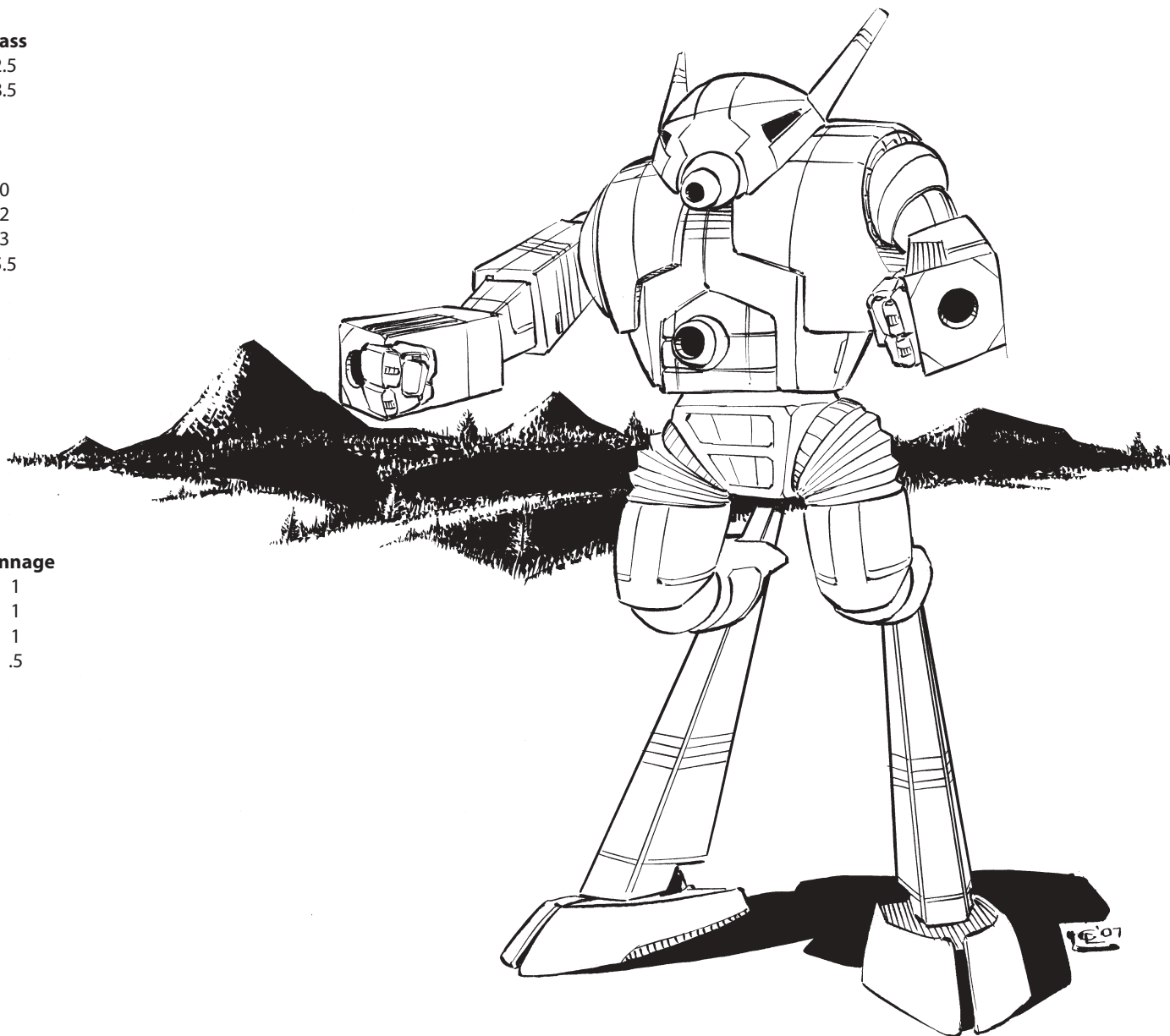

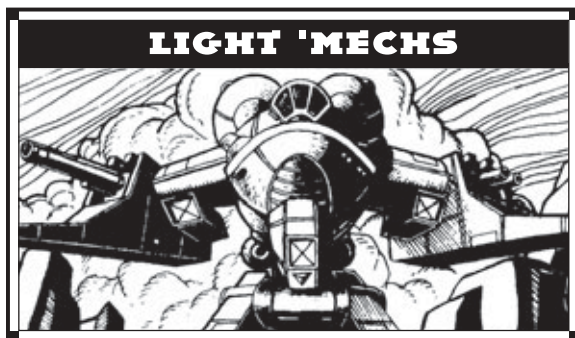

Mass: 30 tons
Chassis: Duralyte 296
Power Plant: GM 180
Cruising Speed: 64 kph
Maximum Speed: 97 kph
Jump Jets: PRS-60
Jump Capacity: 180 meters
Armor: StarGuard Type II
Armament:
 1 SunGlow Type 1 Medium Laser
 2 Omicron 1000 Light Lasers
 2 Reginald Mark VI Machine Guns
Manufacturer: Stormvanger Assemblies, Light Division
Primary Factory: Hesperus II (destroyed 2789)
Communications System: Garret T20C
Targeting and Tracking System: Dynatec 150A

Overview

The outbreak of the Reunification War left member states of the newly formed Star League fighting a conflict for which they were ill-prepared. True, the Great Houses possessed sizable armies. But they were equipped to fight each other using the tactics and strategies evolved during the Age of War—not to fight at the end of an extended line of supply against guerrilla forces out in the Periphery. The House troops deployed to support the newly created Star League Defense Force needed suitable weapons, and fast.

A flood of new designs emerged to meet the demand for weapons to fight the “barbarians who dared to threaten the unity of mankind.” One of these was

Stormvanger Assemblies’ *Falcon*. A creation of the corporation’s Light Division, the ‘Mech remained in production at Stormvanger’s Hesperus II facility in the “Falcon Wing” until a Marik raid destroyed it during the First Succession War.

Capabilities

Bigger and tougher than the more common *Stinger*, *Wasp*, and *Locust*, the *Falcon* often drew the assignment of “Bug Hunter.” While its armament is only comparable with that of lighter units, the *Falcon* boasts significantly more armor for an edge in any encounter.

Of special note are the two rear-firing machine guns. Early battles in the Periphery had demonstrated graphically that Star League BattleMechs were in as much (if not more) danger from infantry as they were from Periphery ‘Mechs and armor. The machine guns were added late in the design process to keep swarming infantry off the *Falcon*’s back.

Deployment

The new *Falcon* was commissioned into service with units such as the Fourth Royal Guards, Tamar Tigers, and Twenty-fifth Skye Rangers—members of the Lyran Expeditionary Force participating in Operation Mailed Fist. Under overall command of Archon Viola Steiner-Dinesen, the LEF supported the SLDF’s campaign against the rebel government of the Rim Worlds Republic.

In 2591 news reached the Archon that her son, Archon Designate Kevin Dinesen, had been kidnapped on Tharkad. Enraged by (false) rumors that the Dukes of Tamar and Skye were behind the abduction, the Archon led the Royal Guards against the Skye Rangers and Tamar Tigers. In what became known as the “Day of Rage,” *Falcon* fought *Falcon* until SLDF troops arrived to break up the fight.

The *Falcon* was made available to other League member states, and the design also found a home in many SLDF line regiments. However, the loss of the Stormvanger Assemblies production line on Hesperus II put an end to new production, and numbers dwindled during the course of the Succession Wars. Of course ComStar possessed a number of *Falcons* amongst its secret cache of weapons on Terra, but as far as the Inner Sphere was concerned the design had all but vanished.

The appearance of Wolf’s Dragoons in 3005 marked the return of the *Falcon* to the battlefields of the Inner Sphere. The Dragoons rebuffed all inquiries as to its origins, but their possession of lost designs like the *Falcon* sparked intense speculation. The speculation ended, of course, when the Clans invaded and the Dragoons explained their origins.

After the Fourth Succession War a number of *Falcons* appeared in the Draconis Combine. Thought to have been salvaged from the fighting between the Ryuken and Wolf’s Dragoons on Misery, these ‘Mechs had actually been secretly supplied to House Kurita by ComStar.

Variants

The *Falcons* that remain in the Inner Sphere are almost all extensively repaired, many of them becoming hybrids with arms, legs, and weapons taken from other BattleMechs. Only Wolf’s Dragoons have access to new, undamaged ‘Mechs of this type.

Notable MechWarriors

MechWarrior Maurice Frenn: Formerly a member of Gamma Regiment, Frenn was wounded twice during the brutal fighting that almost destroyed Wolf’s Dragoons in the Fourth Succession War. One of the only MechWarriors of Wisey’s Company to survive the bloodbath at Fort Belvoir on Harrow’s Sun, Frenn was recruited along with a handful of Gamma survivors by the legendary Natasha Kerensky when she formed the Black Widow Battalion.

Frenn’s specialty is setting up ambushes—a skill that the Black Widow has utilized on numerous occasions. Of course this ability has given Frenn a special appreciation of how to read terrain, and he is equally adept at spotting an enemy ambush.

Chu-i Hiro Yoshigi: Of one-quarter Scandinavian extraction, Hiro Yoshigi has battled prejudice throughout his career. Assigned to the (now defunct) Rasalhague Regulars, it is a testament to both Hiro’s skill and loyalty that he has secured a transfer to command a recon lance in the prestigious Genyosha.

FLC-4N FALCON

Type: **Falcon**

Technology Base: Inner Sphere

Tonnage: 30

Battle Value: 610

Equipment

		Mass
Internal Structure:		3
Engine:	180	7
Walking MP:	6	
Running MP:	9	
Jumping MP:	6	
Heat Sinks:	12	2
Gyro:		2
Cockpit:		3
Armor Factor:	96	6

	Internal Structure	Armor Value
Head	3	9
Center Torso	10	14
Center Torso (rear)		3
R/L Torso	7	12
R/L Torso (rear)		2
R/L Arm	5	8
R/L Leg	7	13

Weapons

and Ammo	Location	Critical	Tonnage
Medium Laser	RA	1	1
Small Laser	RA	1	.5
Small Laser	LA	1	.5
Machine Gun	RT (R)	1	.5
Machine Gun	LT (R)	1	.5
Ammo (MG) 200	CT	1	1
Jump Jets	RT	3	1.5
Jump Jets	LT	3	1.5

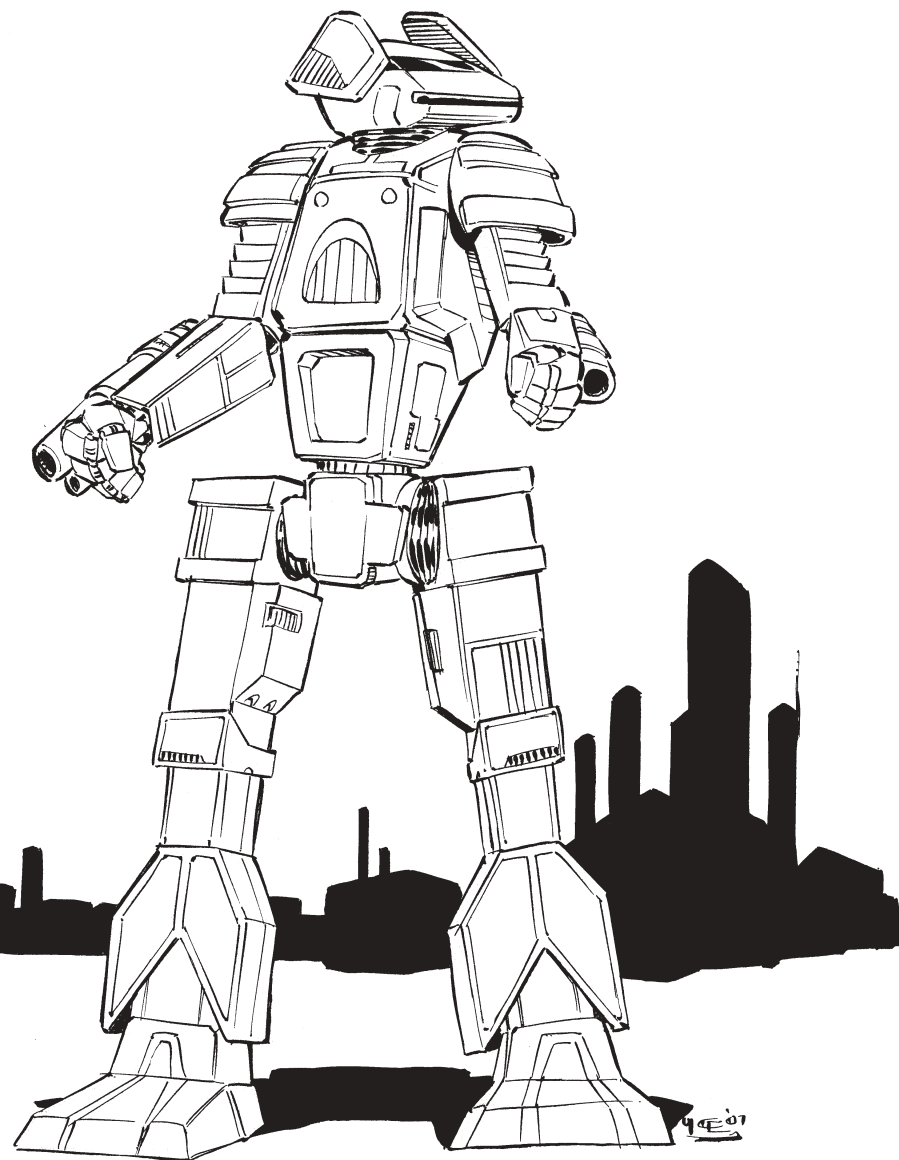

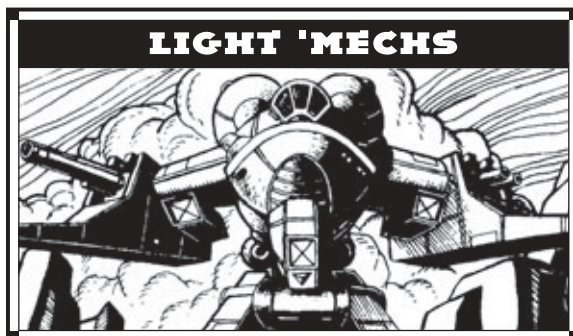

Mass: 30 tons
Chassis: Irian Chassis Class 10 Standard
Power Plant: GM 270
Cruising Speed: 97 kph
Maximum Speed: 151 kph
Jump Jets: None
Jump Capacity: None
Armor: Starshield
Armament:
2 Hellion-V Medium Lasers
1 Olympian Flamer
Manufacturer: Irian BattleMechs Unlimited
Primary Factory: None (refits only)
Communications System: Irian TelStar
Targeting and Tracking System: Wasat Aggressor

Overview

Commissioned for the Star League Defense Force in 2632, the *Hermes* was rushed through design and production and entered regular service with a number of glitches and design flaws. Several years of repair and redesign ensued before the *Hermes* began to perform as designed, but by that point several flaws in the basic design had become clear, and these problems made the *Hermes* unpopular in the roles for which it had been procured. The *Hermes* was in production for only nineteen years before the design was canceled and the 'Mech taken out of general SLDF service. It was only the hardship of the Succession Wars that brought the 'Mech out of the militia units to which it had been relegated and brought the production facility back online to manufacture an upgraded *Hermes II* BattleMech.

Today the 'Mech exists as ancient machines held together with spit and ingenuity, with their advanced technology stripped away for any modern equivalent that will get the job done.

Capabilities

The design specifications of the original HER-1S *Hermes* bid called for a 'Mech capable of outpacing almost any other BattleMech on the field at the time, and in that respect Irian delivered. The *Hermes*, with its maximum speed of more than 150 kph, is faster than even the swift *Locust*. Of course, this speed was not gained without cost, in this case the massive GM 270 fusion engine that occupies almost half the *Hermes*' mass.

Lightly armored and lacking jump jets, the *Hermes* attempts to compensate for these deficiencies with firepower. Two Hellion-V medium lasers provide good striking power, while an Olympian flamer allows the *Hermes* to provide its own concealment in case of close-quarters combat.

The real star of the *Hermes* was the Alexis Photon Target Acquisition System, which used a series of computer-controls and ranging lasers to determine whether or not the *Hermes* should fire its weapons when ordered. Although it was a powerful system, the knowledge to keep it running didn't survive the Succession Wars, and it was one of the first systems cannibalized. Except for the few vintage models in the Com Guard, no known examples of the Alexis Photon are known to exist.

Deployment

In the Successor State armies, the HER-1S *Hermes* originally served as a company or battalion-level scout 'Mech. With the loss of the sophisticated technology needed to keep its electronics operating, the HER-1A *Hermes* has been relegated to more traditional recon lance roles where its speed is an asset, even without the advanced sensors.

Several pristine HER-1S *Hermes* have appeared in the Com Guard, where they serve as recon 'Mechs for HPG garrisons and reaction forces. Observations of Com Guard maneuvers indicate the *Hermes*' electronics are all Star League-standard, which would give the Com Guard a powerful edge in combat against any Successor State military.

Variants

The original HER-1S *Hermes* didn't serve long enough to have any standard variants produced, and the few HER-1A downgrades remaining on today's battlefields are so scavenged that each is almost its own unique variant. Besides having their advanced endo-steel skeletons replaced with standard materials—resulting in a loss of one and a half tons of armor to compensate—and their sophisticated electronics swapped for more readily available systems, several models of medium laser replace the Hellion-Vs, and some MechWarriors retrofit the Olympian flamer with another medium laser.

Notable MechWarriors

Lieutenant Alex Upland: Lieutenant Upland serves on the staff of Colonel Tomaso Kinchuhara, commander of the First Regular Hussars. His *Hermes* can often be found near Kinchuhara's *Orion* on the battlefield, ready to sprint off to deliver a critical message or scout a distant location. Although it is rare to find a MechWarrior serving as an aide on the battlefield, Lieutenant Upland serves this task as well inside his 'Mech as out of it. He is an adept MechWarrior, despite his near-noncombatant status, with three 'Mech kills to his credit.

Subaltern Peter Grimes: Subaltern Grimes commands the recon lance of the Concordat Commandos in the Taurian Concordat. He pilots the only *Hermes* known to exist in the Periphery, leading a lance made up of his *Hermes*, two *Spiders*, and a *Locust*. This fast lance is adept at scouting terrain across the Commandos' entire axis of advance, despite its size, because of their phenomenal speed. Subaltern Grimes, however, would like to trade his *Hermes* for a more conventional *Spider*. The novelty of the *Hermes* in the Periphery means that every bandit they encounter tries to engage him just to be the one to bring "that funny-looking thing" down.

HER-1A HERMES

Type: **Hermes**

Technology Base: Inner Sphere

Tonnage: 30

Battle Value: 601

Equipment

Internal Structure:

Engine: 270

Walking MP: 9

Running MP: 14

Jumping MP: 0

Heat Sinks: 10

Gyro: 3

Cockpit: 3

Armor Factor: 56

Mass

3

14.5

0

3

3

3.5

	Internal Structure	Armor Value
--	--------------------	-------------

Head	3	7
------	---	---

Center Torso	10	7
--------------	----	---

Center Torso (rear)		4
---------------------	--	---

R/L Torso	7	6
-----------	---	---

R/L Torso (rear)		2
------------------	--	---

R/L Arm	5	5
---------	---	---

R/L Leg	7	6
---------	---	---

Weapons

and Ammo

Location	Critical	Tonnage
----------	----------	---------

Medium Laser	RA	1	1
--------------	----	---	---

Flamer	LA	1	1
--------	----	---	---

Medium Laser	CT	1	1
--------------	----	---	---

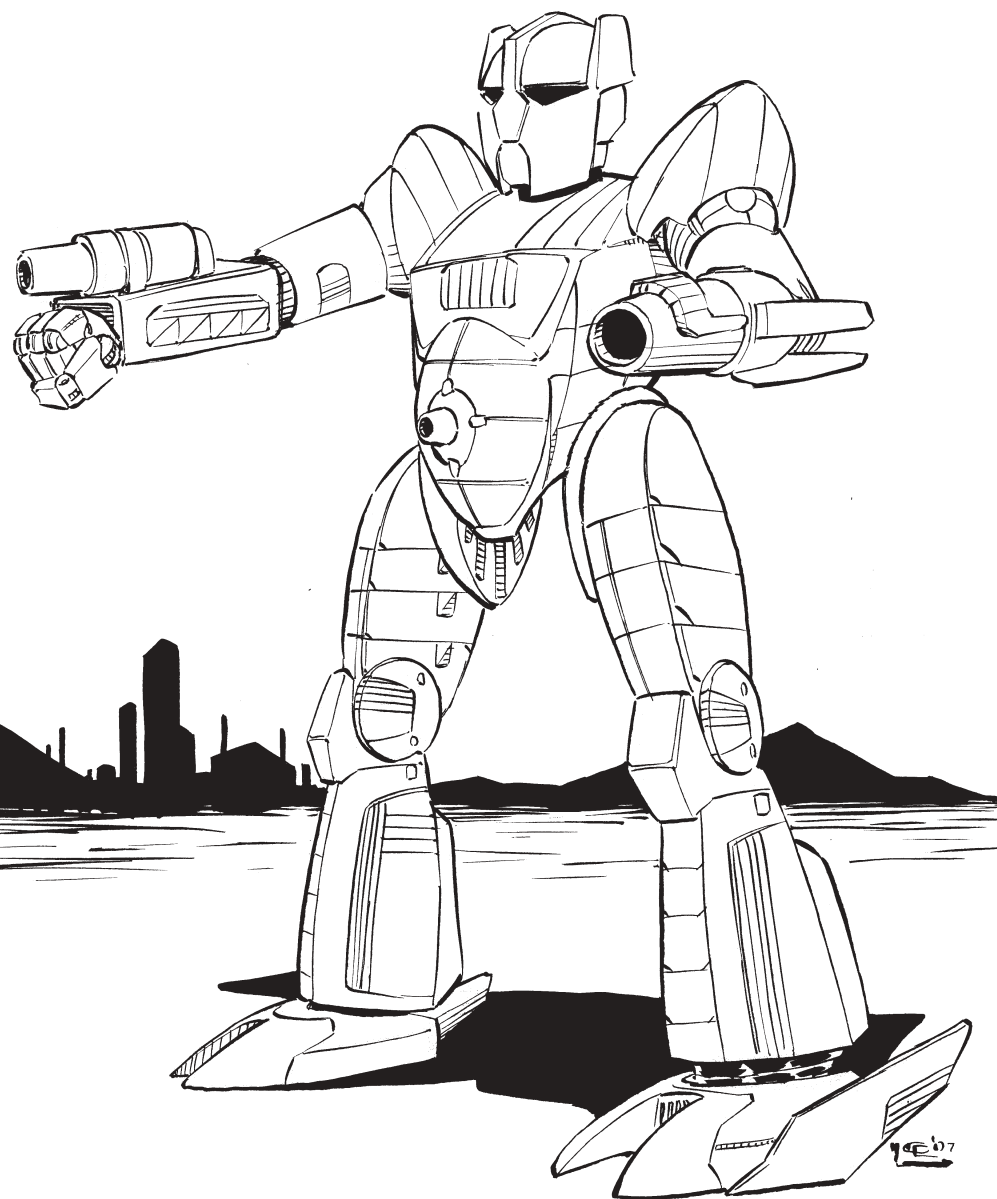

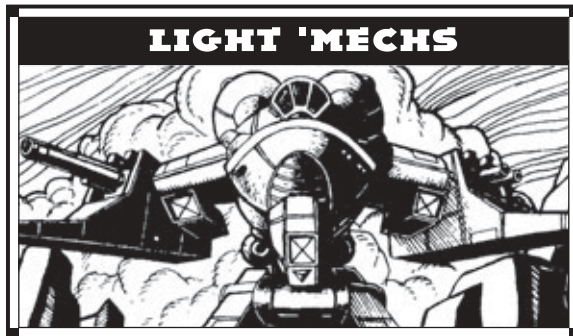

Mass: 30 tons

Chassis: Benztrov 40

Power Plant: GM 270

Cruising Speed: 97 kph

Maximum Speed: 151 kph

Jump Jets: None

Jump Capacity: None

Armor: Riese Reliable

Armament:

1 Defiance B3L Large Laser

Manufacturer: Newhart Industries

Primary Factory: New Earth (destroyed 2776)

Communications System: Garret T10B

Targeting and Tracking System: Dynatec 990

Overview

One of the most widely used light 'Mechs in the Star League Defense Force, the *Hussar* is a difficult target to hit in a one-on-one fight. Originally intended to provide fire support for infantry units, the *Hussar* proved to be even more valuable as a long-range support 'Mech when paired with *Thorns* and other nimble designs. The *Hussar* became a lostech design after General Kerensky's Exodus, which took most of the SLDF-assigned *Hussars*. The *Hussar* practically disappeared from the Inner Sphere except for those secretly hoarded by ComStar. The 'Mech returned to the battlefield during the War of 3039, after ComStar supplied the DCMS with a number of stripped units.

Capabilities

The original *Hussar*—the 200-D model—mounted an extended-range large laser, making it a favorite strike 'Mech of pilots who preferred to snipe from extreme range. Extremely nimble and very fast, a *Hussar* could operate for months (if not longer) as a guerrilla unit and was a perfect choice as a flanking and behind-the-lines harasser. It became a 'Mech of choice after the exploits of the XXX Corps of the SLDF on Wotan, where the ten *Hussars* of the "Fingers of Death" operated for three weeks behind enemy lines. With the unit's phenomenal success, many commanders sat up and took notice of the *Hussar* and its capabilities.

The only major weakness to the 'Mech is its paper-thin armor, notorious for being weak along several areas where even a simple fall could spell catastrophe. As long as the pilots didn't engage in stand-up battles and used the *Hussar's* strengths to their advantage, this weakness was minimized.

Deployment

Predominately seen among the SLDF, the *Hussar* was not as plentiful in other House militaries. Since the Star League maintained a tight lock on Newhart Industries' production lines, the only time a House managed to field one was either through battlefield salvage (an abnormal practice for the era) or by "shipping errors" (as House military intelligence agencies preferred to call the thefts). After the departure of the SLDF, the *Hussar* disappeared from nearly all TO&Es.

The *Hussar* was one of the designs provided to the Draconis Combine as a result of the secret deal brokered with ComStar in the 3030s. Though stripped of any advanced technology, the 'Mech was a potent asset, and the DCMS used them to great extent in the War of 3039. Utilizing its legendary speed, *Hussars* were able to flank slower AFFC forces and wreak havoc on their supply lines.

Variants

With so few *Hussars* remaining in the Inner Sphere, no standard variants are known to exist. The DCMS has attempted to utilize a smaller Pitban 240 engine in an effort to increase the 'Mech's armor and armaments, but with little success.

Notable MechWarriors

Colonel Stephan Cage: Commander of the 200th Dragoon Regiment of the SLDF, Colonel Cage was a genius with light-unit tactics but very short-tempered and prone to violent fits of rage in person. Turning the 200th into a reconnaissance battalion, Cage led his unit into many of the SLDF's toughest battles against Rim Worlds Republic forces, culminating in participation with General Kerensky's task force that liberated Terra from Stephan Amaris' grasp. The 200th Dragoons had over fifty *Hussars*; they were extremely dangerous as an overrunning flanker force and many times managed to turn the tide of battle by destroying valuable supplies, capturing high-ranking commanders, and in at least three instances capturing the enemy's DropShip assets. Colonel Cage accepted General Kerensky's invitation to leave with the bulk of SLDF forces in the Exodus.

Cortez "Attila" Thomasin: Security advisor to Sheik Marsala Redmond of the "Caliphate of the Sands" on Astrokaszy, Thomasin stumbled upon an ancient HSR-200-D model during an intelligence operation against a rival Caliphate on Astrokaszy. A gifted pilot, Thomasin used his new prize to augment his Sheik's meager armored forces during the Sandstorm Plot in 3021, where he managed to spoil the Caliph Yezer's surprise attack. Using the laser's extended reach to great effect, he managed to disable Yezer's two *Wasps* before they could jump the Sheik's castle walls.

Busosenshi Orland Yamashita: Dishonored after the discovery of his yakuza ties, Yamashita was given a chance for redemption during Theodore's reforms. Assigned a "new" 300-D model from ComStar's hidden stockpiles, Yamashita was dropped behind Davion lines on Konstance during the War of 3039 and assisted the Third Dieron Regulars by spotting for their devastating artillery strikes. His disregard for his own personal safety while deftly maneuvering through the Lyran lines earned him honor and full acceptance back among the ranks of his peers.

HSR-300-D HUSSAR

Type: **Hussar**

Technology Base: Inner Sphere

Tonnage: 30

Battle Value: 543

Equipment

Internal Structure:

Engine: 270

Walking MP: 9

Running MP: 14

Jumping MP: 0

Heat Sinks: 10

Gyro: 3

Cockpit: 3

Armor Factor: 24

Mass

3

14.5

0

3

3

1.5

*Internal
Structure* *Armor
Value*

Head 3 3

Center Torso 10 4

Center Torso (rear) 1 1

R/L Torso 7 3

R/L Torso (rear) 1 1

R/L Arm 5 2

R/L Leg 7 2

Weapons and Ammo

Large Laser

Location **Critical**

CT 2

Tonnage

5

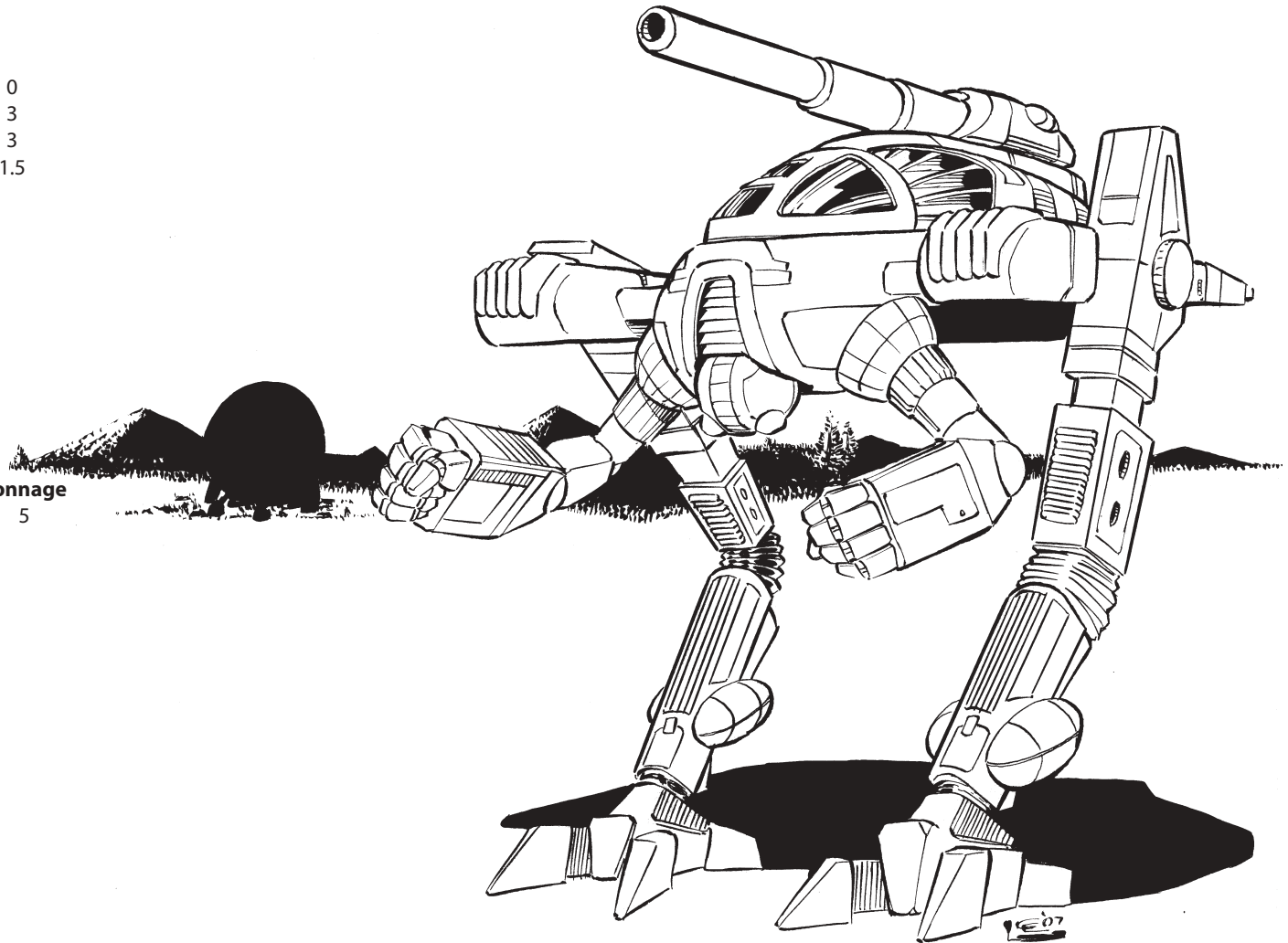

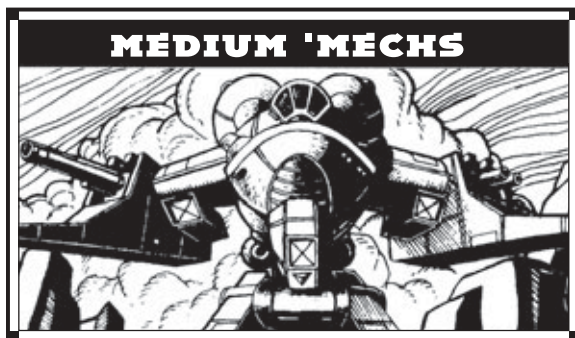

Mass: 40 tons

Chassis: Defiant V

Power Plant: Pitban 240

Cruising Speed: 64 kph

Maximum Speed: 97 kph

Jump Jets: None

Jump Capacity: None

Armor: Valiant Lamellor

Armament:

1 Defiance Type J Autocannon 5

1 Defiance B-1A Small Laser

1 Holly SRM 2 Launcher

Manufacturer: Defiance Industries

Primary Factory: Hesperus II (discontinued 3014)

Communications System: StarLink/Benicia
Model AS829G

Targeting and Tracking System: Targa-7, Vid-Com-17

Overview

When the Star League Council allowed the Houses to expand their private armies, many commissioned manufacturers to create new designs to fill out their ranks quickly. House Steiner, looking to bolster their conventional forces without going over the new BattleMech limits, introduced the *Sentinel* design in 2651. Both the Free Worlds League and the Federated Suns took an interest in the design, as did the Star League Defense Force, and all would acquire moderate amounts of this design, using them as low-cost units guarding installations and supply depots. The Succession Wars and the *Sentinel's* mediocre

performance turned it into a shunned design by many units, often sent to backwater systems to defend against bandits, but the fact that it was a 'Mech that could still be produced (albeit very slowly) kept the design barely alive.

The *Sentinel* line eventually had to be shut down due to lack of useable parts at the turn of the thirty-first century. The line would later be restarted during the early 3020s, but this time tooled to start producing the *Hatchetman*.

Capabilities

The original capabilities of the *Sentinel* were far more potent than the ones remaining during the later Succession Wars. Its rapid-fire KWI Ultra cannon, powerful yet prone to jamming, was quickly replaced with the sturdier but slower Defiance cannon, while its advanced SRM launcher was replaced with a standard SRM pack. The *Sentinel's* original A-1 small laser was replaced in 2678 with the more reliable B-1A series. However, the SRM feed mechanism had to be slightly moved, which often led to jamming issues when the 'Mech attempted to fire off an SRM volley while performing an abrupt (typically evasive) maneuver.

While the fix was easy enough outside of battle, there was no time to do so during combat. MechWarriors found that banging their *Sentinel's* chest with their right fist would eventually clear the problem, though this often caused more internal damage over time, making the feed mechanism yet more prone to jamming.

Foes would concentrate on a *Sentinel* doing a "chest thump" as they realized the BattleMech could not effectively return fire. This led to the destruction of hundreds of *Sentinels* over the years, and many pilots learned to simply retreat off the battlefield when their launcher jammed, further damaging the BattleMech's reputation.

Deployment

Prior to the revelation of the Com Guards and Ghost Regiments within the Draconis Combine, only a handful of *Sentinels* were believed to be in existence. Once carrying advanced technology, many were stripped of their advanced components for more favorable chasses, and the constant combat forced those that were not damaged beyond all hope to be rebuilt several times over. Only the

spread of the "hereditary" BattleMech philosophy, or the passing down of increasingly rare 'Mechs from one generation of a family to the next, kept this design alive.

With the discovery of the Helm Memory Core and the slow unlocking of its secrets, the remaining manufacturers have begun to increase 'Mech production. MechWarriors who have had the chance have exchanged their unfavorable designs for newer, preferable models. Many thought that the *Sentinel* would be the first design phased out completely during the Succession Wars not due to combat but instead simply by being obsolete.

But the War of 3039 breathed new life into the *Sentinel's* existence. Almost a hundred new machines, some even bearing their original rapid-fire autocannon, appeared in the ranks of the newly created Ghost Regiments, shocking and confusing both Davion and Steiner troops alike.

Variants

With so few *Sentinels* operational, there are no common variants, though the occasional MechWarrior has replaced their damaged autocannons with a large laser or PPC and extra heat sinks or armor.

Notable MechWarriors

Erik Vorster: A former SLDF MechWarrior, Vorster followed his commander, Kieran McKinnon, to Kentares IV where they swore fealty to House Davion before the start of the First Succession War. He was one of twelve soldiers who would go on to become the famous Fox's Teeth, an independent company of the Seventh Crucis Lancers. As advanced equipment became scarce, Vorster's *Sentinel* quickly reverted to a more primitive 3K version and was passed down to his son several decades later, where it was eventually destroyed on the battlefield and replaced by a salvaged *Stinger*. It is said that the 'Mech finally succumbed to damage after all its ammunition was exhausted, arms blown off, and it still killed one more enemy (stories say it was the subsequently salvaged *Stinger*) using its small laser before the *Sentinel* literally fell to pieces.

STN-3K SENTINEL

Type: **Sentinel**

Technology Base: Inner Sphere

Tonnage: 40

Battle Value: 652

Equipment

Internal Structure:

Engine: 240

Walking MP: 6

Running MP: 9

Jumping MP: 0

Heat Sinks: 10

Gyro: 3

Cockpit: 3

Armor Factor: 96

Internal Structure	Armor Value
--------------------	-------------

Head	3	9
------	---	---

Center Torso	12	12
--------------	----	----

Center Torso (rear)		7
---------------------	--	---

R/L Torso	10	10
-----------	----	----

R/L Torso (rear)		5
------------------	--	---

R/L Arm	6	8
---------	---	---

R/L Leg	10	11
---------	----	----

Mass

4

11.5

0

3

3

6

Weapons

and Ammo

	Location	Critical	Tonnage
--	----------	----------	---------

AC/5	LA	4	8
------	----	---	---

Ammo (AC) 40	LT	2	2
--------------	----	---	---

SRM 2	RT	1	1
-------	----	---	---

Ammo (SRM) 50	RT	1	1
---------------	----	---	---

Small Laser	RT	1	.5
-------------	----	---	----

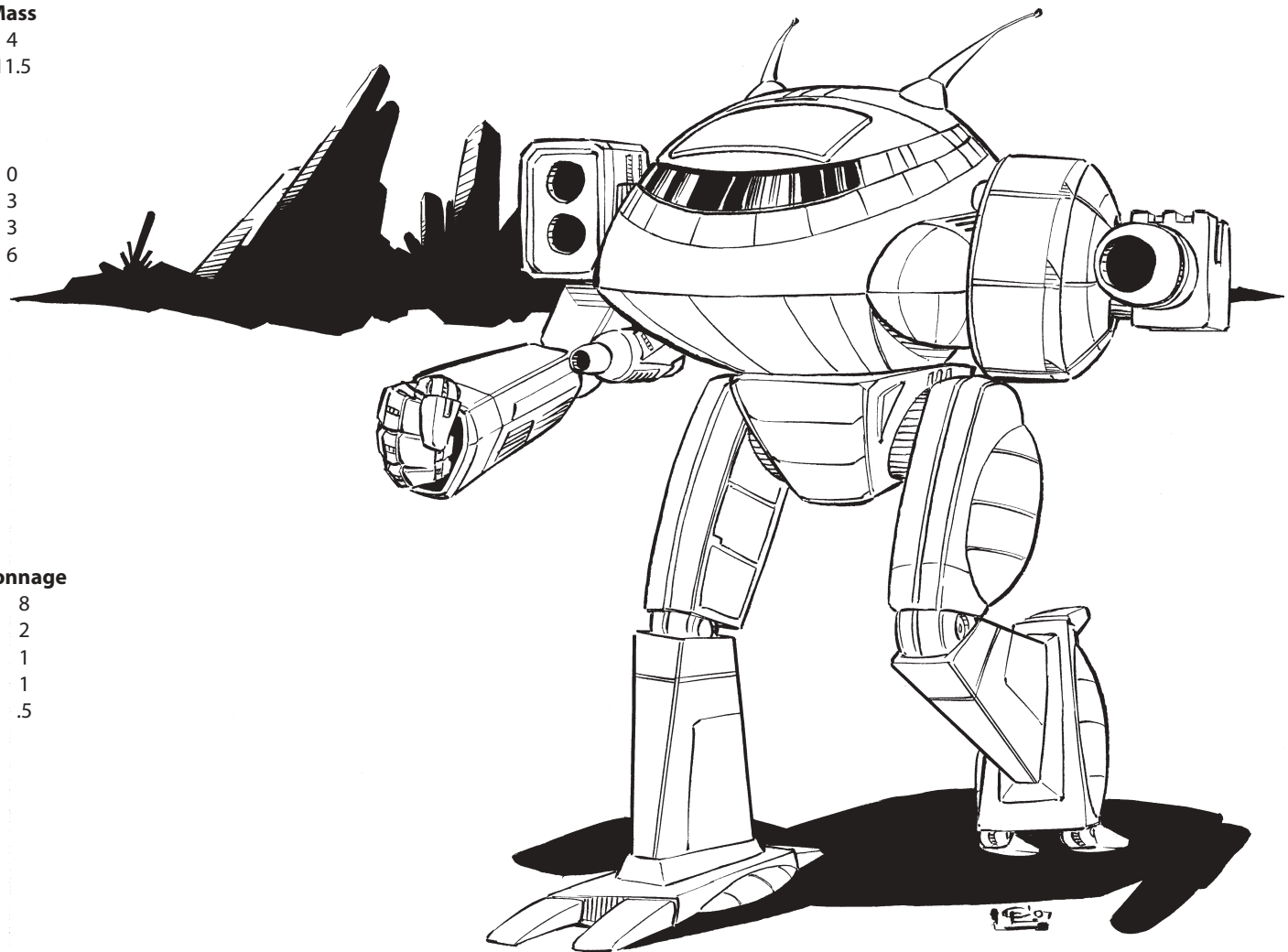

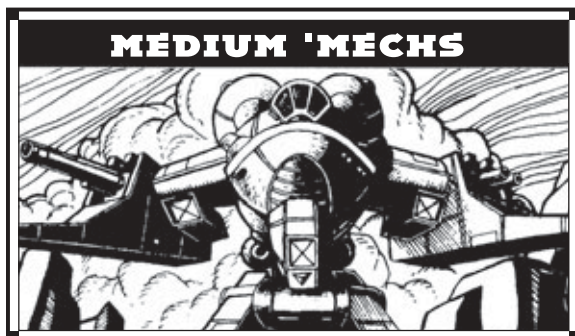

Mass: 45 tons
Chassis: Ost Standard
Power Plant: GM 180
Cruising Speed: 43 kph
Maximum Speed: 64 kph
Jump Jets: Northrup 750
Jump Capacity: 120 meters

Armor: Kilosh 1000

Armament:

- 1 Jackson Dart-10 LRM Launcher
- 1 Nightwind Large Laser
- 2 Starflash Small Lasers
- 1 Totschlagen-6 SRM Launcher

Manufacturer: Maltex Corporation

Primary Factory: Errai (destroyed 2835)

Communications System: Ostmann AMB

Targeting and Tracking System: Scrambler-7 Series

Overview

One of the premier urban fighting BattleMechs of its time, the *Wyvern* was commissioned in 2660 and showed the hallmark toughness of its larger sibling from Maltex, the *Thug*. Though many scoff at the *Wyvern's* intended role of "crowd control," in practice *Wyverns* were ideal for being the first into a city to pacify it, or as a last line of defense to keep it out of enemy hands.

Capabilities

Though not a fast 'Mech, the Northrup 750 Jump jets allowed *Wyverns* to rapidly maneuver around all but the tallest buildings, giving it an advantage against faster BattleMechs that lacked jump capability. In urban combat, it is standard practice for a *Wyvern* to use this maneuverability to get into the target's rear arc, where the *Wyvern's* potent weaponry could wreak havoc. The *Wyvern's* long-range missiles and large laser are effective against most designs of equal or lesser weight.

Though it lost armor and its advanced ammunition bays in the Succession Wars, the *Wyvern* was able to retain most of its capabilities. Armored more heavily than most 45-ton chasses, it has been said that a lance of *Wyverns* could withstand punishment many times greater than its peers. During the changeover in materials, the LRM ammunition feed was re-routed, which reduced the risk of ammunition cooking off from the heat of the fusion engine in an intense battle.

Deployment

Every Successor State possesses at least a single *Wyvern* within their ranks, often in units assigned to garrison heavily industrialized worlds. With the fighting moving out of cities and into open fields at the start of the Third Succession War, many MechWarriors found the *Wyvern's* capabilities lacking in the change of terrain.

Maltex, having found that advanced technologies and components were becoming harder to produce, began stripping *Wyverns* of their CASE and endo-steel so they could be used on their *Thug* design, though eventually even that design had to be downgraded.

Maltex ceased production altogether in 2835 when a battalion of raiders destroyed its Errai manufacturing plant and surrounding towns. Carefully disguising their appearance to prevent retaliation or identification, the raiders sowed a swath of destruction aimed at the city of New Atlanta. As the city braced for the worst, a single lance of *Wyverns*, presumably the remnants of the Maltex security, intercepted the larger group less than a kilometer out from the city outskirts. The four medium 'Mechs used their jump jets to leap into the middle of the enemies' formation, firing

furiously and causing many of the raiders to hit their fellow soldiers in the exchange. Enraged at the humiliation of being bested by only four small BattleMechs, the raiders followed the defending *Wyverns* as they went around the city and over the nearby mountain. The populace breathed a sigh of relief, but they worried the superior numbers would allow the raiders to return to finish what they started.

A day later, eight heavily damaged raiders reappeared. But instead of victoriously entering the city, they moved at full speed around the city and back to the landing zone. Intercepted communications overheard frantic transmissions between them and their DropShips, talking about the four horsemen of the apocalypse and demons. While the raiders' communications were nonsensical, the city of New Atlanta took the words to heart and erected a monument to their unknown defenders, called the "Four Horsemen of Errai."

Variants

With its already diverse armaments, few variants of the *Wyvern* have been attempted.

Notable MechWarriors

The Four Horsemen of Errai: Though feared by most populaces as harbingers of death and destruction, the Four Horsemen of Errai are held in quite different regard, and their legend did not end with the defense of New Atlanta in 2835. When an earthquake hit the city, a scant five years after the destruction of Maltex, it caused a series of massive avalanches from the nearby mountain. Almost a hundred civilians were trapped in their homes, which were built into the mountain. While rescuers desperately attempted to free the trapped families, four unregistered *Wyverns* appeared, battered and looking as if they had been in a long battle. Without a single transmitted communication, they worked day and night using their hand actuators and lasers to cut and clear rubble and debris. Three days later, all the surviving civilians were freed with only a handful of fatalities. The *Wyverns* quietly marched back over the mountain, and by the time the town was able to send aircraft to find the 'Mechs, they had disappeared without a trace.

WVE-6N WYVERN

MEDIUM 'MECHS

257

Type: **Wyvern**

Technology Base: Inner Sphere

Tonnage: 45

Battle Value: 1,005

Equipment

Internal Structure:

Engine: 180

Walking MP: 4

Running MP: 6

Jumping MP: 4

Heat Sinks: 12

Gyro: 2

Cockpit: 3

Armor Factor: 136

Mass

4.5

7

2

2

3

2

2

3

8.5

	Internal Structure	Armor Value
--	--------------------	-------------

Head	3	9
------	---	---

Center Torso	14	18
--------------	----	----

Center Torso (rear)		7
---------------------	--	---

R/L Torso	11	14
-----------	----	----

R/L Torso (rear)		5
------------------	--	---

R/L Arm	7	12
---------	---	----

R/L Leg	11	20
---------	----	----

Weapons

and Ammo

	Location	Critical	Tonnage
LRM 10	CT	2	5
Ammo (LRM) 12	LT	1	1
Large Laser	RA	2	5
2 Small Lasers	RA	2	1
SRM 6	RT	2	3
Ammo (SRM) 15	RT	1	1
Jump Jet	LT	1	.5
Jump Jet	RT	1	.5
Jump Jet	LL	1	.5
Jump Jet	RL	1	.5



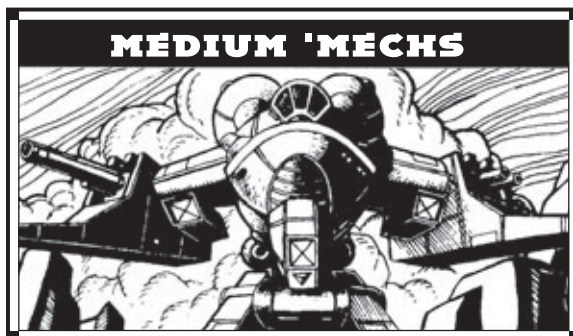

Mass: 50 tons

Chassis: Hollis Mark 1A

Power Plant: Magna 250

Cruising Speed: 54 kph

Maximum Speed: 86 kph

Jump Jets: None

Jump Capacity: None

Armor: Bulldog Standard

Armament:

2 RAMTech 1200 Large Lasers

1 Ceres Arms Medium Laser

1 Exostar Small Laser

Manufacturer: Cosara Weaponries

Primary Factory: Northwind (destroyed 2786)

Communications System: Garret T-11b

Targeting and Tracking System: Garret D2j

Overview

Originally designed as a raider and guerilla fighter in 2719, the *Crab* became so popular with pilots and technicians that it was believed it would eventually become the Star League's new standard-issue frontline medium BattleMech. Unfortunately, the dissolution of the Star League and subsequent Exodus ended such ambitions by Cosara. Only a thousand were built before their production line on Northwind was heavily damaged, leaving the *Crab* to slowly wither away while other designs took the spotlight.

Capabilities

Designers wanted a 'Mech that could remain behind enemy lines almost indefinitely, and they built the *Crab* accordingly. Every piece of equipment on the machine could be easily accessed and repaired, and most can be replaced with off-the-shelf parts of various different brands. Because of this, the term "Crabwalk" came about, synonymous with easy duty. The *Crab's* weapons were forced to be uninspired due to its design parameters; a pair of arm-mounted large lasers in protective claw-like housings, backed by a single medium and a small laser. While not overly powerful, the all-energy armament leaves the *Crab* able to operate behind enemy lines for extended periods of time. Unfortunately the *Crab* lacked jump jets, slowing it on built-up terrain. The design initially lacked hand actuators as well, forcing the 'Mech to be accompanied by other machines to gather captured supplies when raiding stockpiles. Cosara later rectified this issue with refit kits that allowed the installation of one or both hand actuators, depending on the MechWarrior's preference.

The only pieces of advanced and finicky equipment on the *Crab* were its ferro-fibrous armor and electronics system. The ability to manufacture the armor was lost quickly, and many MechWarriors were forced to place standard plating on the machines, resulting in a slight loss in protection. The nine tons of armor, however, was quite adequate for a competently handled 50-ton 'Mech.

The electronics system was a different story. The Dalban K (with an integrated 650 RND subsystem) was able to keep track of its exact location on the world and the approximation of any known units on the planet, even without the use of observation satellites. Monitoring all short-wave bands and radio frequencies, the system could even forecast enemy troop movements and plot waypoints for friendly troops through enemy-held territory. While the technology to repair and manufacture the Dalban system remained available, the system proved fragile and easily damaged, even out of combat, and many pilots voluntarily stripped them out for much more rugged systems. Though some of the original electronics suites still existed, only prestigious mercenary units and House regiments have had the technical support to maintain them.

Deployment

While the *Crab* assembly line was damaged heavily during the early Succession Wars, technicians on Northwind were able to keep the lines active as a refit and repair facility, using the parts manufactured by the remainder of the plant to rebuild many of the crippled machines. Though not every damaged *Crab* could make it back to Northwind for repair, enough did so that the unlocking of the Helm Memory Core allowed the remaining hundred or so (not including those hidden by ComStar over the centuries or those gifted to the Draconis Combine in the 3030s) to be refitted back to their original advanced armor configuration.

Variants

The only variants of the Succession War-era *Crab* were the models gifted to the Draconis Military by ComStar, and those refitted in the field by the various MechWarriors. Like the more advanced version given to the Combine, these lacked the Dalban and 650 RND series of electronic suites, instead replacing them with the more inferior Garret line of communications and targeting systems. These changes were so minor that they did not warrant a designation change.

Notable MechWarriors

MechWarrior Samantha Danton: A former SLDF MechWarrior, Danton refused to follow Kerensky into exile and instead pledged allegiance to Prince Davion alongside her commander, forming an independent raiding company under Captain McKinnon. Danton was a habitual gambler, even voluntarily trading her original *Crab's* ferro-fibrous for standard plate to cover several bets. But unlike most, Danton had a knack for winning consistently. She amassed a huge fortune and used those funds to keep her *Crab* in topnotch condition throughout the First Succession War. And she was wise enough to invest her fortunes in several upstart companies years before retiring from her unit, which she did a decade later to raise her sole living relative, a young nephew. That fortune grew into a sizable estate on Kestrel.

CRB-20 CRAB

Type: **Crab**

Technology Base: Inner Sphere

Tonnage: 50

Battle Value: 1,143

Equipment

Internal Structure:

Engine: 250

Walking MP: 5

Running MP: 8

Jumping MP: 0

Heat Sinks: 16

Gyro: 3

Cockpit: 3

Armor Factor: 144

Internal Structure	Armor Value
--------------------	-------------

Head	3	9
------	---	---

Center Torso	16	18
--------------	----	----

Center Torso (rear)		7
---------------------	--	---

R/L Torso	12	14
-----------	----	----

R/L Torso (rear)		5
------------------	--	---

R/L Arm	8	14
---------	---	----

R/L Leg	12	22
---------	----	----

Mass

5

12.5

6

3

3

9

Weapons

and Ammo

	Location	Critical	Tonnage
--	----------	----------	---------

Large Laser	LA	2	5
-------------	----	---	---

Large Laser	RA	2	5
-------------	----	---	---

Medium Laser	CT	1	1
--------------	----	---	---

Small Laser	H	1	.5
-------------	---	---	----

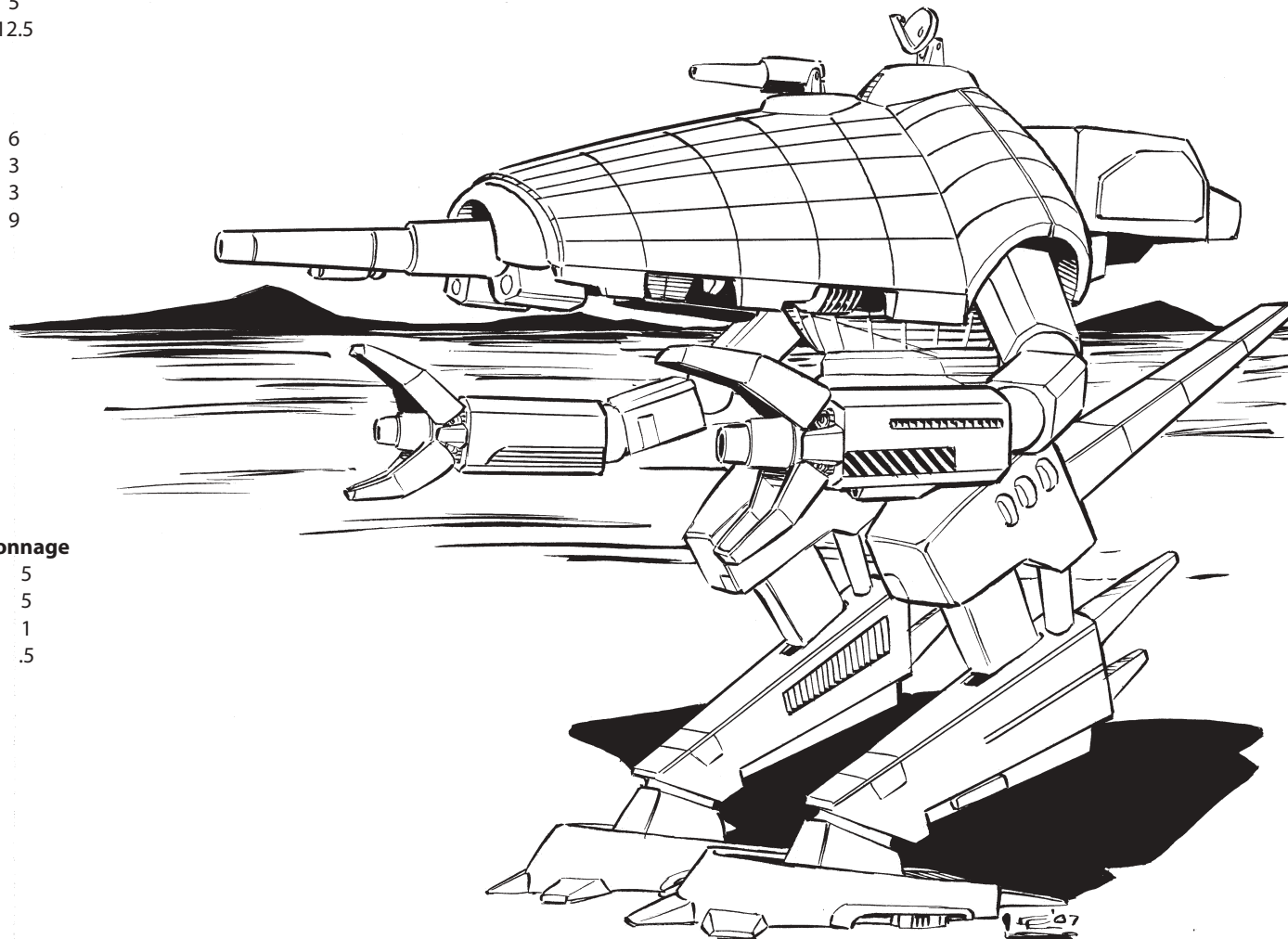

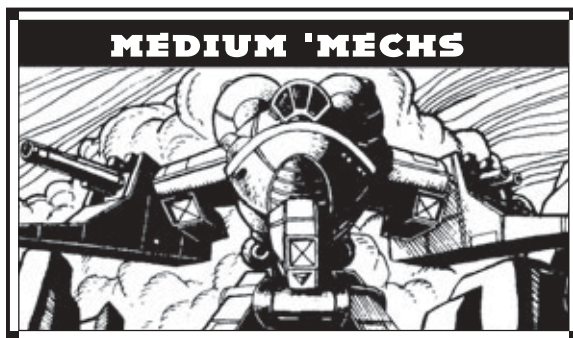

Mass: 55 tons

Chassis: Technicon-1

Power Plant: CoreTek 275

Cruising Speed: 54 kph

Maximum Speed: 86 kph

Jump Jets: None

Jump Capacity: None

Armor: Leopard V

Armament:

1 Holly-5 LRM Launcher

2 Magna Medium Lasers

3 Hovertec-6 SRM Launchers

Manufacturer: General Dynamics

Primary Factory: Ozawa

Communications System: OmniComm 3

Targeting and Tracking System: Starbeam 3000

Overview

The *Kintaro* is a powerful sight to behold, belying its medium size. Built for the Star League to showcase the Narc missile designator, it was a powerful team player until the liberation of Terra from the Usurper led to the *Kintaro* factory on Mars being shut down. Attrition contributed to the near extinction of the *Kintaro* before the Third Succession War, but General Dynamics was able to rebuild a factory on Ozawa to produce the design. However, General Dynamics was unable to reproduce the original's Narc Beacon, advanced heat sinks, and armor.

Capabilities

With eleven tons of Leopard V armor, the *Kintaro* mounts more armor than many heavier units, and with a top speed of 86 kph, it can easily pace most medium and heavy 'Mech formations. The long-ranged missile launcher can assist other fire-support units but is often regarded as a nuisance. The real offensive firepower can be found in the *Kintaro*'s close-ranged weapons. Three SRM 6 packs are deceptively powerful, often doing more damage than a massive class 20 autocannon, though in a more distributed pattern. Twin medium lasers serve as a solid pair of back-up weapons, allowing a *Kintaro* running out of ammunition to make a fighting withdrawal.

The *Kintaro* is not a good solo unit due its limited ranged firepower, but it works well as a bodyguard unit or close-assault 'Mech, often able to go toe-to-toe with heavy 'Mechs at close range. The lack of heat sinks means the pilot needs to keep an eye on his heat levels in combat. With a reliance on ammunition-based weaponry, the *Kintaro* does not make an ideal deep raider or guerrilla fighter, but with two hand actuators and a good offensive punch, the *Kintaro* is good for supply raids.

Deployment

Most of the KTO-18 models can be found with former Federated Suns units in the Federated Commonwealth. More prevalent are the Star League models in the Draconis Combine. These are concentrated in Ghost units as well as some Sword of Light regiments. The Com Guards also field a good number of Star League *Kintaros*.

These Star League models packed more punch than the FedCom units were used to. Steiner and Davion troops quickly adapted to the different weapons load of the Star League *Kintaros* in the War of 3039, but the advanced heat sinks allowed them to sustain fire longer than the FedCom *Kintaro*. This led to an overreaction where *Kintaros* would be targeted more than necessary, and other Combine units were able to freely engage their distracted opponents.

On Sarna in the Fourth Succession War, a pair of Capellan *Cataphracts* and *Vindicators* closed on a trio of Davion *Kintaros* backed by a *Marauder*. The *Cataphracts*

concentrated fire on the *Marauder* while the *Vindicators* attempted to hold off the *Kintaros*. With their thick armor, the *Kintaros* did not shy from the Capellan PPCs and used their superior speed to close with the smaller 'Mechs. At short range, the *Vindicators*' weaponry proved inadequate, and the three *Kintaros* crushed the *Vindicators* at the same time the *Marauder* fell. The heavier *Cataphracts* wheeled on the trio, concentrating fire. The *Kintaro* again closed with the enemy, firing short-ranged missiles as fast as they could. While the Capellans' armor would normally have withstood the beating, the missiles exploited the damage wrought by the *Marauder*. After an ammo explosion destroyed one of the *Cataphracts*, the other surrendered, its engine shielding almost shattered.

Variants

The limited production of the *Kintaro* has been confined to the KTO-18. However, ComStar gave the Draconis Combine downgraded KTO-20 models for use in the War of 3039, which replaced the original's Narc Beacon with a large laser.

Notable MechWarriors

Lieutenant Jack Kidd: Despite being a good pilot, Kidd's personality overshadows his battlefield performance. He declares himself a privateer and dresses and acts like a 17th century pirate. His superiors let his personality quirks slide because he is a competent lance commander. Opponents trying to close on his lancemates, two *Trebuchets* and a *Dervish*, are rarely ready for the short-range punch that Kidd's *Kintaro*, "The Adventure 'Mech," can unleash. Kidd's comrades enjoy his entertaining personality but wonder what will happen to his ego should he receive a promotion.

Busosenshi Rachel Sakurai: Rising from the streets of Styx to become a MechWarrior, Rachel was very conscious of civilian casualties during the War of 3039. As a member of the Fourth Ghost Regiment, she achieved four kills while saving St. Christina's Hospital, which was later used by the DCMS to care for injured soldiers.

KTO-18 KINTARO

Type: **Kintaro**

Technology Base: Inner Sphere

Tonnage: 55

Battle Value: 1,187

Equipment

Internal Structure:

Engine: 275

Walking MP: 5

Running MP: 8

Jumping MP: 0

Heat Sinks: 10

Gyro: 3

Cockpit: 3

Armor Factor: 176

Internal Structure	Armor Value
--------------------	-------------

Head	3	9
------	---	---

Center Torso	18	26
--------------	----	----

Center Torso (rear)		9
---------------------	--	---

R/L Torso	13	18
-----------	----	----

R/L Torso (rear)		7
------------------	--	---

R/L Arm	9	18
---------	---	----

R/L Leg	13	23
---------	----	----

Mass

5.5

15.5

0

3

3

11

Weapons and Ammo

	Location	Critical	Tonnage
--	----------	----------	---------

Medium Laser	RA	1	1
--------------	----	---	---

SRM 6	RT	2	3
-------	----	---	---

Ammo (SRM) 30	RT	2	2
---------------	----	---	---

Medium Laser	LA	1	1
--------------	----	---	---

LRM 5	LA	1	2
-------	----	---	---

SRM 6	LA	2	3
-------	----	---	---

Ammo (LRM) 24	LT	1	1
---------------	----	---	---

Ammo (SRM) 15	LT	1	1
---------------	----	---	---

SRM 6	CT	2	3
-------	----	---	---

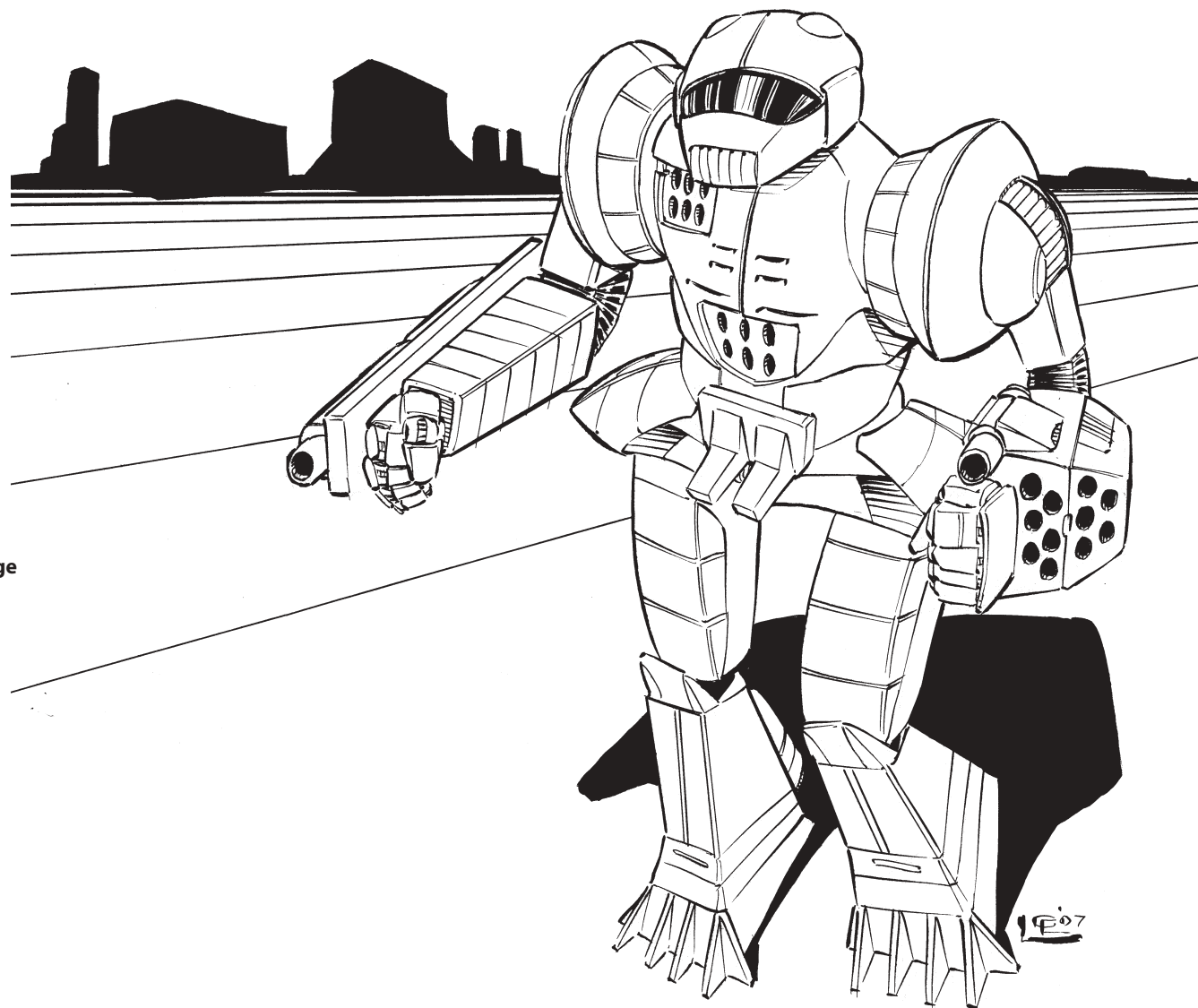

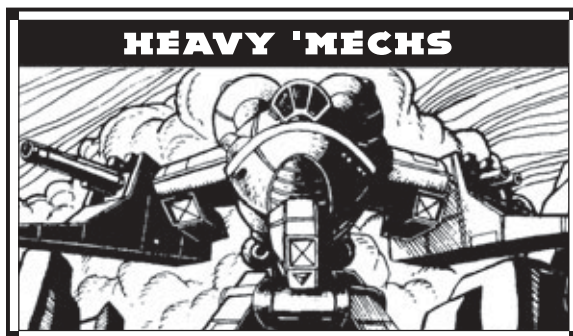

Mass: 60 tons

Chassis: Bergan XI

Power Plant: Vlar 300

Cruising Speed: 54 kph

Maximum Speed: 86 kph

Jump Jets: None

Jump Capacity: None

Armor: StarSlab/2

Armament:

- 1 Mydron Model B Autocannon
- 1 Harpoon-6 SRM Launcher
- 2 Magna Mark II Medium Lasers
- 2 Martell Small Lasers

Manufacturer: Bergan Industries

Primary Factory: New Earth (destroyed 2776)

Communications System: Garret T-11C

Targeting and Tracking System: Mercury-IV

Overview

In 2602 Bergan Industries released the *Champion* as a heavy 'Mech dedicated to fast strike and attack duties but speedy enough for heavy recon uses as well. Although other 'Mechs performed better for less cost, Bergan spent enough on their marketing to win an initial order of two hundred machines from the Star League, and the *Champion* went on to become one of the most popular 'Mechs of the SLDF during the many "brush wars" the League fought during those years. Although its detractors often pointed out its flaws, the *Champion's* performance in battle let it hold onto its reputation—and its place in the military—for quite a long time.

During the Succession Wars, a number of *Champions* served in the Successor State militaries, although they all eventually lost the advanced systems the Star League had built into them. The remaining 'Mechs, however, performed to the same level as their high-tech predecessors in nearly every engagement, keeping the 'Mech popular, if rare.

Capabilities

A massive Vlar 300 fusion engine that masses nearly a third of the *Champion's* total mass provides enough power to push the 60-ton 'Mech to speeds in excess of 85 kph, speeds normally reserved for lighter medium BattleMechs. While this speed costs the *Champion* in several ways, most notably armor protection, the Bergan engineers felt this swiftness would offset the disadvantage.

The *Champion's* weapons are powerful enough, with a Mydron Model B autocannon as the centerpiece. An adequate supply of ammunition means that the cannon can continue to fire while the *Champion* closes the range enough to bring its other weapons, a six-tube Harpoon-6 SRM system and two banks of lasers, to bear. Although firing all of these weapons together can overload the *Champion's* sub-par heat exchangers, a careful MechWarrior can usually manage this flaw with ease.

The *Champion* serves well in many lances, as its weapons lend themselves to fighting in a variety of ranges and climes. This has the unfortunate effect, however, of making the *Champion* almost too useful; many commanders cannot decide which role to assign the 'Mech, and so it languishes in between several.

Deployment

The *Champion* served in many independent Star League BattleMech regiments, and once it became outpaced by newer designs the *Champion* was sold to the member state armies. The Succession Wars took a great toll on the *Champion*, but a few examples still exist in every Successor State. House Liao controls most of them, but that edge is only one or two machines over the next prosperous House on the list, House Steiner.

As with many other Star League 'Mechs and vehicles, the *Champion* has reappeared in the ranks of the Com Guards, where it stood with distinction. House Liao pressed several

times for more information on these systems in the hopes of upgrading their own *Champions*, but the secretive organization has rebuffed them all. The Capellans were left to unlock the secrets of the *Champion* on their own in the 3040s.

Variants

A common but difficult field modification for the *Champion* during the Star League involved replacing the substandard heat sinks with double-strength models, but Bergan never sanctioned this model with a factory variant, perhaps afraid that doing so would admit to a weakness in their own design.

Notable MechWarriors

Captain Aristotle Crandall: Captain Crandall, the regimental Gunslinger for his unit, engaged in more than sixty duels against Kuritan MechWarriors during the Hidden War, ending with a record of twenty-seven wins, thirty-one losses, and three draws. He was finally killed in a duel with a Kurita *Lancelot* after destroying the *Lancelot's* fusion engine. The resulting explosion killed both MechWarriors.

Acolyte VII Aristoxenos Crandall: A descendant of Captain Crandall, Acolyte Crandall pilots a *Champion* in ComStar's Ninety-first Division. He has studied every record ComStar has available on Captain Crandall and his battles and has obtained permission to paint his *Champion* in the same scheme as his ancestor's when parade dress is not called for. Unfortunately for him, Acolyte Crandall's skills in the 'Mech do not equal his ancestor's, and his mock "duels" in the simulator against his fellow Com Guards normally result in his death.

Force Commander Bors Krepyk: Bors Krepyk commands the Lesnovo Planetary Militia 'Mech complement—three 'Mechs—from the cockpit of his dilapidated *Champion*. The FWLM relegated the near-scrap 'Mech to the militia after deeming it not worth the expense of maintaining. Although its cost him nearly every favor owed him, Krepyk has refurbished the 'Mech to near-operational status, although his attempts to fit an Emperor cannon in the space designed for the Mydron keep failing.

CHP-2N CHAMPION

Type: **Champion**

Technology Base: Inner Sphere

Tonnage: 60

Battle Value: 1,116

Equipment

Internal Structure:

Engine: 300

Walking MP: 5

Running MP: 8

Jumping MP: 0

Heat Sinks: 10

Gyro: 3

Cockpit: 3

Armor Factor: 128

Mass

6

19

0

3

3

8

	Internal Structure	Armor Value
--	--------------------	-------------

Head	3	9
------	---	---

Center Torso	20	22
--------------	----	----

Center Torso (rear)		9
---------------------	--	---

R/L Torso	14	16
-----------	----	----

R/L Torso (rear)		5
------------------	--	---

R/L Arm	10	10
---------	----	----

R/L Leg	14	13
---------	----	----

Weapons

and Ammo

	Location	Critical	Tonnage
--	----------	----------	---------

AC/10	RT	7	12
-------	----	---	----

Ammo (AC) 20	RT	2	2
--------------	----	---	---

SRM 6	LT	2	3
-------	----	---	---

Ammo (SRM) 15	LT	1	1
---------------	----	---	---

2 Medium Lasers	LT	2	2
-----------------	----	---	---

2 Small Lasers	CT	2	1
----------------	----	---	---

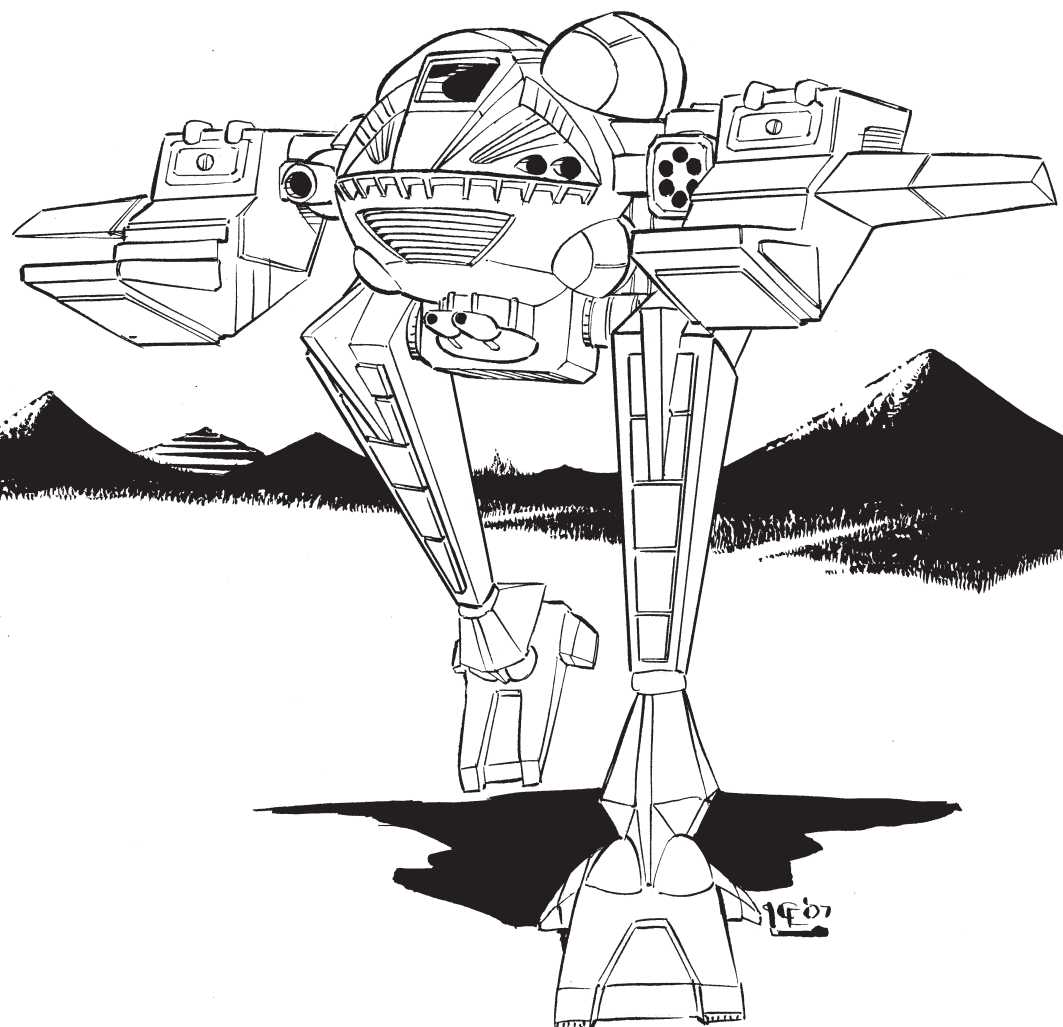

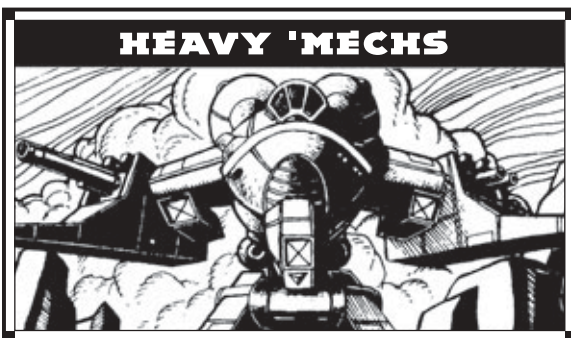

Mass: 60 tons

Chassis: LAW LNC25-02

Power Plant: Pitban 240

Cruising Speed: 43 kph

Maximum Speed: 64 kph

Jump Jets: None

Jump Capacity: None

Armor: Starshield

Armament:

1 Lord's Light PPC

2 Sunglow Heavy Lasers

1 Victory 23R Medium Laser

Manufacturer: Luthien Armor Works

Primary Factory: Luthien

Communications System: Sipher KIT-4

Targeting and Tracking System: Hawkeye B3

Overview

Krupp Stellar Technologies was a favorite of 'Mech manufacturers working for the Terran Hegemony and Star League. Producers of excellent weapons and computer systems, they enjoyed a good level of profits until finally deciding to get into the game themselves. After acquiring Saeder Manufacturing they received a contract from the Star League Quartermaster Command in 2581 to produce a quick-strike medium 'Mech with significant firepower that was not ammunition dependant. While very limiting, these requirements narrowed the choices that Krupp needed to make, and they focused on the power plant and worked their way out. Field trials later that year were successful and

the *Lancelot* was pushed into full production. While the first run was a modest 250 units, the Star League extended the order afterward despite the high price tag.

Krupp's facilities on Mars were destroyed during the Amaris Coup, as were many *Lancelots* in the heavy fighting during Kerensky's struggle to reclaim the Terran Hegemony. The design had almost become extinct before Luthien Armor Works obtained copies of the blueprints after the Second Succession War. Though they managed to keep the 'Mech in limited production, its capabilities were significantly reduced. The ravages of centuries of warfare have forced the *Lancelot* into a role for which it was never designed, with equipment that cannot keep it alive for long against anything but the lightest BattleMechs. While it still packs a considerable punch, it no longer possesses the speed or heat-dissipation capability to deliver its formidable firepower consistently and safely.

Capabilities

The deadly Lord's Light PPC serves as the *Lancelot's* primary weapon system. Concentrated PPC fire opens huge rents in most BattleMechs' armor, enabling the *Lancelot's* secondary weapon systems to seriously damage the enemy's chassis. The *Lancelot's* armor is thin but adequate to protect its main gun.

The twin arm-mounted Sunglow large lasers continue the job at closer ranges. Together, they can ablate sixty percent more armor than the PPC. If a *Lancelot's* pilot is willing to risk shutdown from overheating, he can use all three weapons to create a withering hail of fire.

The biggest problem with the LNC25-02 is that it has lost its ancestor's speed, being limited to 64 kph, and it lacks the armor to withstand more than a few solid hits. Because it has limited armor and average speed, modern pilots have taken to calling the *Lancelot* the "Coffin."

Deployment

Prior to the Exodus, *Lancelots* were fielded in almost all militaries in fast strike units. By the end of the Second Succession War, the loss of technology and production had led to their virtual extinction. Currently less than a dozen functional or even salvageable *Lancelots* can be

found throughout the Inner Sphere. Another couple of hundred of LAW's lower-tech LNC25-02 version can be found, mainly in the Draconis Combine, where they serve as fire-support units in a role similar to the Federated Suns' heavier *JagerMech*.

Variants

The original design moved fifty percent faster thanks to an advanced engine and mounted six less heat sinks, though they were double-capacity models. Some warriors would upgrade the large lasers or PPCs with extended-range versions, but Krupp never made a production model so equipped. Prior to Amaris seizing Terra, Krupp had been field-testing a new prototype, the -01X, using more advanced technology. An advanced endo-steel skeleton allowed the addition of jump jets while ferro-fibrous armor was added to increase protection, and the large lasers were upgraded to ER versions. Reports from pilots indicate that the jump jets added little, and more armor or heat sinks would be preferable. Krupp, though, never had a chance to make those changes.

Notable MechWarriors

Captain Edward N. Smith: As a member of the Northwind Highlanders, Captain Smith has risen quickly in his five years since graduating from Northwind's Academy. As if being the able commander of Smith's Watch, a heavy company, wasn't enough, he is one of the unit's hand-to-hand combat instructors. Smith had been piloting a *Marauder*, but with the Highlanders now working for the Federated Suns, the NAIS has lent some technical support to bring his family's *Lancelot*, one of the two surviving -01Xs, back into operational condition in exchange for being able to study it. This aid paid off for both parties when his company engaged some raiders, and damage to his weapons forced Smith to attempt a death from above attack against the enemy commander not once, but twice. The irony is that the Combine leader was piloting a *Highlander*, another Star League relic, known for death from above attacks nicknamed the "Highlander Burial."

LNC25-02 LANCELOT

HEAVY 'MECHS

265

Type: **Lancelot**

Technology Base: Inner Sphere

Tonnage: 60

Battle Value: 1,236

Equipment

Internal Structure:

Engine: 240

Walking MP: 4

Running MP: 6

Jumping MP: 0

Heat Sinks: 19

Gyro: 3

Cockpit: 3

Armor Factor: 152

Mass

6

11.5

9

3

3

9.5

*Internal
Structure* *Armor
Value*

Head 3 9

Center Torso 20 21

Center Torso (rear) 16 16

R/L Torso 14 16

R/L Torso (rear) 10 10

R/L Arm 10 14

R/L Leg 14 14

Weapons

and Ammo

Location **Critical** **Tonnage**

PPC RT 3 7

Large Laser RA 2 5

Large Laser LA 2 5

Medium Laser CT 1 1

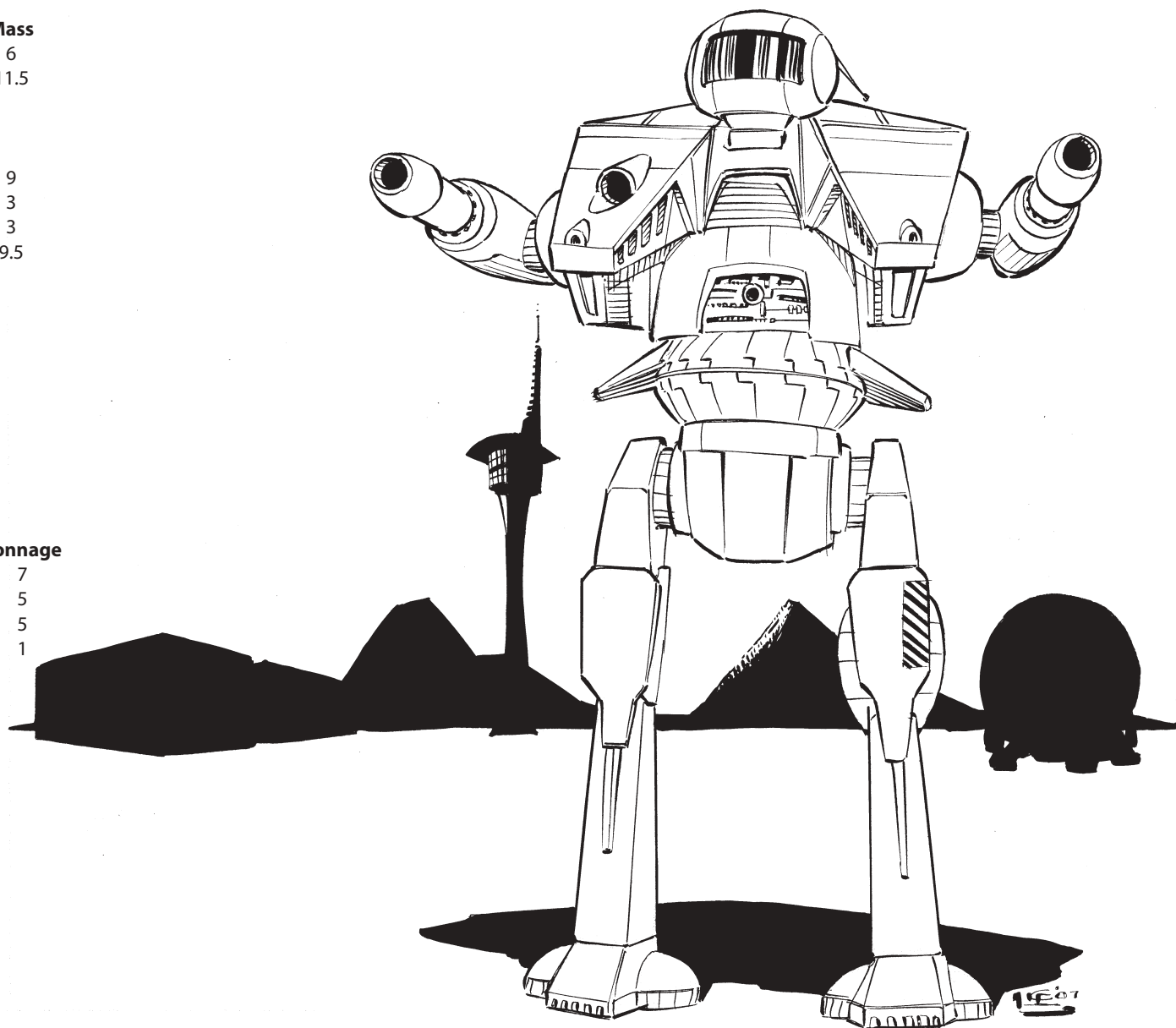

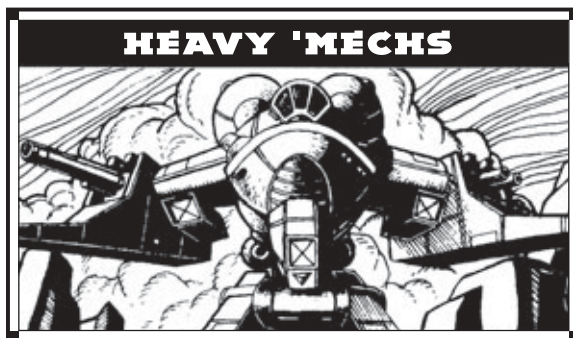

Mass: 65 tons

Chassis: KetoBond

Power Plant: Magna 260

Cruising Speed: 43 kph

Maximum Speed: 64 kph

Jump Jets: None

Jump Capacity: None

Armor: Maximillian 100

Armament:

2 Doombud Long-Range Missile 20 Racks

1 Hovertech Short-Range Missile Quad

1 Voelkers 200 Machine Gun

Manufacturer: Earthwerks Incorporated

Primary Factory: Calloway VI (refits only)

Communications System: Neil 5000

Targeting and Tracking System: RCA Instatrac Mark XII

Overview

The Star League wanted a mobile fire-support unit, and the original *Bombardier* delivered that using the cutting-edge technology available at the time. The destruction of the Succession Wars nearly eliminated the remaining *Bombardiers* (less than one thousand were built for the Star League). With Wakazashi Enterprises content to let the design die out, Earthwerks Inc. acquired a license to produce parts for the 'Mech for a minimal fee. With the Successor States eager for any 'Mechs they could get their hands on, even one with as poor a reputation as the *Bombardier*, Earthwerks began to refit modest numbers of the 'Mech after noticing that the basic armament and chassis would work with a smaller engine.

Capabilities

At half a kilometer away, opponents often can't tell the difference between a *Bombardier*, an *Archer*, or a pair of *Atlases*. That is how most *Bombardier* pilots would prefer to keep it. The 'Mech's formidable Doombud missile launchers can deal out damage at a range that few 'Mechs can compete with. However, it is undergunned at short ranges. It is well armored, though, and a short-range missile launcher gives it some punch to ward off light units that get inside the arming distance for Doombuds. The current model lacks the Star League version's ability to exceed 85 kph, leaving it with a conventional speed for its tonnage. An anti-missile system previously gave the *Bombardier* an advantage in duels with other missile platforms, but the advanced system was replaced with a machine gun during the Succession Wars. The biggest failing lies with its biggest asset: the *Bombardier* only carries twelve salvos for the Doombuds. After a few minutes of combat, it can easily find itself out-gunned and out-maneuvered by light 'Mechs.

Deployment

While most *Bombardiers* are found in the Free Worlds League or Draconis Combine, a few have shown up in other areas. Most military equipment is forbidden to be sold on the open market, but the second-line *Bombardier* is not subject to such stringent restrictions, and the mercantile Free Worlds League was particularly happy to market the refurbished BMB-10D abroad. Most *Bombardiers* are relegated to militia and reserve units. However, the Federated Commonwealth redeployed most of its *Bombardiers* to cadre units and academies. While the low amount of munitions deters traditional military forces, these training units are rarely far from resupply.

Bombardiers were instrumental in defeating Taurian forces at Pinard during the Periphery rebellions of the mid-2760s. A strike force of SLDF *Kintaros* and *Bombardiers* flanked the Taurian ground forces, cutting off their retreat. The force moved in fast and hit hard, with the *Kintaros*' Narc systems making the limited ammunition of the *Bombardiers* go even farther. Once the *Bombardiers* were out of ammo, the Taurians tried to fight their way through the strike force. However, the *Bombardiers* held their ground, slowing down their opponents. While many *Bombardiers* were lost, the main body was able to mop up the resistance.

Variants

Aside from the original 12D, there are no production variants of the *Bombardier*. Individual warriors have tried to remove weapons to fit more ammunition for the long-range launchers, while others have tried to fit smaller launchers with more endurance. Neither option works very well in the restrictive chassis, and attempts to fit lasers on the *Bombardier* have similarly failed.

Notable MechWarriors

Busosenshi David Hannsen: A new recruit in the First Genyosha, Hannsen is notable for having one of the few surviving 12D models. He fills a void in a fire-support company mainly made up of *Archers* and artillery vehicles. His superiors hope he fills the legacy of his mother, from whom he inherited his 'Mech. Kyoko Hannsen collected half a dozen kills on Misery as part of the Eighth Sword of Light. In fact, the limited ammo load might have been beneficial for her; she was able to hit medium units hard and pull back before they were able to do significant damage. The newer Dragoons didn't seem ready for a 'Mech with her speed and firepower, but they eventually inflicted shrapnel injuries that forced her retirement.

Captain Cindy Silver: Despite not having a cutting-edge 'Mech, powerful family name, or pretty face, Cindy has managed to rise to command a fire-support company in the Tenth Marik Militia. Opponents often assume that a lesser warrior is piloting the *Bombardier* and don't expect precise fire from it. Few opponents can stand up to four salvos of long-ranged missiles hitting for every six fired. Captain Silver doesn't like the League's alliance with the Confederation and pesters her superiors to attack the allied nation while it is weak.

BMB-10D BOMBARDIER

Type: **Bombardier**

Technology Base: Inner Sphere

Tonnage: 65

Battle Value: 1,340

Equipment

		Mass
Internal Structure:		6.5
Engine:	260	13.5
Walking MP:	4	
Running MP:	6	
Jumping MP:	0	
Heat Sinks:	10	0
Gyro:		3
Cockpit:		3
Armor Factor:	200	12.5
	<i>Internal Structure</i>	<i>Armor Value</i>
Head	3	9
Center Torso	21	24
Center Torso (rear)		15
R/L Torso	15	20
R/L Torso (rear)		10
R/L Arm	10	20
R/L Leg	15	26

Weapons

and Ammo	Location	Critical	Tonnage
LRM 20	RT	5	10
Ammo (LRM) 12	RT	2	2
LRM 20	LT	5	10
SRM 4	RA	1	2
Ammo (SRM) 25	RA	1	1
Machine Gun	CT	1	.5
Ammo (MG) 200	CT	1	1

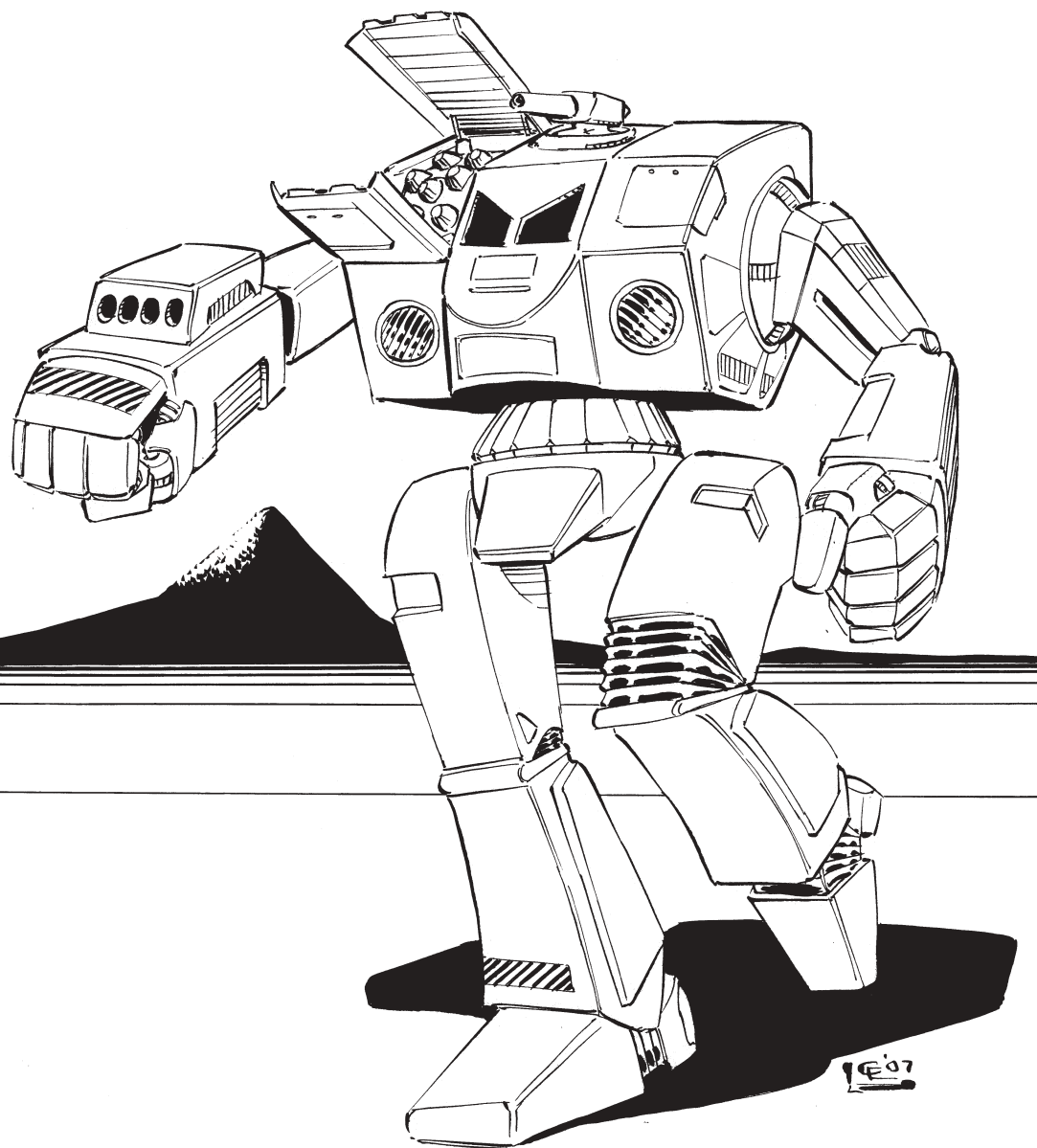

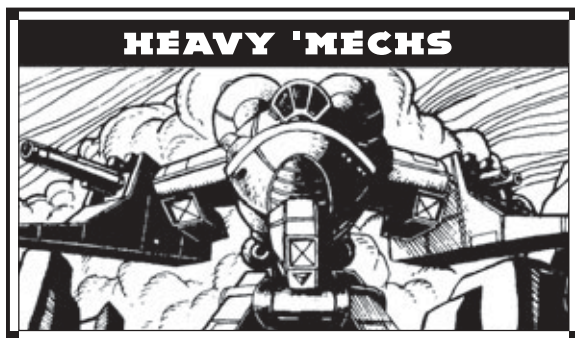

Mass: 70 tons
Chassis: Crucis Type V
Power Plant: VOX 280
Cruising Speed: 43 kph
Maximum Speed: 64 kph
Jump Jets: Anderson 398
Jump Capacity: 120 meters
Armor: Ulston Prime
Armament:
 1 Sunglow Type 2 Large Laser
 4 Exostar II Medium Lasers
 1 Coventry-6 SRM Launcher
Manufacturer: Newhart Industries, Irian
 BattleMechs Unlimited
Primary Factory: New Earth (Newhart, destroyed 2776), Irian (IMBU)
Communications System: Starlink 955G
Targeting and Tracking System: Pulsar Tri-X

Overview

The Terran Hegemony was looking for a heavy shock unit, and in 2499 Newhart Industries delivered with the *Guillotine*. A solid 'Mech, it was the most popular heavy 'Mech in the Hegemony and Star League forces. As time went by and heavier 'Mechs were designed that had more firepower than the *Guillotine*, it transitioned from a line unit to more of a raider or harassment unit. The jump capability also allowed it to be used for specialty units, such as mountain or jungle forces.

The destruction of Newhart's facilities in 2776 as part of a celebration by the Twelfth Republican Guard, The

Minutemen, almost ended the production of new *Guillotines*. Irian continued to manufacture the 'Mech under license for nearly another fifty years, until shortages of advanced materials forced the downgrade of the design—which Irian would produce on and off during the centuries.

Capabilities

The *Guillotine* is an excellent close-combat 'Mech. With twelve tons of armor, it can go toe-to-toe with many assault 'Mechs. Quad medium lasers and a six-tube SRM launcher give it plenty of punch, while the Sunglow large laser gives it some range and a concentrated weapon. However, it is the ability to use all these weapons together that makes the *Guillotine* feared. With twenty-two heat sinks, it can fire all its weapons with minimal heat buildup. For mobility, the *Guillotine* mounts quad Anderson jump jets, allowing it to get behind enemies.

The Sunglow is not without problems. All the *Guillotine's* lasers have the power converter deep in the machine and fiber optic cables to the emitters. This works well for the mediums, but the long cable to the large laser can get tangled when trying to raise the arm above shoulder level. New pilots will panic and push the arm harder, often snapping the fiber optics. The missile system used to have issues as well, with missiles five and six not arming on occasion. The problem was found to be in the ammunition storage bin; when the CASE system was removed the problem went away.

Deployment

Guillotines that have survived from the Star League era are dispersed all over the Inner Sphere. Periphery forces tend to frown upon their use because of the association with the Star League. The 4L variant is found mainly in the Free Worlds League. ComStar has a large stockpile of *Guillotines*, and the machine is popular in the Com Guards as well as the Ghost Regiments of the Combine that were supplied by ComStar.

During the Second Succession War, House Marik raided Capellan worlds, taking water or supplies. What the Capellans didn't know was that the League forces left something: *Guillotines*. The perfect guerrilla raider with little reliance on ammunition, two dozen *Guillotines* started

harassing half a dozen worlds. The 'Mechs would hide in unpopulated areas and appear at random. Their targets were often military support facilities and industries; when Capellans responded, the *Guillotines* would execute a fighting withdrawal. Plagued by these raids, Confederation forces massed to destroy the Marik intruders. With their military tied up, Marik forces successfully captured Ohrensen and Ilmachna—although both would be recaptured at the start of the Third Succession War. A third of the *Guillotines* were later retrieved.

Variants

Few MechWarriors have tried to tamper with success, and the GLT-4L remains the most common variant of the *Guillotine* presently in use. Occasionally, the large laser has been replaced with a PPC, but with mixed results.

The original GLT-3N used a lighter endo-steel exoskeleton, had a CASE system protecting the ammo, and mounted three additional heat sinks.

Notable MechWarriors

Demi-Precentor Christopher Knight: After Knight's performance cutting down a trio of pirates on Poulso, questions arose as to where he got his training and experience. ComStar and Knight both state that he is a recent graduate from Sandhurst. Whatever the case, the locals are happy that he and his unit were available. Federated Commonwealth military representatives, however, remain skeptical.

Captain Sienna Sterling: People who see Captain Sterling off-duty would guess she is a librarian. On duty, no one would mistake the extremely aggressive rising star of the Fourth Regular Hussars for a wallflower. She not only demands excellence from herself and her men, but also from her superiors. While some might regard her attitude as insubordinate, the precision of her company allows her some leeway. Her company prefers to surround an enemy force and use long-range weapons on them while her command lance wades into the midst of their foes.

GLT-4L GUILLOTINE

Type: **Guillotine**

Technology Base: Inner Sphere

Tonnage: 70

Battle Value: 1,400

Equipment

		Mass
Internal Structure:		7
Engine:	280	16
Walking MP:	4	
Running MP:	6	
Jumping MP:	4	
Heat Sinks:	22	12
Gyro:		3
Cockpit:		3
Armor Factor:	192	12
	<i>Internal Structure</i>	<i>Armor Value</i>
Head	3	9
Center Torso	22	27
Center Torso (rear)		12
R/L Torso	15	22
R/L Torso (rear)		8
R/L Arm	11	20
R/L Leg	15	22

Weapons and Ammo

	Location	Critical	Tonnage
Large Laser	LA	2	5
Medium Laser	LT	1	1
SRM 6	CT	2	3
Ammo (SRM) 15	RT	1	1
Medium Laser	RT	1	1
2 Medium Lasers	RA	2	2
Jump Jet	LT	1	1
Jump Jet	LL	1	1
Jump Jet	RT	1	1
Jump Jet	RL	1	1

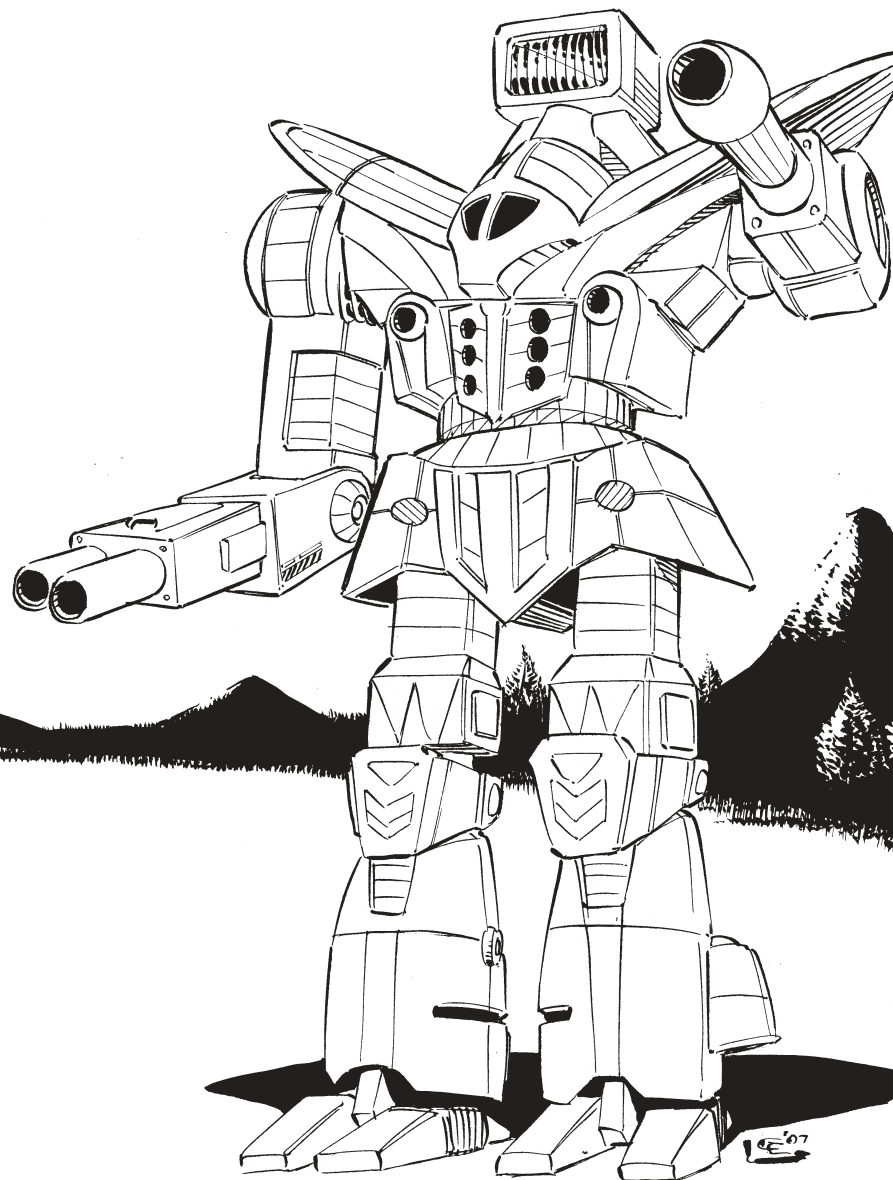

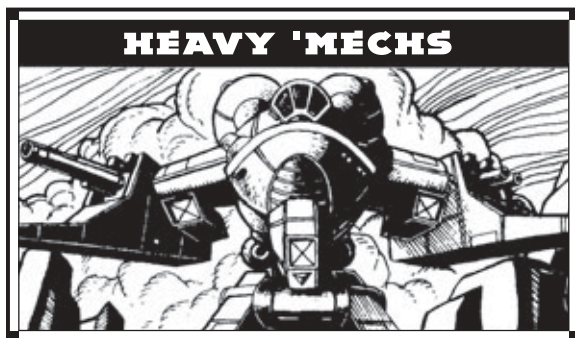

Mass: 75 tons

Chassis: Technicon Standard

Power Plant: Vlar 300

Cruising Speed: 43 kph

Maximum Speed: 64 kph

Jump Jets: None

Jump Capacity: None

Armor: Valiant Lamellor

Armament:

1 Magna Hellstar II PPC

2 Tronel III Large Lasers

4 Tronel II Medium Lasers

1 Tronel I Small Laser

Manufacturer: Kong Interstellar Corporation

Primary Factory: Connaught (destroyed 2820)

Communications System: Tek BattleCom

Targeting and Tracking System: Tek Tru-Trak

Overview

Introduced during the Reunification War, the *Black Knight* proved incredibly successful as both a main line heavy BattleMech, and also command unit. The near-destruction of Kong Interstellar's Connaught factories in 2802 forced KIC to modify their BL-6-KNT to create a variant they could manufacture using available materials. Production restarted in 2809 and continued until the line was finally destroyed by Liao raiders in 2820

Capabilities

The First Succession War was incredibly destructive for the Inner Sphere's industrial and technological base. Now unable to manufacture an endo-steel internal structure,

Kong's engineers reverted to a more primitive (and heavier) frame. Some of the extra three-and-a-half tons this required came from the removal of the sophisticated sensors that made the *Black Knight* such a good command platform. Like the endo-steel, the active probe was no longer available, but the remaining balance was made up through the removal of two tons of armor.

The original *Black Knight* debuted with the Star League's Third Heavy Assault Regiment (the Pythons), where it earned a reputation amongst the League's enemies as a 'Mech that had to be dismembered to be stopped. Even after being "downgraded," the *Black Knight* is a dangerous opponent for contemporary designs. In a one-on-one battle with another heavy BattleMech—assuming equally skilled MechWarriors—conventional wisdom is that the *Black Knight* will always triumph.

If the *Black Knight* has one weakness, it is a tendency to overheat, an issue that even the Star League failed to correct. Armed exclusively with energy weapons, a MechWarrior must exercise strict fire discipline, employing weapon groups appropriate to the range while resisting the urge to "Alpha Strike."

Deployment

With KIC unable to build new *Black Knights*, the design has become increasingly rare. A handful can still be found in the ranks of the Oriente Hussars, but age and a lack of spare parts has compromised their combat readiness.

During the First Succession War, the Successor States refitted many of the BL-6-KNTs that fell into their hands after the fall of the Star League. With modifications performed on an ad-hoc basis, the end result typically resembled Kong's redesign. However, MechWarriors should pay attention when facing a *Black Knight*, for other modifications such as jump jets or non-standard weaponry can catch out the unwary. Few of these Succession War veterans have survived to the present day—the majority are concentrated in the Federated Suns, while the Capellan Confederation currently possesses none.

Interestingly, ComStar only provided the Draconis Combine with a handful of *Black Knights*, and the few that Kurita received appeared to have been the result of a clerical error.

Variants

Due to the scarcity of PPCs in the Free Worlds League, one field modification replaces a damaged PPC with a third large laser and two heat sinks.

Notable MechWarriors

Captain Ian McKinnon: Commander of the elite Fox's Teeth, Ian McKinnon has earned a reputation as a daring, almost reckless leader. Given McKinnon's flair for independent operations, his superiors have long since resigned themselves to his habit of interpreting orders somewhat loosely. A master of unconventional tactics, Ian has out-thought and outfought the best the Draconis Combine and Capellan Confederation have to offer.

Ian's *Black Knight* is a relic from the fall of the Star League. Originally a BL-6-KNT, generations of battle damage and repairs have removed its advanced equipment. As his father's 'Mech, it was heavily damaged in 3020 at the battle of Harrow's Sun. Restored to operational condition after the Fourth Succession War, the *Black Knight* has since been refitted with experimental equipment from the New Avalon Institute of Science.

Colonel Mordon Greenburg: After serving ten years in the Marik Militia, Greenburg left military service and made a name for himself as a combat correspondent, and his coverage of the final years of the Third Succession War made him a household name across the Inner Sphere. In 3027 Greenburg approached his Tharkad Broadcast Company producer with an idea for a documentary series covering the day-to-day lives of a mercenary unit. Thus was born a successful holo vid show known as "Greenburg's Godzillas." When network executives canned the show at the outbreak of the Fourth Succession War, Mordon Greenburg chose to remain with the "cast."

Exotic by nature of its rarity, Greenburg's *Black Knight* is the perfect ride for a holo vid star. A relic of his ten years service in the Twenty-third Marik Militia, studio backing restored the 'Mech to its current good condition.

BL-7-KNT BLACK KNIGHT

Type: **Black Knight**

Technology Base: Inner Sphere

Tonnage: 75

Battle Value: 1,443

Equipment

Internal Structure:

Engine: 300

Walking MP: 4

Running MP: 6

Jumping MP: 0

Heat Sinks: 20

Gyro: 3

Cockpit: 3

Armor Factor: 176

Mass

7.5

19

10

3

3

11

	Internal Structure	Armor Value
--	--------------------	-------------

Head	3	9
------	---	---

Center Torso	23	25
--------------	----	----

Center Torso (rear)		8
---------------------	--	---

R/L Torso	16	20
-----------	----	----

R/L Torso (rear)		7
------------------	--	---

R/L Arm	12	20
---------	----	----

R/L Leg	16	20
---------	----	----

Weapons

and Ammo

	Location	Critical	Tonnage
PPC	RA	3	7
Large Laser	RT	2	5
Large Laser	LT	2	5
Medium Laser	RT	1	1
Medium Laser	LT	1	1
Medium Laser	RA	1	1
Medium Laser	LA	1	1
Small Laser	H	1	.5

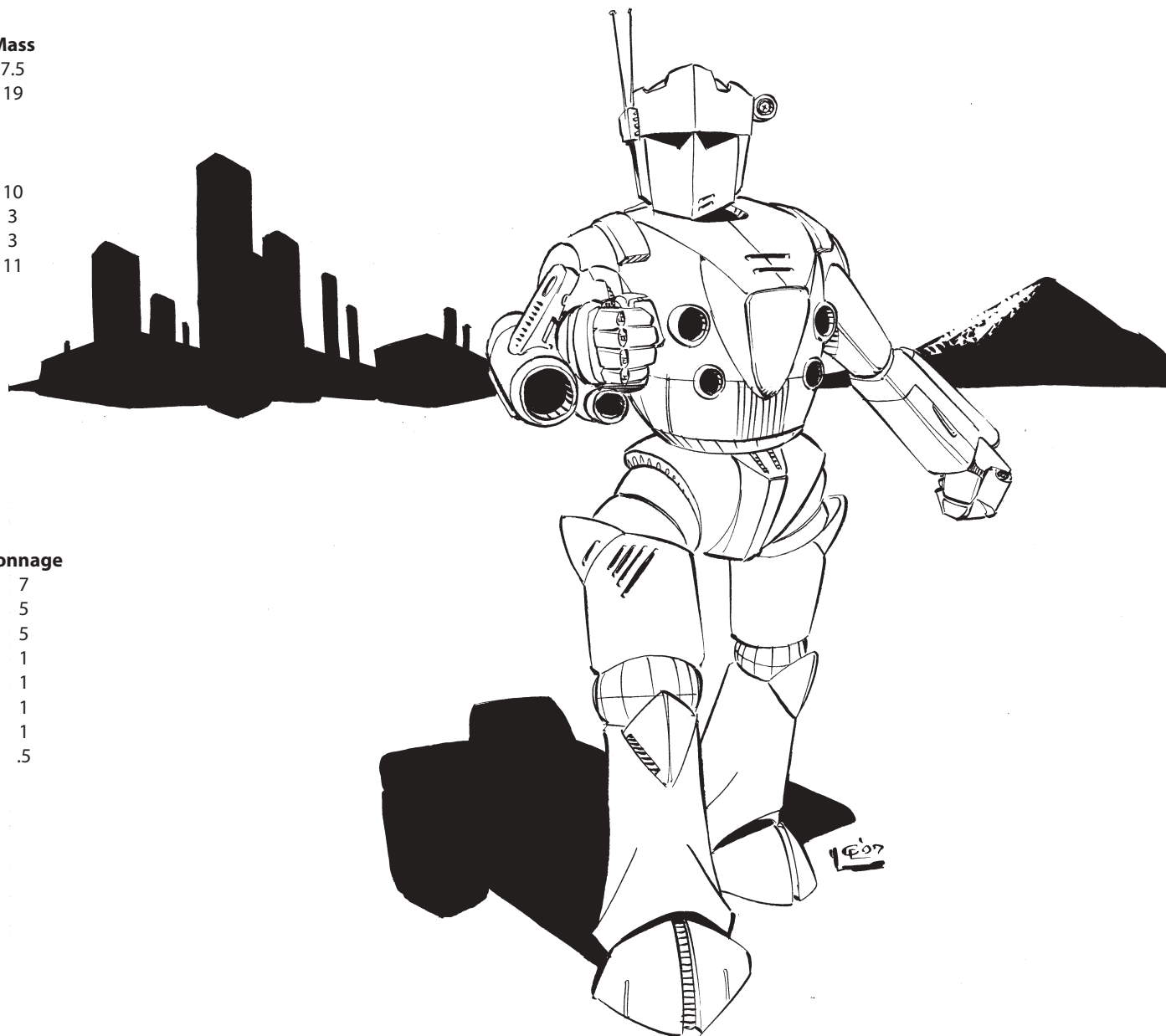

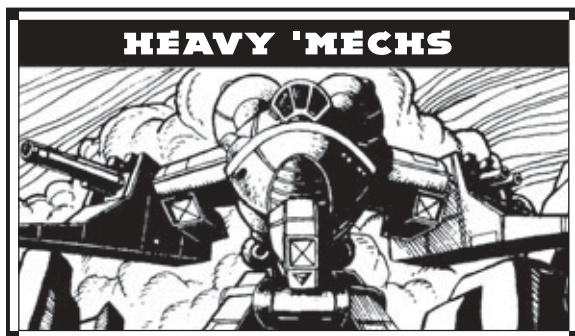

Mass: 75 tons

Chassis: FLS/HV-1

Power Plant: Vlar 300

Cruising Speed: 43 kph

Maximum Speed: 64 kph

Jump Jets: None

Jump Capacity: None

Armor: Kemplar 5000

Armament:

2 Thunderbolt A5M Large Lasers

5 Defiance B3M Medium Lasers

1 Coventry Volcano Flamer

Manufacturer: Defiance Industries

Primary Factory: Hesperus II

Communications System: Faust/Calliope FM-4

Targeting and Tracking System: TharHes Ares-7

Overview

The *Flashman* debuted in 2701, with the first battalions forming the core of heavy and battle regiments throughout the Hegemony. By the fall of the Star League, several of the League's BattleMech divisions had formed fast brigades composed of *Flashman* battalions, and the strength and flexibility of the design meant that it remained popular after the Exodus through the First Succession War. Unfortunately for the *Flashman*, the destruction of Renault-Prime's manufacturing facilities on Wasat in 2796 and the brutality of the First Succession War meant it nearly became extinct. It was only the lucky acquisition of a schematics package by Defiance Industries that saved the *Flashman* from history, although its numbers never climbed to their pre-Exodus zenith.

Capabilities

The original *Flashman* was designed as a powerful cavalry 'Mech with the speed to move quickly and the firepower to make a difference when it arrived on the scene. Although the decline of technology in the orgy of destruction that was the First Succession War meant that the *Flashman's* advanced engine could no longer be maintained, a simple redesign allowed the *Flashman* to use the popular Vlar 300 fusion engine, giving it speed comparable to other heavy BattleMechs.

Offensively the *Flashman* isn't, pardon the phrasing, terribly flashy. What it is, however, is reliably dangerous. A pair of Thunderbolt A5M large lasers are mounted in the *Flashman's* forearms. Potent as they are, the Thunderbolts are not the *Flashman's* primary weapons. This distinction is claimed by the battery of five Defiance B3M medium lasers. Although individually less powerful than the larger Thunderbolt lasers, the Defiance B3M lasers demonstrate strength in numbers, consistently delivering more damage than the bigger weapons. Finally, an anti-personnel flamer gives the *Flashman* both a strong and psychological defense against swarming infantry.

Although the technological degradation of the Succession Wars has robbed the *Flashman* of its speed, it is still well endowed with thirteen-and-a-half tons of armor and a mammoth complement of twenty-three heat sinks. Though this seems like a massive load of heat dispersal, the laser weaponry of the *Flashman* generates incredible amounts of heat, making even this staggering array somewhat weak.

Deployment

The collapse of the Star League spread the *Flashman* to every Successor State, but with the only production facility sitting in Lyran space, the Commonwealth was the only nation to even attempt to replace combat losses. The *Flashman's* small logistical tail appealed to the merchant bent of the Lyran nation, and the heavy 'Mech was kept in almost-constant, even if not prodigious, production since Defiance's first chassis walked off the assembly line. The *Flashman* is popular in Lyran heavy lances, where it supports more classically Lyran machines like the *Zeus* and *Crusader*.

Variants

The *Flashman* does not lend itself easily to variants. Battle damage is often repaired with off-brand equipment, but technicians take great pains to find materials of the same class. While there certainly exist *Flashman* 'Mechs with Victory lasers or a Hotshot flamer, the basic capabilities remain unchanged.

Notable MechWarriors

Hauptmann Ivar Karsgaard: Hauptmann Karsgaard led the Lightning Company of the Third Donegal Guards during the Fourth Succession War from the cockpit of his *Flashman*, the "Lightstorm." At one point, Karsgaard and Lightstorm were responsible for six kills in one skirmish. Karsgaard and his command lance, a pair of *Crusaders* and a *Hunchback*, worked as a unit to drive enemy 'Mechs in a kill-basket that was nearly inescapable. The *Crusaders* fired salvos of long-range missiles that drove the target to close with them, where Lightstorm and the *Hunchback* could demolish the victim's armor at close range. After the war, Karsgaard was transferred to the Blackjack School of Combat, where he's been teaching the cadets tactics and ambush strategies since. He was disciplined four times during the War of 3039, the last time for striking the school's commandant for refusing to transfer him back to a combat unit for the duration of the conflict against the Draconis Combine.

Lightning Larry Withers: Lightning Larry was an up-and-coming contender on the Open Circuit fights on Solaris VII during the 3030s. His *Flashman* is a much-repaired and jury-rigged Second Succession War chassis purchased by White Star Stables for a song in 3032. Lightning Larry likes to sneak up on his opponents and strike first with his flamer. He uses the brilliant plasma discharges and any incidental smoke to distract his opponent—and the crowd—from the damage his lasers are doing at knife-fighting range.

FLS-7K FLASHMAN

Type: **Flashman**

Technology Base: Inner Sphere

Tonnage: 75 tons

Battle Value: 1,467

Equipment

		Mass
Internal Structure:		7.5
Engine:	300	19
Walking MP:	4	
Running MP:	6	
Jumping MP:	0	
Heat Sinks:	23	13
Gyro:		3
Cockpit:		3
Armor Factor:	216	13.5

	Internal Structure	Armor Value
Head	3	9
Center Torso	23	25
Center Torso (rear)		16
R/L Torso	16	22
R/L Torso (rear)		10
R/L Arm	12	24
R/L Leg	16	27

Weapons and Ammo

	Location	Critical	Tonnage
Large Laser	RA	2	5
Medium Laser	RA	1	1
Medium Laser	RT	1	1
Flamer	H	1	1
Medium Laser	LT	1	1
Medium Laser	LT (R)	1	1
Medium Laser	LA	1	1
Large Laser	LA	2	5

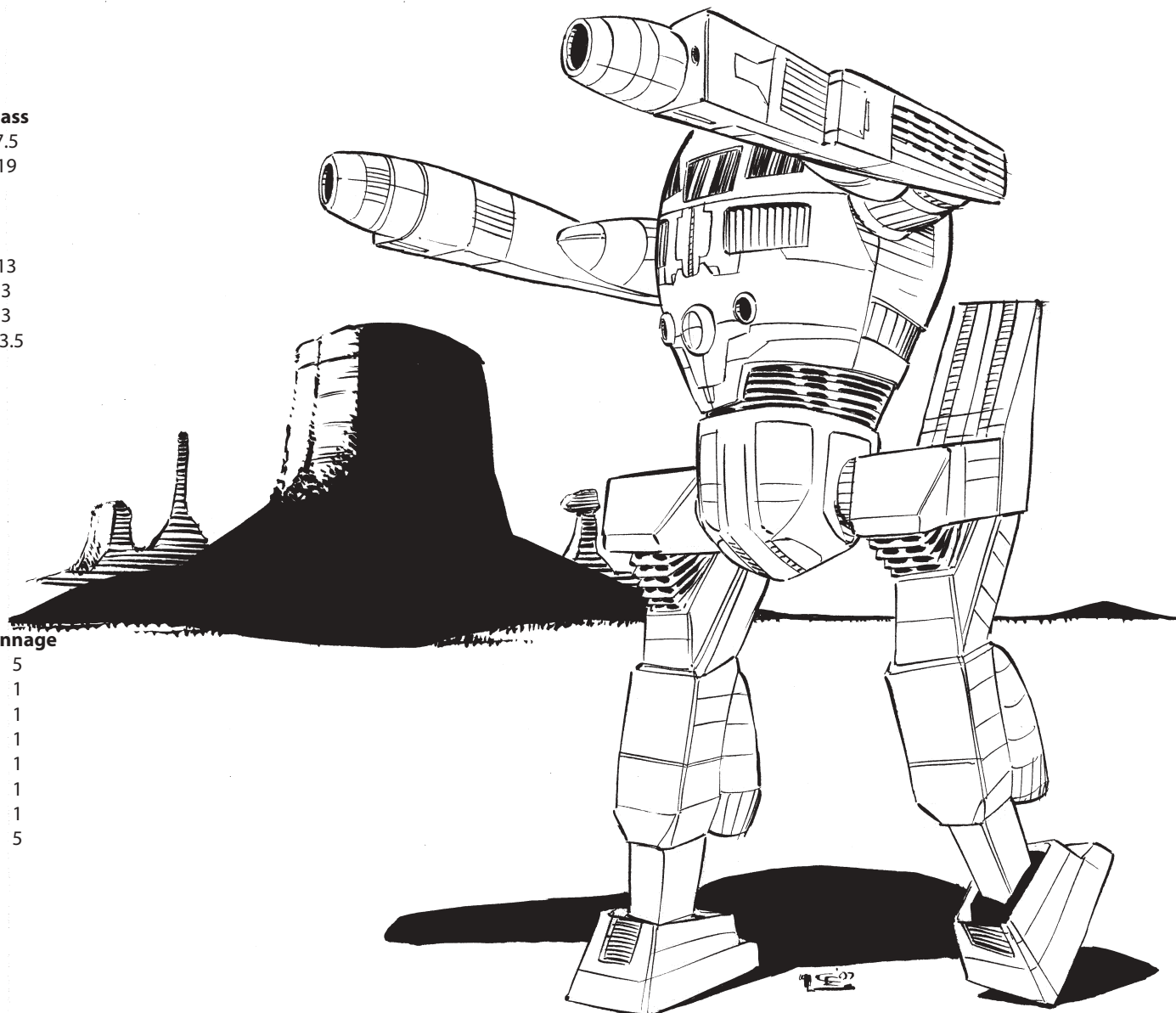

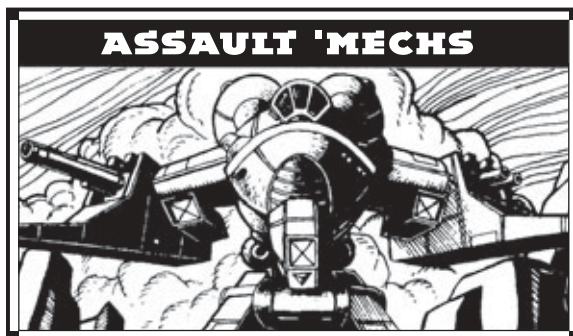

Mass: 80 tons

Chassis: Earthwerks VOL

Power Plant: Pitban 320

Cruising Speed: 43 kph

Maximum Speed: 64 kph

Jump Jets: None

Jump Capacity: None

Armor: Durallex Heavy Special

Armament:

2 Donal PPCs

2 Holly Short-Range Missile 4 Racks

Manufacturer: Earthwerks Incorporated

Primary Factory: Keystone

Communications System: Colmax-025

Targeting and Tracking System: Instatrac Mark XV

Overview

Originally created exclusively for the Star League Defense Force, the *Thug* was designed by the Maltex Corporation to compete with and replace the aging *Warhammer*. Designers attempted to retain the strongest points of the older machine while avoiding its pitfalls. It was well received when unveiled in 2572, and to keep up with demand, Maltex licensed Earthwerks Inc. to run a separate production line.

Capabilities

Since it was intended to be a replacement for the *Warhammer*, the *Thug* has very similar weapons and capabilities. A pair of particle projection cannons cooled by nineteen heat sinks allows the design to remain relatively cool while bombarding the enemy from range. When enemies

attempt to close underneath the cannons' minimum range, the design retaliates with a pair of Holly SRM 4 racks. The *Thug's* devastating physical attacks make it even more fearsome. The one drawback of this configuration is that the secondary weapons are ammunition based, and if a lucky blow hits the bays, the BattleMech would at best be crippled. [EDITOR'S NOTE: The original 11E had more advanced ammunition bays, vastly safer than the standard ones seen up until the Clan Invasion.]

The largest selling points for a *Thug*, even a downgraded one, was that it carried almost fifty percent more armor than the *Warhammer* and had operating hand actuators, a feature that iconic frontline BattleMechs like the *Warhammer* and *Marauder* lacked. For units designed for raiding, which would become an absolute necessity during the latter half of the Succession Wars, these were more important than anything else to 'Mechs assigned to such missions.

Deployment

The *Thug*, despite being formidable, was never able to replace the *Warhammer*. The Succession Wars destroyed Maltex's single production line, leaving Earthwerks' Keystone line to produce about a dozen *Thugs* a year until the technological renaissance would allow the line to go back to the original 11E variant.

Ironically, it was the *Warhammer* that allowed the *Thug* to survive the Succession Wars. The original Tiegart PPCs were no longer available for the *Thug*, so Earthwerks began extensively modifying the design to utilize the massive *Warhammer* spare part stockpiles. Once these field refits could be done successfully, Earthwerks retooled their line to produce the new assault machines with Donal PPCs, which sustained *Thug* production and enabled existing machines to be repaired and rebuilt more easily.

Elements of Hansen's Roughriders raided Delacruz in 3038 when the mercenary unit was loaned out to the Federated Suns side of the newly formed Commonwealth. The mission started off badly when one of their MechWarriors deserted to have a duel with a MechWarrior from the famous Sorenson's Sabres and subsequently lost her life. However, the Roughriders had a pair of *Thugs*, and these two 'Mechs were credited with single-handedly holding off an entire company of

defending Kurita units while the rest of the raiders emptied a supply warehouse of spare parts and ammunition. The Roughriders razed the facility and successfully retreated off-world.

Variants

Unwilling to tamper with success, Earthwerks produced no variants of the 10E *Thug* until well after the War of 3039.

Notable MechWarriors

Busosenshi Kari Kakashi: A member of the Eleventh Ghost Regiment, Kakashi saw heavy fighting on Matar during the War of 3039. While on the defensive in the tri-cities, Kakashi became isolated during a push by the First Kestrel Grenadiers to take the urban sprawl. Moving block by block, avoiding enemy units as best she could, her *Thug's* armor was slowly whittled away by the occasional enemy stumbling into her line of fire. Her armor stripped, missile bays empty, and running hot, Kakashi believed herself dead when surrounded by a lance of relatively fresh heavy BattleMechs. Fortunately, her company mates made a last minute intervention with their Star League-era *Highlanders*, leaping out from behind buildings and landing on two of her attackers, crushing them immediately. As the other two Grenadiers withdrew, they found their retreat cut off by other *Thugs* and *King Crabs*. This chase and rescue would later be considered the offensive push that led to the First Grenadiers pulling out of the city. Now *Chu-i*, Kakashi believes she would not have made it out alive if she had been in any other class of BattleMech.

MechWarrior Sonnie Berkinshire: A member of the Third Ceti Hussars, Berkinshire was able to salvage a Kuritan *Thug* during the fighting on Rochester. He is still rebuilding it, using whatever experimental advanced technologies he can acquire in an attempt to recreate the Star League-era version.

THG-10E THUG

Type: **Thug**

Technology Base: Inner Sphere

Tonnage: 80

Battle Value: 1,501

Equipment

		Mass
Internal Structure:		8
Engine:	320	22.5
Walking MP:	4	
Running MP:	6	
Jumping MP:	0	
Heat Sinks:	19	9
Gyro:		4
Cockpit:		3
Armor Factor:	232	14.5

	Internal Structure	Armor Value
Head	3	9
Center Torso	25	33
Center Torso (rear)		10
R/L Torso	17	24
R/L Torso (rear)		8
R/L Arm	13	25
R/L Leg	17	33

Weapons and Ammo

	Location	Critical	Tonnage
PPC	RA	3	7
PPC	LA	3	7
SRM 4	RT	1	2
SRM 4	LT	1	2
Ammo (SRM) 25	RT	1	1

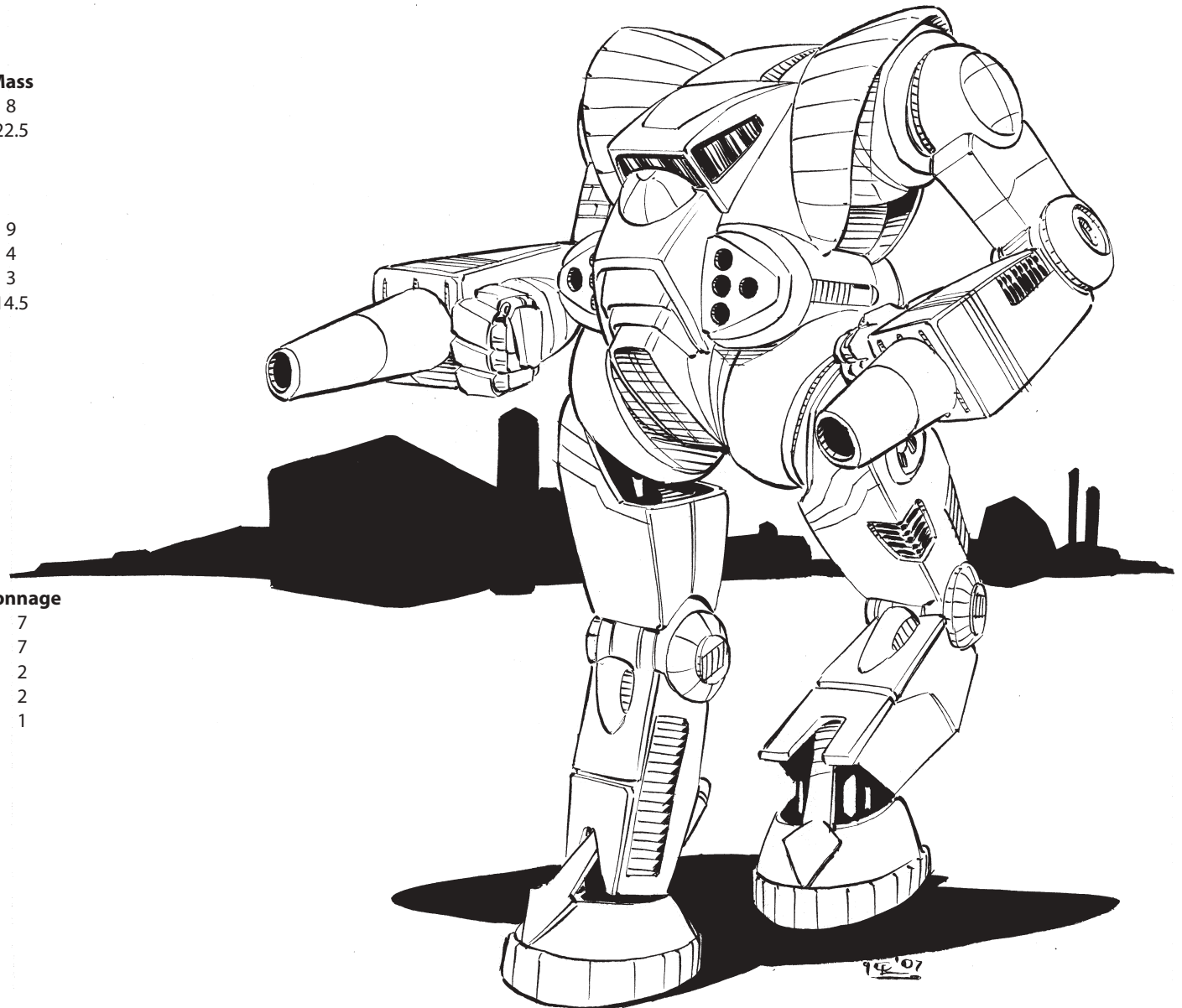

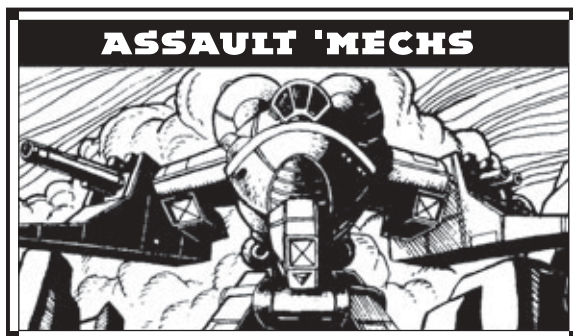

Mass: 90 tons

Chassis: Hollis-HGN

Power Plant: GM 270

Cruising Speed: 32 kph

Maximum Speed: 54 kph

Jump Jets: HildCo Model 10

Jump Capacity: 90 meters

Armor: Lang Composite

Armament:

- 1 Mydron Class B Heavy Autocannon
- 1 Holly Long-Range Missile 20 Rack
- 1 Holly Short-Range Missile 6 Rack
- 2 Martell Medium Lasers

Manufacturer: StarCorps Industries

Primary Factory: Son Hoa (refits only)

Communications System: Hartford Com/A-7

Targeting and Tracking System: Hartford Hypertrak/Q-45

Overview

Designed for the Star League Defense Force in 2592, the *Highlander* was an instant success with both the Regular and Royal regiments, as its wide variety of weapons and jump jets could take on any situation. However, the Succession Wars devastated the factory on Son Hoa, leading to the virtual extinction of the design toward the end of the Second Succession War. Hollis Incorporated suggested a licensing proposal to StarCorps involving rebuilding destroyed chassis almost from scratch while using readily available technologies. StarCorps readily accepted the proposal—and a hefty licensing fee.

Hollis continued to custom-build the 733 models until the Fourth Succession War, when its license was revoked. With the capture of the Corey production line and the discovery of the Helm Memory Core, StarCorps was able to begin producing 733 refits on Son Hoa by the mid 3030s. [EDITOR'S NOTE: StarCorps was eventually able to restart full *Highlander* production on Son Hoa in 3057.]

Capabilities

Unlike other Star League-era designs such as the *Devastator* and the *Exterminator*, the *Highlander* did not suffer too badly when it was retooled to carry more primitive technologies. It retained almost the same amount of protection, and its main weapon—the Mydron Heavy Autocannon—is still deemed sufficient as a primary gun, especially when paired with its LRM 20 rack for long-range exchanges. For shorter-ranged engagements, an SRM 6 and a pair of medium lasers can scare anything but heavier opponents; when combined with the autocannon, even heavier opponents are wary of a brute exchange of fire with a *Highlander*. Many compare this favorably with the iconic *Atlas*, which, while ten tons heavier, only mounts moderately more firepower and slightly more armor. Some prefer the lighter 'Mech, as it has more endurance with its sizeable ammunition bay, and pilots sometimes claim it has more mobility and better range. The few MechWarriors possessing a functional *Highlander* did whatever they could to keep their assault 'Mech in working condition, even if it meant going to the black market for spare parts.

What makes the *Highlander* stand out among its peers is that it was the heaviest design at the time to incorporate jump jets, leading many MechWarriors to perform physical attacks by literally leaping onto their targets and landing on their shoulders, or more fatally, their cockpit. This death from above attack was eventually nicknamed the "Highlander Burial" (because the foe could be driven into the ground). The Highlander Burial was so popular with pilots that StarCorps had to redesign the leg section, reinforcing it with more armor and supports. When Hollis approached StarCorps to rebuild the stripped-down versions, the license was granted on the contingency that the jump jets be kept in the redesign.

Deployment

Both the Capellan Confederation and the Lyran Commonwealth use the *Highlander* in small numbers, as the production lines only churned out less than a dozen a year in either facility. It was with great surprise, then, when during the War of 3039 the Draconis Combine fielded 733 *Highlanders* in moderate numbers alongside smaller amounts of the original 732 models. Provided by ComStar and accompanied by another rarely seen assault design, the *Thug*, their mere appearance caused the morale of Lyran soldiers to plummet when Kuritan lines weathered salvos as well as a Lyran line of battle.

The BattleMech itself was often positioned as an installation defender, and later on it joined mobile-fire lances that needed jump capability over raw firepower. However, such lances, which included *Grasshoppers*, *Victors*, and *Exterminators*, were quite apt at breaking enemy lines when needed.

Variants

Somewhat limited by the terms of their license, Hollis never produced any official variants. Occasionally, the Mydron would be replaced with a heavier autocannon or a PPC and extra heat sinks.

Notable MechWarriors

Tai-i Barry Corman: Commander of an assault company within the Eleventh Ghost, Corman runs a mix of *Highlanders*, *King Crabs*, and *Thugs* designed to slug it out with heavy Lyran troops. However, during the War of 3039, the company found themselves fighting Davion troops within the tri-cities on Matar. Corman's company held onto one section of the city while the First Kestrel Grenadiers attempted several times to push the Eleventh Ghost out. The *Thugs* and *King Crabs* eventually pushed into the Grenadiers' lines, finding pockets of Davion troops and holding them in place while the *Highlanders* leaped out from behind buildings and performed Highlander Burials on the pinned units. *Tai-i* Corman was credited with three BattleMech kills, all by death from above attacks, before the First retreated out of the urban sprawl.

HGN-733 HIGHLANDER

Type: **Highlander**

Technology Base: Inner Sphere

Tonnage: 90

Battle Value: 1,801

Equipment

Internal Structure:

Engine: 270

Walking MP: 3

Running MP: 5

Jumping MP: 3

Heat Sinks: 13

Gyro: 3

Cockpit: 3

Armor Factor: 280

Mass

9

14.5

3

3

3

17.5

	Internal Structure	Armor Value
--	--------------------	-------------

Head	3	9
------	---	---

Center Torso	29	41
--------------	----	----

Center Torso (rear)		17
---------------------	--	----

R/L Torso	19	28
-----------	----	----

R/L Torso (rear)		10
------------------	--	----

R/L Arm	15	30
---------	----	----

R/L Leg	19	38
---------	----	----

Weapons

and Ammo

	Location	Critical	Tonnage
AC/10	RA	7	12
Ammo (AC) 20	RT	2	2
LRM 20	LT	5	10
Ammo (LRM) 18	LT	3	3
SRM 6	LA	2	3
Ammo (SRM) 30	LT	2	2
2 Medium Lasers	RT	2	2
Jump Jet	CT	1	2
Jump Jet	LT	1	2
Jump Jet	RT	1	2

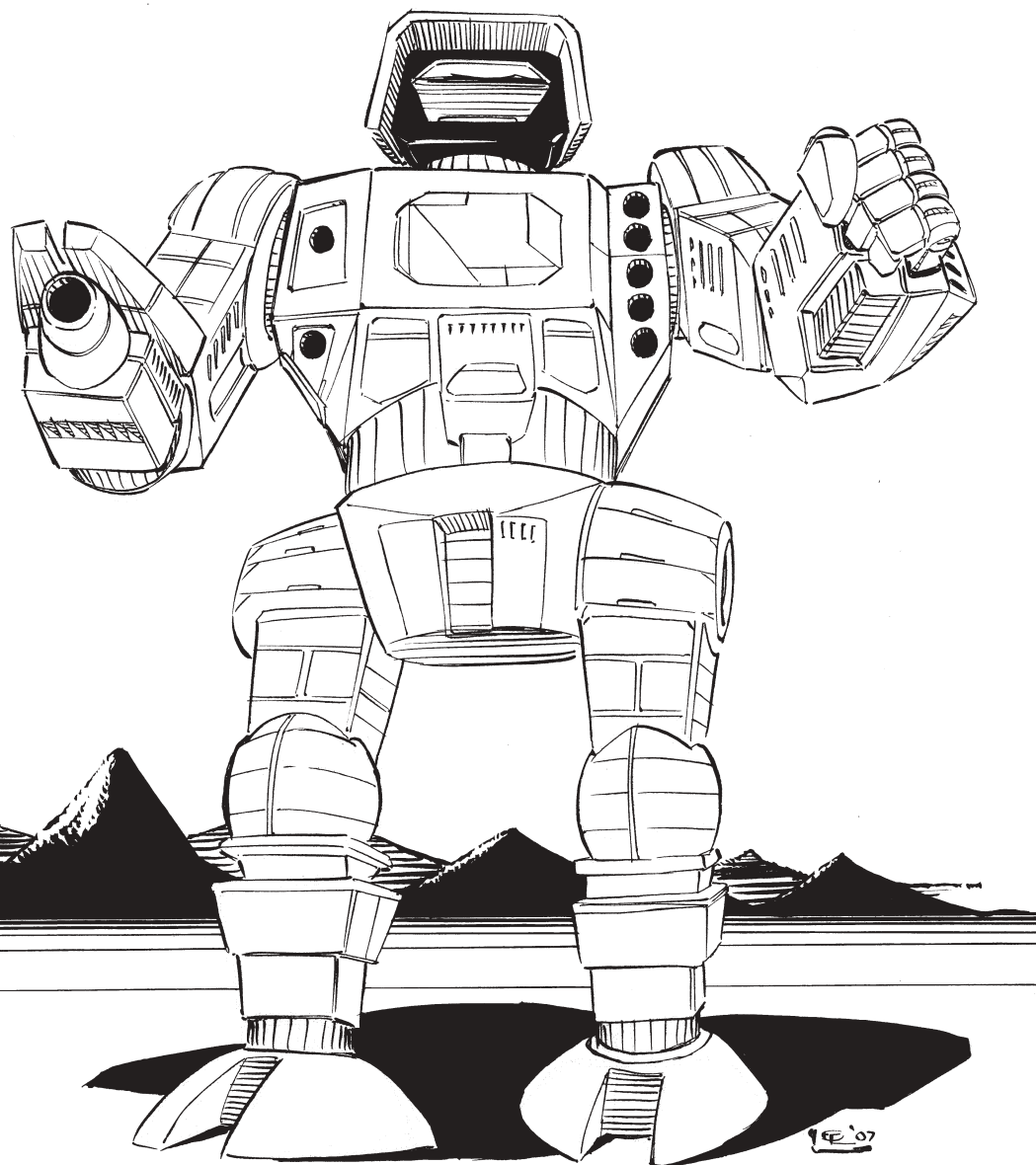

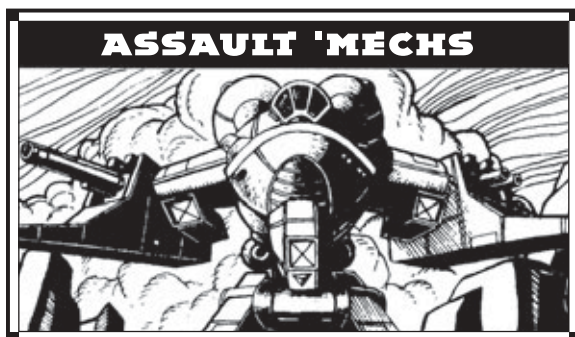

Mass: 100 tons

Chassis: Hollis Mark II

Power Plant: Vlar 300

Cruising Speed: 32 kph

Maximum Speed: 54 kph

Jump Jets: None

Jump Capacity: None

Armor: Valiant Lamellor

Armament:

2 Emperor-D Autocannons

1 Doombud Long-Range Missile 15 Rack

1 Magna Mark III Heavy Laser

Manufacturer: Cosara Weaponries

Primary Factory: Mars (destroyed 2767),
Northwind (destroyed 2786)

Communications System: Dalban VirtuTalk

Targeting and Tracking System: Dalban Hi-Rez

Overview

Introduced near the end of the Star League, the *King Crab* fulfilled General Kerensky's order for an assault 'Mech able to cripple or destroy another BattleMech in one salvo. Though not sporting as much armor as other assault 'Mechs, the firepower mounted by the original *King Crab* and its successors admirably fulfills the role for which the 'Mech was designed.

Capabilities

The KGC-0000's role is quite simple: crush any opposition that stands in the way. Its primary weapon systems are two Emperor-D super-heavy autocannons that

make fulfilling its role very easy. The combined damage output from these two cannons alone is enough to strip the armor from even the sturdiest 'Mech designs after a couple of exchanges.

Because the autocannons are mounted in the reinforced arms, the designers also included claw-like protective housings for the weapon barrels. The covers actually open and close in combat, an effect that gives them the appearance of pincers or claws, a characteristic for which the 'Mech is known—and named.

The main drawback to such a heavy-hitting design is the lack of ammo storage capacity for extended operations. While the KGC-0000 mounts the reliable Magna Mark III heavy laser, it is small comfort to a pilot who hears the last of his ammunition being loaded in the middle of a protracted firefight.

Because the KGC-000 *King Crabs* only sport advanced technology in their armor—unlike the *Highlander*, *Crockett* or *Thug*—they were more easily repaired with Succession Wars-era technology. Conversely, they remained at the forefront of most battles and received a larger ratio of destruction. Only a handful of *King Crabs* remained operational by the end of the Third Succession War.

Deployment

Cosara's main factory on Northwind was destroyed early in the First Succession War and the Cosara-Mars facility was repaired and mothballed on the orders of Jerome Blake. In the early 31st century the company was charged with redeveloping the design in order to reinforce ComStar's secret stockpile, which was suffering some minor attrition due to centuries of storage.

Most *King Crabs* initially produced went with General Kerensky in the Exodus, including the entire prototype run of KGC-010s. No -010s are known to exist anywhere in the Inner Sphere.

Variants

The rare KGC-010 variant was developed alongside the initial -000 production run but utilized a prototype PPC being developed by Hellstar Magna. These PPCs did not require an outer "barrel," instead mounting flush with the torso. Cooling sleeves were mounted to the rear of the

weapon, extending out the back of the 'Mech and presenting the appearance of spines. Surrounding the PPC's opening was a specially designed Holly SRM 6 system; the overall pairing of the two weapons gave the -010 the appearance of a new weapon.

The KGC-010 also mounted LB-10X cluster cannons in each arm. With ammunition spread out in the CASE-protected torso and the use of high-efficiency heat sinks, this prototype *King Crab* delivered a shock in close combat. Combined with the massive heat diffusion waves emanating behind it from the cooling vanes and the odd color of the PPC's weapon discharge, the KGC-010 was a true terror to behold during its brief deployment.

Intrigued by the initial success of the model, Kerensky ordered all -010 designs to be placed among the Exodus materials. The design specs were lost during the subsequent Succession Wars; even knowledge of its existence is only relatively recent.

Notable MechWarriors

Lisa Buhallin: An unconfirmed member of the Blackhearts—the Star League's Special Armed Services counterespionage and counterterrorism corps—Lisa Buhallin was instrumental in disrupting Amaris forces during his occupation of Terra. A former scholar at Sandhurst military academy, she put her intimate knowledge of Europe and Central Asia to use in assisting rebel forces against the Amaris Dragoons. She was a quick study and piloted one of several KGC-010 prototypes liberated from a GM design facility. Lisa accepted an invitation given to her and her comrades by General Kerensky to join him on his Exodus from the Inner Sphere.

Corinth Brody: President of the Nightwatch security company, Brody is one of the few independent owners still in possession of a rare KGC-000 *King Crab*. Its origins remain a mystery; it is rumored by other members of the firm that Brody's grandfather actually struck it rich lostech prospecting on Caph during the Third Succession War. The Nightwatch usually hire out only as corporate security; the unit has been under contract to Sekkaris Metalworks on Terra since 3038.

KGC-0000 KING CRAB

Type: **King Crab**

Technology Base: Inner Sphere

Tonnage: 100

Battle Value: 1,810

Equipment

		Mass
Internal Structure:		10
Engine:	300	19
Walking MP:	3	
Running MP:	5	
Jumping MP:	0	
Heat Sinks:	15	5
Gyro:		3
Cockpit:		3
Armor Factor:	272	17

	Internal Structure	Armor Value
Head	3	9
Center Torso	31	39
Center Torso (rear)		12
R/L Torso	21	29
R/L Torso (rear)		10
R/L Arm	17	33
R/L Leg	21	34

Weapons

and Ammo

	Location	Critical	Tonnage
AC/20	LT/LA	10	14
Ammo (AC) 5	LT	1	1
AC/20	RT/RA	10	14
Ammo (AC) 5	RT	1	1
LRM 15	LT	3	7
Ammo (LRM) 8	LT	1	1
Large Laser	RT	2	5

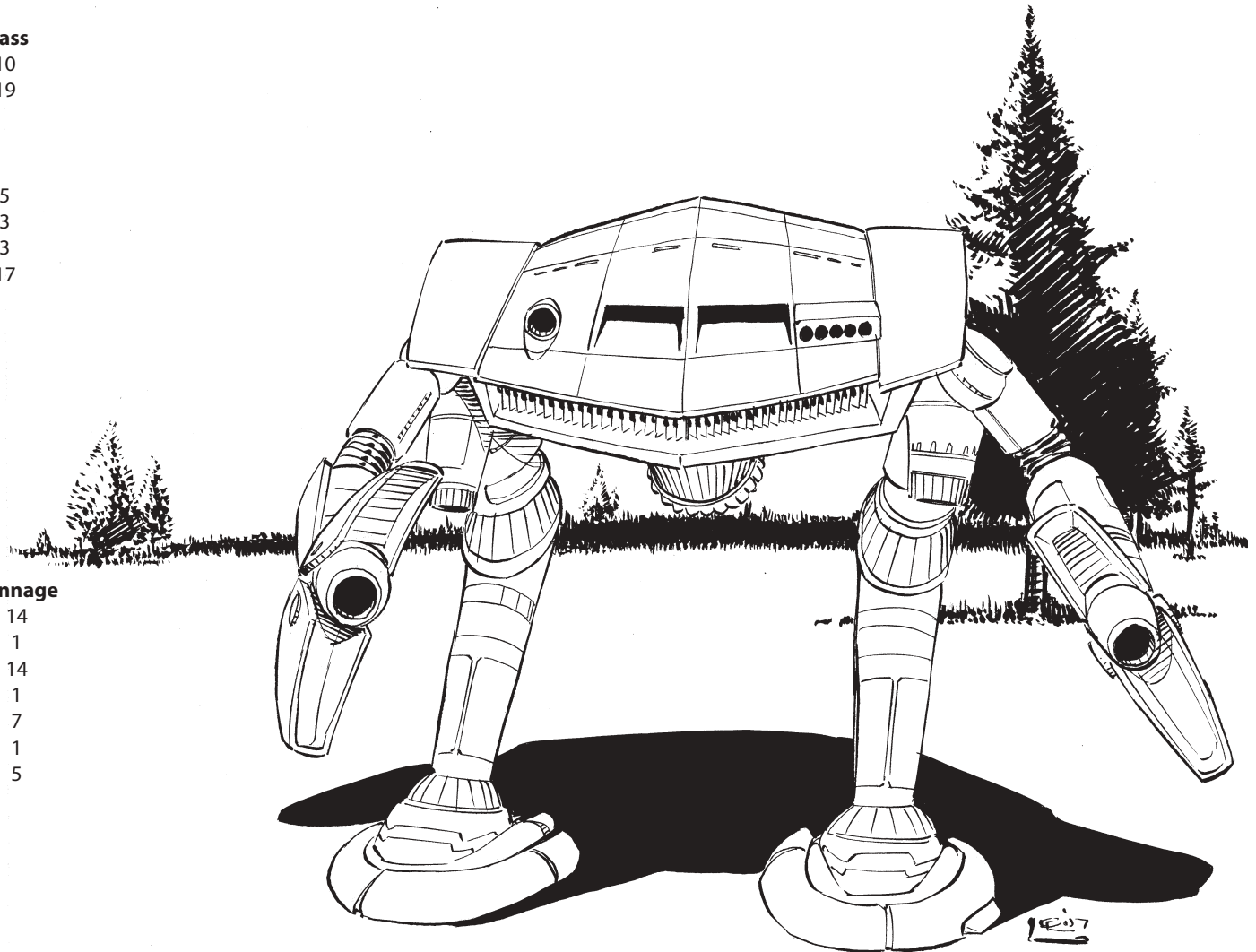

PROJECT PHOENIX

When General Trevena first delivered his manuscript, the BattleMechs found within this section were organized with the rest of the 'Mechs from section three. However, I've taken the liberty of slightly re-organizing this document, as I believe it is important to present the following machines in their own section. I hope the General does not mind my temerity.

The chicken or the egg—which came first? A philosophical debate begun with the ancients. But the trite question is once more relevant in this case. Giovanni Estrella De la Sangre. Word of Blake. Which came first? Or, as so many believe—including myself—are they intrinsically linked? With the Jihad raging, we cannot know. Perhaps when the fires burn down we can sift through the ashes.

Regardless of the connections or who holds ultimate responsibility for its genesis, in the 3060s Giovanni used Vicore Industries to promote a bold, new concept: Project Phoenix. As the FedCom Civil War raged across a thousand light years and hundreds of worlds (as well as numerous other large-scale border disputes), the desire for war materials was insatiable. While the giants of IrTech, DefHes, and others continued to pioneer new designs, the demand usually outstripped production.

The plan was simple in concept. The seed was planted on the world of Outreach. Prince Hanse Davion and Captain-General Thomas Marik sealed a deal for the Free Worlds League to provide field upgrade kits during the Clan Invasion; bundles of new technology supplied by House Marik to troops from other Houses on the Clan front, material that could be fitted onto a design in the field without the need for a full production facility. While such kits were astoundingly successful (the concept remains in use today), the bold, new Project Phoenix concept took it a step further. Take an ancient machine from the field and refurbish it from the ground up, incorporating the latest technologies.

That process, obviously, isn't something new—it's been done for millennia, as this often is a cheaper route to technological relevance (something bean counters love to hear). Yet the unlocking of the Helm Memory Core created a culture of techno-lust that allowed Giovanni's marketing brilliance to come to the fore. He took the time to re-cast the image of these ancient 'Mechs, re-working armor and weaponry placement. The powerful designs, with their heavily modified silhouettes, satiated both the demand for more war materials and the "only the newest will do" mentality.

Giovanni became a one-man snake-oil salesman, traveling the Inner Sphere and hawking the concept repeatedly to numerous factories. Demonstrating his marketing prowess, he first struck the smaller 'Mech manufacturers, giving them a leg up on the true interstellar corporations. With that momentum he then approached those same giants and began making sales as well.

Now what does all this have to do with 3039, a time decades before this transformation began? For a student of history, these designs are crucial, as they've formed the backbone of most House militaries for centuries. However, a modern-day soldier will more often than not find a Project Phoenix 'Mech marching towards him across the battlefield. As such, I've purposefully included the modern silhouette for each of these BattleMechs. Additionally, I would strongly recommend that any military man study ComStar's Technical Readout: Project Phoenix so they will be well versed in what they might encounter on the modern battlefield.

—Anastasius Focht



"In the 3060s the spindle-legged *Locust* was refitted into a more menacing profile, as shown on page 14 of *Technical Readout: Project Phoenix*."

Mass: 20 tons

Chassis: Bergan VII

Power Plant: LTV 160

Cruising Speed: 86 kph

Maximum Speed: 129 kph

Jump Jets: None

Jump Capacity: None

Armor: StarSlab/1

Armament:

1 Medium Martell Laser

2 SperryBrowning Machine Guns

Manufacturer: Bergan Industries, Alliance Defenders Limited, Majesty Metals and Manufacturing

Primary Factory: Ares (Bergan), Alpheratz (ADL), Canopus IV (Majesty)

Communications System: Garrett T10-B

Targeting and Tracking System: O/P 911

Overview

First created in 2499, the *Locust* is still one of the most common BattleMechs in operation five centuries later. While several more advanced light 'Mechs have been created over the years, few can match the *Locust's* combination of speed, endurance, and, perhaps most of all, very low cost.

Capabilities

With exceptional speed at the time of its design, the *Locust* makes for an outstanding scout, eclipsed only by scout designs equipped with jump jets. Its armor is near the maximum possible for its weight class, and its SperryBrowning machine guns make it an excellent anti-infantry 'Mech. Against other BattleMechs or against armored vehicles, it

only has a single medium laser at its disposal. It is further hampered by its lack of hands, a distinct disadvantage in physical combat.

As speed is one of its major assets, the LCT-1V is often placed where the front is fluid, as it is quick enough to respond to possible enemy breakthroughs. More often, however, the *Locust* must fight a holding action until larger, better equipped 'Mechs can arrive. It is usually deployed in groups that have the ability to encircle opposing 'Mechs.

Deployment

Present in significant numbers in every BattleMech-equipped military force known to man, *Locusts* are produced by nearly a dozen factories. They are particularly prominent in the armies of the larger Periphery states, where the LCT is a significant fraction of their limited BattleMech production capabilities. Popular among mercenary units for their relatively low cost and wide availability of parts, the *Locust* is also a prominent component of corporate defensive forces and militias.

Variants

A large number of *Locust* variants exist. House Steiner's LCT-1S replaces the machine guns with two SRM-2 launchers and drops a ton of armor. The 1M variant, popular in Davion space, further reduces the *Locust's* armor in order to mount two LRM-5 launchers. The LCT-1E replaces the machine guns to allow it to mount a medium laser and a small laser in each arm. Following the Fourth Succession War, House Liao modified *Locusts* at the Bergan Industries factory on Ares with triple-strength myomer in an effort to discover a compound that is not vulnerable to the combustion-inducing catalyst. Numerous other variants exist in smaller numbers.

Notable MechWarriors

MechWarrior Michael Ferman: Considered an exemplary light 'Mech pilot, Ferman is credited with several feats thought impossible with an LCT, including the destruction of a *Crusader*. As a member of the First Amphigean Light Assault Group's Second Battalion, Ferman has been in the thick of combat during the Galtor campaign and, during the Fourth Succession War, on Galtor III and New Aberdeen.

One of the survivors of the First from the Galtor Campaign, Ferman's knowledge of the planet's terrain allowed the regiment to quickly outmaneuver the planet's defenders at the Wuhan Pass and on the Wagnall Plains. His scouting efforts were also instrumental during the capture of New Derry. On New Aberdeen, the First further benefited from Ferman's efforts when he led his lance to the militia's field headquarters.

Type: **Locust**

Technology Base: Inner Sphere

Tonnage: 20

Battle Value: 432

Equipment

		Mass
Internal Structure:		2
Engine:	160	6
Walking MP:	8	
Running MP:	12	
Jumping MP:	0	
Heat Sinks:	10	0
Gyro:		2
Cockpit:		3
Armor Factor:	64	4
	<i>Internal Structure</i>	<i>Armor Value</i>
Head	3	8
Center Torso	6	10
Center Torso (rear)		2
R/L Torso	5	8
R/L Torso (rear)		2
R/L Arm	3	4
R/L Leg	4	8

Weapons

Weapons and Ammo	Location	Critical	Tonnage
Medium Laser	CT	1	1
Machine Gun	RA	1	.5
Machine Gun	LA	1	.5
Ammo (MG) 200	CT	1	1

STG-3R STINGER



"The 3060s saw the introduction of a full-head-assembly ejection system, providing *Stinger* pilots a better chance of surviving the destruction of their 'Mech."

Mass: 20 tons

Chassis: Earthwerks STG

Power Plant: GM 120

Cruising Speed: 64 kph

Maximum Speed: 97 kph

Jump Jets: Chilton 360

Jump Capacity: 180 meters

Armor: Riese 100

Armament:

1 Omnicron 3000 Medium Laser

2 LFN Linblad Machine Guns

Manufacturer: Earthwerks Incorporated, Coventry Metal Works

Primary Factory: Calloway VI, Grand Base, Keystone (Earthwerks), Coventry (CMW)

Communications System: Datacom 26

Targeting and Tracking System: Dynatec 990

Overview

The second mass-produced light BattleMech design, Earthwerks began distributing the *Stinger* as an alternative scout machine for the Terran Hegemony in 2479, meeting the dire need for scout 'Mechs. Over two hundred thousand were produced from over half a dozen systems. It is a testimony to the destructiveness of the Succession Wars that only five thousand *Stingers* remained by the outbreak of the Fourth Succession War. The 'Mech is still being produced inside and outside the Inner Sphere.

Capabilities

The *Stinger* is a lightly armed and armored scout that has been enormously successful in that role for nearly six centuries. Armed with a medium laser and a pair of machine guns, the *Stinger* cannot hope to match most other BattleMechs in combat. Against unarmored targets, such as infantry, the *Stinger* was the quintessential nightmare for an infantryman until the *Firestarter* appeared decades later.

With capabilities and appearances similar to the *Wasp*, many often mistake the two 'Mechs for one and the same. However, the head looks distinctly different, and MechWarriors prefer the *Wasp* as the *Stinger's* cockpit proved extremely cramped for anyone average size or greater.

Deployment

The *Stinger* created quite the stir when it was unveiled. With an appearance and movement profile very similar to the *Wasp*, GM accused Earthwerks of illegally copying their design, right down to the same fusion engine, while Earthwerks argued it was a case of convergent evolution. Lawsuits were filed back and forth for twenty years, none of which prevented the *Stinger* from rolling off the assembly line. Eventually, GM gave up pursuing the matter, with the legal fees becoming too expensive to continue the conflict.

Many *Stingers* have been pressed into training roles in the Succession Wars, replacing disappearing specialty training designs like the *Chameleon*. The iron sights of the machine guns mounted on the arms force pilots to manually maneuver their appendages to properly aim. Many MechWarriors benefited from this training, often finding that it carried over to other uses, such as becoming quite adept at operating their hand actuators and arms for handling objects, especially during objective raids or personnel extractions.

Variants

Unlike the *Wasp*, the *Stinger* does not have many variants on its chassis. The only one to gain any popularity is the STG-3G, which replaces the two machine guns and ammo with a second medium laser and extra armor. This variant is preferred by units expecting to go up against other BattleMechs, though it has problems with overheating.

Notable MechWarriors

Tai-i Marge Sippers: A young sixteen-year old *Stinger* MechWarrior serving under Captain Mercer Ravannion, then-MechWarrior Marge Sippers was a true believer in Ravannion's "Horde" tactics (many attributed this to a rumored schoolgirl crush). Despite her linkage to a disgraced officer, she nonetheless proved highly skilled in both piloting and tactics. After his death, she rose up to become *Tai-i* and led a series of surprising victories using her mentor's tactics. Sippers was, however, wise enough to trade out several of her unit's *Wasps* and *Stingers* with heavier *Jenners*.

Type: **Stinger**

Technology Base: Inner Sphere

Tonnage: 20

Battle Value: 359

Equipment

		Mass
Internal Structure:		2
Engine:	120	4
Walking MP:	6	
Running MP:	9	
Jumping MP:	6	
Heat Sinks:	10	0
Gyro:		2
Cockpit:		3
Armor Factor:	48	3
	<i>Internal Structure</i>	<i>Armor Value</i>
Head	3	4
Center Torso	6	6
Center Torso (rear)		4
R/L Torso	5	6
R/L Torso (rear)		2
R/L Arm	3	4
R/L Leg	4	5

Weapons and Ammo

	Location	Critical	Tonnage
Medium Laser	RA	1	1
Machine Gun	RA	1	.5
Machine Gun	LA	1	.5
Ammo (MG) 200	CT	1	1
Jump Jets	RT	3	1.5
Jump Jets	LT	3	1.5



"Six hundred years of service could not be ignored, although the introduction of stealth armor in the 3060s radically altered the *Wasp's* profile."

Mass: 20 tons

Chassis: 1A Type 3

Power Plant: Hermes 120

Cruising Speed: 64 kph

Maximum Speed: 97 kph

Jump Jets: Rawlings 52

Jump Capacity: 180 meters

Armor: Durallex Light

Armament:

1 Diverse Optics Type 2 Laser

1 Bical SRM 2

Manufacturer: Irian BattleMechs Unlimited,

Kali-Yama Weapons Industries, Defiance Industries

Primary Factory: Shiro III (IBMU),

Kalidasa (KYWI), Furillo (Defiance)

Communications System: Duotech 65

Targeting and Tracking System: RadCom TXX

Overview

One of the most popular 'Mechs in existence, the *Wasp* is also one of the oldest. Developed to fill a recon role for the Terren Hegemony in 2471, the original lacked missiles and was slower than the current model but performed well. Its appearance on the battlefield shocked opponents when the *Wasp* leaped into the air, using the first jump jets. In six hundred years of service, the *Wasp* has shown itself to be a quality recon workhorse in all known space. Frequently paired with the similar *Stinger*, the *Wasp* takes on a more anti-vehicular role while the *Stinger* serves as an anti-personnel 'Mech.

Capabilities

The *Wasp* is often called quick rather than fast. Never one of the fastest 'Mechs, it can nonetheless keep up or ahead of most formations, and the Rawlings jump jets allow the *Wasp* to traverse broken or urban terrain with ease. Sporting a medium laser and dual SRM tubes, the *Wasp* can hold off against other recon units and work in concert with other units to bring down enemies.

Deployment

Any place you can find BattleMechs, you can find *Wasps*. Produced by at least nine factories, every major government in the Inner Sphere and Periphery manufactures the *Wasp*. More numerous than even the common *Locust* or *Stinger*, this is a testament to the increased offensive threat of the *Wasp*.

Four 'Mechs—two *Wasps* and two *Stingers*—were responsible for the destruction of a lone Liao *Goliath* during House Davion's capture of Kittery in 3005. While the assault 'Mech massed as much as the entire lance, its heavy weaponry was inaccurate at short range against the mobile recon units. Though both *Stingers* were destroyed, the *Wasps* were eventually able to breach the *Goliath's* torso armor, setting off an ammunition explosion that destroyed the 'Mech. House Davion would repeat these tactics during the Fourth Succession War, with Delta Company's decimation of Cochraine's *Goliaths* on St. Andre.

Variants

Most *Wasp* variants replace the missile launcher; House Kurita's 1K exchanges it with a machine gun and adds more armor, while the Davion 1D version has a flamer and dual small lasers. The Capellan's 1L model drops all the weapons to mount an SRM quad-rack, while Wolf's Dragoons 1W variant replaces the weaponry with six small lasers.

Notable MechWarriors

MechWarrior Ross Malone: A noted tracker, Malone is an expert at hunting down enemy 'Mechs in his *Wasp*, "Nightshroud." Once determining their capability and intentions, Simonson's Cutthroats will spring a trap on them. Ross has frequently turned down promotions, preferring to stay in the field and use his skills.

Captain Carver McCool: Rare is the officer who commands from a *Wasp*, but Captain McCool leads from the front in his recon company for House Liao's Red Lancers. While morale dropped under Romano's rule, McCool refused to give in to the pall that clouded his realm. Despite his talent, subordinates from other companies complained of physical abuse from Captain McCool, but those reports were buried.

Type: **Wasp**

Technology Base: Inner Sphere

Tonnage: 20

Battle Value: 384

Equipment

Internal Structure:

Engine: 180

Walking MP: 6

Running MP: 9

Jumping MP: 6

Heat Sinks: 10

Gyro: 2

Cockpit: 3

Armor Factor: 48

	Internal Structure	Armor Value
Head	3	4
Center Torso	6	6
Center Torso (rear)		4
R/L Torso	5	6
R/L Torso (rear)		2
R/L Arm	3	4
R/L Leg	4	5

Head: 3

Center Torso: 6

Center Torso (rear): 4

R/L Torso: 5

R/L Torso (rear): 2

R/L Arm: 3

R/L Leg: 4

Weapons and Ammo

	Location	Critical	Tonnage
Medium Laser	RA	1	1
SRM 2	LL	1	1
Ammo (SRM) 50	LT	1	1
Jump Jet	RT	1	.5
Jump Jet	RL	1	.5
Jump Jet	LT	1	.5
Jump Jet	LL	1	.5
Jump Jets	CT	2	1

VLK-QA VALKYRIE



"Changes in components resulted in changes of shape, but the *Valkyrie* that debuted in the 3060s is just as deadly to the enemies of the Federated Suns."

Mass: 30 tons

Chassis: Corean Model 1AA

Power Plant: Omni 150

Cruising Speed: 54 kph

Maximum Speed: 86 kph

Jump Jets: Norse Industries 3S

Jump Capacity: 150 meters

Armor: Reize 470

Armament:

1 Sutel IX Medium Laser

1 Devastator Series-7 LRM 10

Manufacturer: Corean Enterprises

Primary Factory: New Avalon

Communications System: Lynx-shur

Targeting and Tracking System: Sync-Tracker
(39-42071)

Overview

The *Valkyrie* is a popular light 'Mech with the Armed Forces of the Federated Suns and has been in near-constant production since the fall of the Star League. The Corean manufacturing facility on New Avalon was one of the most automated factories left after the Star League. After the recovery of the Helm Memory Core, technicians from the New Avalon Institute of Science were able to return the factory to its Star League production capabilities, making the *Valkyrie* one of the standard light 'Mechs of the Federated Commonwealth.

Capabilities

Although blessed with only average speed for a light BattleMech, the *Valkyrie's* claim to fame is the ten-tube

Devastator long-range missile battery in the 'Mech's chest. Capable of lofting one hundred and twenty missiles in two minutes, the LRM system gives the *Valkyrie* striking power unmatched by almost any other light 'Mech. An arm-mounted Sutel medium laser provides close-in defense, and a quintet of superb Norse 3S jump jets allows the *Valkyrie* to flee whenever it is outmatched.

For a 30-ton 'Mech the *Valkyrie* is well armored, and the location of the 'Mech's production facility on the Davion capital ensures an abundant supply of replacement 'Mechs and equipment. The prolific dispersion of the 'Mech means that most AFFS techs are intimately familiar with it and are able to get it repaired quickly, if not always easily.

Deployment

The *Valkyrie* appears in every Davion military unit and almost every battalion. In scout lances it provides covering fire, and in recon companies full lances of *Valkyries* cover the advance of the rest of the company. It is often detached within RCTs to support infantry formations, giving them supporting fire when needed.

A number of *Valkyries* appear in mercenary formations as well due to the AFFS's lenient procurement policies for contracted mercenaries as well as battlefield salvage. Other states operate the 'Mech in limited numbers, but for House Davion, it is a mainstay.

Variants

The rare VLK-QF *Valkyrie* has a flamer replacing the medium laser, which is often used to ignite covering fires to allow *Valkyrie* fire teams to escape pursuit.

Notable MechWarriors

Leftenant Sir Reginald Timmson: A lance commander in the elite Third Davion Guards, Leftenant Timmson leads his lance of two *Valkyries* and two *Jenners* with a flair that is common in the Davion military. Although not of noble birth, Sir Reginald was knighted for his actions in the War of 3039 on Vega, where his lance was instrumental in blunting a Kuritan advance against the Guards' regimental headquarters.

When faced with an advancing company, Leftenant Timmson ordered his *Jenners* forward to try to slow the enemy advance. Although they didn't cause any substantial damage, the 'Mechs were able to slow the Kuritans enough that the *Valkyries* were able to get into a position to rain LRM fire down upon them. Two *Valkyries* weren't enough to stop the Kuritans, but Leftenant Timmson's delaying action allowed other elements of the Third to mobilize and cut off the DCMS attack.

Type: **Valkyrie**

Technology Base: Inner Sphere

Tonnage: 30

Battle Value: 723

Equipment

		Mass
Internal Structure:		3
Engine:	150	5.5
Walking MP:	5	
Running MP:	8	
Jumping MP:	5	
Heat Sinks:	11	1
Gyro:		2
Cockpit:		3
Armor Factor:	96	6
	<i>Internal Structure</i>	<i>Armor Value</i>
Head	3	8
Center Torso	10	14
Center Torso (rear)		4
R/L Torso	7	12
R/L Torso (rear)		2
R/L Arm	5	9
R/L Leg	7	12

Weapons and Ammo

	Location	Critical	Tonnage
LRM 10	LT	2	5
Ammo (LRM) 12	RT	1	1
Medium Laser	RA	1	1



"Although sterling service has kept the *Ostscout* in constant use, upgrades in the 3060s gave the 'Mech a bit more presence on the battlefield."

Mass: 35 tons

Chassis: Kell/S

Power Plant: VOX 280

Cruising Speed: 86 kph

Maximum Speed: 129 kph

Jump Jets: Ostmann Sct-A

Jump Capacity: 240 meters

Armor: Durallex Light

Armament:

1 Tronel II Medium Laser

Manufacturer: Kong Interstellar Corporation

Primary Factory: Connaught (destroyed 2802)

Communications System: Barret 4000

Targeting and Tracking System: TRSS.2L3

Overview

Looking to capitalize on the success of their *Ostroc*, Ostmann Industries attempted to break into the market for support BattleMechs. A pure scout, the *Ostscout* (debuting in 2600), was sold to units in need of a swift reconnaissance BattleMech. However, as demand for their *Ostroc* grew, Ostman's limited production capabilities could not keep pace, and the design was licensed to be manufactured by the larger Kong Interstellar Corporation in 2700, in much the same way the *Ostsol* had been licensed seven years prior to allow the *Ostroc* an additional production line.

Carrying enhanced sensor arrays and superior electronic suites, an *Ostscout* was known for accumulating more information than it could analyze, often needing to move slowly to ensure it was not moving into an enemy trap, negating its main advantage of speed.

Capabilities

The *Ostscout*'s primary feature is pure speed. Its VOX 280 fusion engine is typically mounted on designs twice its size. Also equipped with a 240-meter jump capability, only the *Spider* can match its maneuverability, and that light 'Mech carries less than the four-and-a-half tons of armor possessed by the *Ostscout*.

Because of this, the *Ostscout*'s combat capability is severely limited. A single medium laser is all the design has, mounted after many of the test pilots aggressively protested the lack of weaponry on the original chassis.

Deployment

Being such an ineffective combat unit, few notable declassified stories of *Ostscouts* exist for public consumption. The most notable success of the design came during 3024, when a Capellan *Ostscout* was dropped to scout out landing zones for a retaliatory strike against Smithson's Chinese Bandits, who raided Sian two years prior. The scout, MechWarrior Mary Finn, was accidentally dropped behind the lines instead, and on what would be known as the "Thousand Kilometer Chase," eluded the Bandit patrols for ten hours until she could make her way to an extraction point, accumulating enough intelligence for a successful reprisal raid.

Unfortunately, many *Ostscouts* have had their precious sensor arrays heavily damaged throughout the years, and numerous units have had them replaced with less-effective, but more robust and traditional, electronics suites.

Variants

Because of *Ostscout*'s specialist nature, no known variants of the 'Mech exist.

Notable MechWarriors

Commander Mary "Hopscotch" Finn: Once attached to the Chesterton Reserves, Mary Finn would later be turned into an independent scout working for various Confederation commands. Her exploits, the most famous being the Thousand Kilometer Chase, became textbook examples of evading enemy patrols and avoiding enemy contact. Shortly after the Fourth Succession War, her tactics became the

most studied examples of conduct by the Capellan Armed Forces underneath Chancellor Romano Liao.

In addition, her ability as a competent technician allowed her to keep her advanced (and now rare) sensors array operationally, which was invaluable in the R&D of the *Raven* project. Now a test pilot for Hellestont, she had made her displeasure known at the lack of speed and maneuverability her new *Raven* has compared to her old *Ostscout*.

Type: **Ostscout**

Technology Base: Inner Sphere

Tonnage: 35

Battle Value: 596

Equipment

Internal Structure:

Engine: 280

Walking MP: 8

Running MP: 12

Jumping MP: 8

Heat Sinks: 10

Gyro: 3

Cockpit: 3

Armor Factor: 72

	Internal Structure	Armor Value
Head	3	6
Center Torso	11	12
Center Torso (rear)		4
R/L Torso	8	9
R/L Torso (rear)		2
R/L Arm	6	6
R/L Leg	8	8

Weapons and Ammo

Weapons and Ammo	Location	Critical	Tonnage
Medium Laser	CT	1	1
Jump Jets	RT	4	2
Jump Jets	LT	4	2

PXH-1 PHOENIX HAWK

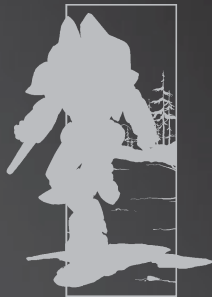

"Page 24 of *Technical Readout: Project Phoenix* reveals this legend's frightening new facelift, the result of years of testing and refinement of the *Phoenix Hawk*."

Mass: 45 tons
Chassis: Earthwerks PXH
Power Plant: GM 270
Cruising Speed: 64 kph
Maximum Speed: 97 kph
Jump Jets: Rawlings 45
Jump Capacity: 180 meters
Armor: Durallex Light
Armament:
 1 Harmon Large Laser
 2 Harmon Medium Lasers
 2 M100 Machine Guns
Manufacturer: Earthwerks Incorporated,
 Coventry Metal Works, Achernar BattleMechs,
 Gorton, Kingsley, and Thorpe Enterprises
Primary Factory: Keystone (Earthwerks),
 Coventry (CMW), New Avalon (Achernar),
 New Oslo (GKT)
Communications System: Neil 6000
Targeting and Tracking System: Octagon Tartrac
 System C

Overview

The *Phoenix Hawk* is a relic of the Star League era, produced during that time in great numbers. A staple of recon lances almost since its prototype, the basic PXH model has been in standard service of every House military since the fall of the Star League and is still produced (or being reintroduced) in almost every Successor State. It is almost considered the meterstick by which other BattleMechs are rated, and in reconnaissance circles, it is the meterstick.

Capabilities

Built around a strengthened *Wasp* chassis, the *Phoenix Hawk* is designed to operate in concert with its lighter cousins like the *Wasp* and *Stinger*. It follows the same basic design philosophy, with similar weaponry and movement profiles, and armor more suited to short actions than brawls. The Harmon large laser gives it the firepower to threaten other 'Mechs, supported by pairs of lighter lasers and machine guns. Massive Rawlings jump jets mounted behind the PXH's shoulders give it an impressive 180-meter jump radius, almost unprecedented for a 'Mech of its mass.

If the *Phoenix Hawk* has weaknesses, they are faults common to nearly all 'Mechs: not enough armor and heat sinks. Many PXHs have been lost by green MechWarriors who are too trusting in their armor or who allow their heat burden to climb too high. An experienced pilot who knows the 'Mech, however, is often deadly.

Deployment

The *Phoenix Hawk*, in one incarnation or another, appears in almost every 'Mech unit in the Inner Sphere, although it is most common in the regiments of the Free Worlds League. It is no stranger, however, to the militaries of the Periphery or even pirate bands, a legacy of its long service life and longevity in battle.

Variants

With so many chasses in existence, variants are found everywhere, but several main configurations appear in the various Successor State militaries. House Davion's PXH-1D removes the machine guns and their ammunition for another pair of heat sinks; House Kurita's PXH-1K removes the jump jets to add armor and heat sinks, and replaces the machine guns with a small laser.

Notable MechWarriors

Tai-i David Kellam: Commander of a strike company in House Kurita's Night Stalkers, Kellam (with his *Phoenix Hawk* "*The Knife*") is a man strangely suited to command. He earned his position on his merits alone by being the MechWarrior in the Night Stalkers with the most kills. After the heavy fighting of the War of 3039 he was placed in charge of a company due to a lack of qualified officers.

The *Tai-i* does not socialize with his men and barely speaks to them outside of combat. Rumors of his lethality have been confirmed; during the lull between the Fourth War and the *Ronin* War of 3034, Kellam killed three other officers in duels after being snubbed in the required social convocations of the DCMS. His tenacity in battle, however, soon excused his surly behavior.

Type: Phoenix Hawk

Technology Base: Inner Sphere
 Tonnage: 45
 Battle Value: 1,041

Equipment

		Mass
Internal Structure:		4.5
Engine:	270	14.5
Walking MP:	6	
Running MP:	9	
Jumping MP:	6	
Heat Sinks:	10	0
Gyro:		3
Cockpit:		3
Armor Factor:	128	8
	<i>Internal Structure</i>	<i>Armor Value</i>
Head	3	6
Center Torso	14	23
Center Torso (rear)		5
R/L Torso	11	18
R/L Torso (rear)		4
R/L Arm	7	10
R/L Leg	11	15

Weapons

and Ammo	Location	Critical	Tonnage
Large Laser	RA	2	5
Medium Laser	RA	1	1
Machine Gun	RA	1	.5
Medium Laser	LA	1	1
Machine Gun	LA	1	.5
Ammo (MG) 200	CT	1	1
Jump Jets	RT	3	1.5
Jump Jets	LT	3	1.5

GRF-1N GRIFFIN



"Although the upgrades gave the *Griffin* more powerful weaponry and better armor, the 'Mech's silhouette is only slightly changed with the addition of more bulk."

Mass: 55 tons

Chassis: Earthwerks GRF

Power Plant: CoreTek 275

Cruising Speed: 54 kph

Maximum Speed: 86 kph

Jump Jets: Rawlings 55

Jump Capacity: 150 meters

Armor: Starshield A

Armament:

1 Fusigon Particle Projectile Cannon

1 Delta Dart Long Range Missile Ten-Rack

Manufacturer: Earthwerks Incorporated, Defiance Industries, Kallon Industries

Primary Factory: Keystone (Earthwerks), Hesperus II (Defiance), Talon (Kallon)

Communications System: Neil 6000

Targeting and Tracking System: Octagon Tartrac, System C

Overview

One of the first designs to fill the void between the massive *Mackie* and the smaller recon 'Mechs, the *Griffin* was considered an advanced design for the time. With the mobility of a recon unit and the firepower and armor of a heavy 'Mech, Earthwerks' creation reigned supreme on the battlefield for a brief period. Then everything else caught up, leaving the *Griffin* filling the role of a mobile fire-support unit.

Capabilities

Fast and equipped with substantial long-range striking power, the *Griffin* is a favorite of pilots and command-

ers. With two tons of ammo for the missile launcher and almost ten tons of armor, the *Griffin* has staying power as long as the pilot watches heat levels. The only notable weaknesses the 'Mech possesses are the lack of short-ranged weapons and the concentration of weaponry on the right side.

A Lyran *Griffin* and *Black Knight* battled a Davion *Grasshopper* and *Trebuchet* on New Earth in the Second Succession War over a cache of *Stingrays*. With the *Griffin* providing fire support, the *Knight* closed but collapsed after inflicting massive damage. When a well-placed PPC shot detonated the *Trebuchet's* ammunition, the combat became a duel between two abused 'Mechs. Damage to the 'Mechs' legs limited their mobility, and both kept collapsing. The *Griffin* finally backed off and used its PPC to finish the crippled *Grasshopper*. After the battle, the exhausted MechWarriors found their efforts were moot—a treaty hammered out by diplomats gave the fighters back to the Free Worlds League.

Deployment

Any major military will have *Griffins* on their roster. The Capellan Confederation is the only great House not manufacturing the design, but they are able to purchase a limited number from the Taurian Concordat.

Variants

The only production variant is made on Hesperus II by Defiance Industries. The GRN-1S downgrades the PPC to a large laser and the LRM-10 rack to a five-tube rack but adds a pair of medium lasers and four additional heat sinks. This has turned the *Griffin* from a long-range support 'Mech into a medium-range brawler.

Notable MechWarriors

MechWarrior "Dropkick" Darwin Webster: A member of Winfield's Brigade, "Dropkick" is well known for using his *Griffin*, "Hopalong" to get in close against opponents. Shocked by his presence, they aren't ready for his version of death from above, the jump-kick. Though this has left Hopalong battered, his opponents take the brunt of the damage.

MechWarrior Elle Bennett: A new recruit from Sanglamore, Elle performed admirably as the Fifth Donegal Guards drove into the Draconis Combine during the War of 3039. On Alrakis, Combine forces weren't ready for "*Sparky*," her *Griffin* modified to replace the launcher with five medium lasers, armor, and another heat sink. On Alrakis, Elle would trade fire with *Shadow Hawks* and *Dragons* before closing on them. At short range, they found themselves outmatched by Elle and Sparky but unable to escape. Elle racked up eight kills this way, leaving a laser-cut "E" in each victim's fallen 'Mech.

Type: **Griffin**

Technology Base: Inner Sphere

Tonnage: 55

Battle Value: 1,272

Equipment

Equipment		Mass
Internal Structure:		5.5
Engine:	275	15.5
Walking MP:	5	
Running MP:	8	
Jumping MP:	5	
Heat Sinks:	12	2
Gyro:		3
Cockpit:		3
Armor Factor:	152	9.5
	<i>Internal Structure</i>	<i>Armor Value</i>
Head	3	9
Center Torso	18	20
Center Torso (rear)		7
R/L Torso	13	20
R/L Torso (rear)		6
R/L Arm	9	14
R/L Leg	13	18

Weapons and Ammo

Weapons and Ammo	Location	Critical	Tonnage
PPC	RA	3	7
LRM 10	RT	2	5
Ammo (LRM) 24	RT	2	2
Jump Jets	RT	2	1
Jump Jets	LT	2	1
Jump Jet	CT	1	.5

SCP-1N SCORPION



"Long considered the lemon of BattleMechs, the 3060s *Scorpion* with more weapons and armor changed the way MechWarriors viewed the much-maligned brawler."

Mass: 55 tons

Chassis: Brigadier 800F

Power Plant: VOX 330

Cruising Speed: 64 kph

Maximum Speed: 97 kph

Jump Jets: None

Jump Capacity: None

Armor: StarSlab/4

Armament:

1 Anderson Armaments Particle Cannon PPC 12

1 Marvel Six-Load Short-Range Missile Rack

Manufacturer: Brigadier Corporation

Primary Factory: Oliver (destroyed 2837)

Communications System: Garret 500A

Targeting and Tracking System: Garret GRNDTRK 9

Overview

Brigadier started out as a contract manufacturer for the Terran Hegemony but had never developed a design of their own, the place where real profits are made. Their board finally made a decision to boldly move ahead, and they extracted Dr. David Harrison from Hollis Incorporated, where he was embroiled in the *Xanthos* debacle. Freed from the bureaucratic constraints of Hollis and the Confederation and armed with the lessons learned from the failures of the *Xanthos*, he worked with Brigadier's designers to bring his dream of a four-legged 'Mech to fruition in 2570. Dr. Harrison predicted that the *Scorpion* would change 'Mech combat forever, but it was received with little praise outside the company. Despite this setback, Brigadier was able to eke out enough sales to fund Dr. Harrison's continued work.

Capabilities

While Dr. Harrison's theories argued that four-legged 'Mechs would be a more stable firing platform than two-legged 'Mechs, any *Scorpion* pilot would disagree. This configuration gives the design more mobility, but the ride is far from smooth. Luckily the *Scorpion* is fast for its size and can take advantage of this mobility. The armament is decent, with a PPC able to punch holes in the enemy at distance while a six-tube SRM launcher can be used to exploit those holes when closing. The huge mass of the reactor left little room for armor, forcing *Scorpion* pilots to act like their 'Mech's namesake and find smaller prey. Another complaint is that, due to the minimal armor, the ammunition bin is very exposed on the left side, leading many pilots to fire their missiles even when they have a poor firing solution or to dump their ammo entirely after suffering moderate armor damage.

Deployment

The few remaining *Scorpions* are scattered throughout the Inner Sphere. The Federated Commonwealth possesses the lowest numbers of the design. The Lyrans cannibalized their *Scorpions* for parts in the mid 3020s, a process which their Davion counterparts have begun in the wake of the War of 3039.

Variants

Other than MechWarriors jury-rigging armor plating in different locations, there are no common variants of the *Scorpion*.

Notable MechWarriors

MechWarrior Wednall Puritian II: A member of Smithson's Chinese Bandits, Puritian left the Lyran Commonwealth when he learned his family 'Mech was going to be destroyed. He has struggled with its upkeep after the Fourth Succession War and was unable to procure a replacement for his damaged PPC and has been forced to use a large laser instead. Though he misses the bite of the PPC, he enjoys using the additional tonnage for more armor.

MechWarrior Klaus Schenker: Schenker inherited his *Scorpion*, "Unbreakable," when its previous pilot, Regent Ryal, was killed. He named his 'Mech after being told that it would not get any more replacement limbs, and he has made it live up to its name ever since. Klaus racked up fifteen kills between 3029 and 3039, more than the rest of his lance combined. He is itching to get back into combat and prove his detractors in procurement wrong.

Type: **Scorpion**

Technology Base: Inner Sphere

Tonnage: 55

Battle Value: 1,019

Equipment

		Mass
Internal Structure:		5.5
Engine:	330	24.5
Walking MP:	6	
Running MP:	9	
Jumping MP:	0	
Heat Sinks:	10	0
Gyro:		4
Cockpit:		3
Armor Factor:	112	7
	<i>Internal Structure</i>	<i>Armor Value</i>
Head	3	8
Center Torso	18	24
Center Torso (rear)		8
R/L Torso	13	11
R/L Torso (rear)		5
R/L F Leg	13	10
R/L R Leg	13	10

Weapons

Weapons and Ammo	Location	Critical	Tonnage
PPC	RT	3	7
SRM 6	RT	2	3
Ammo (SRM) 15	LT	1	1

SHD-2H SHADOW HAWK



"Centuries have proven the *Shadow Hawk* a competent 'Mech, but newer versions make it even more powerful, with better weapons and thicker, more menacing armor."

Mass: 55 tons

Chassis: Earthwerks SHD

Power Plant: CoreTek 275

Cruising Speed: 54 kph

Maximum Speed: 86 kph

Jump Jets: Pitban LFT-50

Jump Capacity: 90 meters

Armor: Maximillian 43

Armament:

- 1 Armstrong J11 Autocannon
- 1 Holly Long Range Missile 5 Rack
- 1 Holly Short Range Missile 2 Pack
- 1 Martel Model 5 Medium Laser

Manufacturer: Earthwerks Incorporated,

Majesty Metals and Manufacturing

Primary Factory: Calloway VI (Earthwerks),
Dunianshire (Majesty)

Communications System: O/P 300 COMSET

Targeting and Tracking System: O/P 2000A

Overview

Though debuting years earlier, the *Shadow Hawk* was forced into a recall when it was discovered that the armor plating could sever key myomer bundles during combat. The overhaul went smoothly and production restarted in 2550, which many historians deemed as the true debut of the multi-role design.

Capabilities

The Star League wanted a medium BattleMech that could function in a variety of roles, and that is what the *Shadow Hawk* delivered. For long- and medium-range exchanges, the Armstrong Autocannon and Holly LRM rack

do the job adequately, backed by an SRM launcher and medium laser at short range.

Its pilots however, value the advanced life-support system the most. The Sparrow 300J is known for keeping MechWarriors comfortable almost a third longer than most other systems, allowing for a sharper and more relaxed pilot during long missions.

Deployment

In widespread use throughout the Inner Sphere and Periphery, the *Shadow Hawk* has always been considered one of the most versatile designs in its weight class, and it boasts an impressive battle record. With its jump capacity and dexterous hand actuators, *Shadow Hawks* have been used for reconnaissance, fire support, raiding, and a wide variety of other operations, both large and small.

The Second Proserpina Hussars used several lances of their 2K variants to great effect while raiding Hean in 2920. Attacking supply bases, both sides took heavy losses, but the Hussars were able to capture several hundred tons of supplies and destroyed thousands more. The logistical problems caused by these raids would frustrate the Davion troops in future campaigns against both the Combine and the Confederation.

Variants

Houses Kurita and Davion have modified their *Shadow Hawks* in great numbers.

The Federated Suns 2D model removes much of its armor for a second medium laser and SRM pack, and an additional two heat sinks. While impressive in firepower, its four-and-a-half tons of armor is completely inadequate, and units with these *Shadow Hawks* deploy them in ambushes, hoping to get a deadly opening salvo before falling to counter fire.

House Kurita on the other hand, has a much different variant in the form of the 2K. All the weapons save the LRM system are replaced by heat sinks and a PPC. Highly esteemed by those that pilot it, many Lyran soldiers derided the variant as a "*Griffin* knockoff" despite its contribution to victories on Alexandria and Baxter.

Notable MechWarriors

Sergeant Celeste Rio: With her bionic arm and a personality perceived as even more mechanical, MechWarrior Rio gained infamy among the Houses and many mercenary units when Hansen's Roughriders raided the system of

Shiloh for the Lyran Commonwealth. Marik Fighters heavily contested the combat drop, but Rio was credited with scattering the defenders by shooting down a pair of aerospace fighters during her atmospheric descent, which resulted in a crash landing and the loss of her arm. Though several generous offers for her to transfer to other units followed, she instead settled into semi-retirement, training new recruits for her unit.

Type: **Shadow Hawk**

Technology Base: Inner Sphere

Tonnage: 55

Battle Value: 1,064

Equipment

Internal Structure:

Engine:	275	15.5
Walking MP:	5	
Running MP:	8	
Jumping MP:	3	
Heat Sinks:	12	2
Gyro:		3
Cockpit:		3
Armor Factor:	152	9.5

	<i>Internal Structure</i>	<i>Armor Value</i>
--	-------------------------------	------------------------

Head	3	9
Center Torso	18	23
Center Torso (rear)		8
R/L Torso	13	18
R/L Torso (rear)		6
R/L Arm	9	16
R/L Leg	13	16

Weapons

and Ammo

	Location	Critical	Tonnage
AC/5	LT	4	8
Ammo (AC) 20	LT	1	1
LRM 5	RT	1	2
Ammo (LRM) 24	RT	1	1
SRM 2	H	1	1
Ammo (SRM) 50	CT	1	1
Medium Laser	RA	1	1
Jump Jet	RT	1	.5
Jump Jet	CT	1	.5
Jump Jet	LT	1	.5

WVR-6R WOLVERINE



"The 3060s saw the resurrection of a number of chasses, and the *Wolverine's* was one that benefited more than most from the new methods of design and manufacture."

Mass: 55 tons

Chassis: Crucis-A

Power Plant: CoreTek 275

Cruising Speed: 54 kph

Maximum Speed: 86 kph

Jump Jets: Northrup 12000

Jump Capacity: 150 meters

Armor: Maximillian 60

Armament:

1 Whirlwind Autocannon 5

1 Harpoon-6 SRM Launcher

1 Magna Mk II Medium Laser

Manufacturer: Kallon Industries, Victory Industries, Free Worlds Defense Industries

Primary Factory: Nanking, Thermopolis (Kallon), Marduk (Victory), Gibson (FWDI)

Communications System: Garret T11-b

Targeting and Tracking System: Sync Tracker (39-42071)

Overview

Conceived as a heavy scout capable of undertaking assignments too hazardous for lighter recon 'Mechs, Kallon Industries' *Wolverine* has been produced in prodigious numbers. The design was introduced in 2575 as the newly created Star League Defense Force prepared for the now-inevitable conflict with the Periphery realms. The *Wolverine* went on to serve with distinction and was later made available to the League Member States, in whose ranks it remains in service to this day.

Capabilities

Well armored and relatively fast, the *Wolverine's* mobility is enhanced by its Northrup 12000 jump jets. Unfortunately the Northrups are slightly underpowered for this role and must be run at close to maximum thrust. Consequently, thermal and mechanical failures are common.

As a scout, the *Wolverine* is not as heavily armed as many other BattleMechs in its weight class. Rather, the design emphasizes endurance and survivability. Even with engine damage, twelve heat sinks can cope easily with the heat generated when moving and fighting. Despite the limited scope of its intended role, the *Wolverine* is able to hold its own as a mainline BattleMech.

Deployment

A common sight on the battlefields of the Succession Wars, the majority of *Wolverines* reside within the FWLM, followed by the armies of the Federated Commonwealth. The Federated Suns' capture of the Capellan's Nanking *Wolverine* line during the Fourth Succession War was offset by the loss of their own *Wolverine* line on Marduk to the Draconis Combine. Nanking's larger production facilities left the Capellans as the only loser.

Variants

Following the Reunification War, House Kurita did away with the troublesome Northrup 12000 jump jets on many of their *Wolverines*. Replacing the Whirlwind autocannon with one large, one medium, and one small laser, the WVR-6K carries two additional heat sinks and two tons of extra armor.

The WVR-6M became the mainstay of House Marik's medium BattleMech forces during the Succession Wars. By replacing the Whirlwind autocannon with a large and medium laser, Marik engineers were able to add two heat sinks and an additional ton of armor.

Notable MechWarriors

Hauptmann Lisa Morgan: Serving with House Steiner's Eleventh Lyran Guards, Morgan commanded a recon company during the bitter fighting on Kimball II. By 2932 the world had already changed hands several times, and Morgan's company was pushed to the limit executing raids and commando missions in addition to normal scouting.

Dispatched on a hazardous night mission, the Guards' scouts were ambushed by a battalion of Kurita's Tenth Rasalhague Regulars. Rallying her troops, Morgan tried to

punch through the tightening cordon of Combine BattleMechs. Hopelessly outgunned, her *Wolverine* was crippled by enemy fire and fell. As the Combine commander's *BattleMaster* closed in to administer the *coup de grace*, Morgan fired her missiles in one last act of defiance. The salvo struck the Combine 'Mech's head and shoulders, instantly killing the MechWarrior and sending the Rasalhague Regulars falling back in disarray.

Taking advantage of the confusion, Morgan and her troops gathered up the fallen assault 'Mech, which was later awarded to Morgan, and made good their escape.

Type: **Wolverine**

Technology Base: Inner Sphere

Tonnage: 55

Battle Value: 1,101

Equipment

		Mass
Internal Structure:		5.5
Engine:	275	15.5
Walking MP:	5	
Running MP:	8	
Jumping MP:	5	
Heat Sinks:	12	2
Gyro:		3
Cockpit:		3
Armor Factor:	152	9.5

	Internal Structure	Armor Value
Head	3	8
Center Torso	18	20
Center Torso (rear)		8
R/L Torso	13	20
R/L Torso (rear)		6
R/L Arm	9	16
R/L Leg	13	16

Weapons and Ammo

	Location	Critical	Tonnage
AC/5	RA	4	8
Ammo (AC) 20	RA	1	1
SRM 6	LT	2	3
Ammo (SRM) 15	LT	1	1
Medium Laser	H	1	1
Jump Jets	RL	2	1
Jump Jet	CT	1	.5
Jump Jets	LL	2	1



"The upgrades to the formerly-delicate *Ostroc* made it a much more effective heavy 'Mech, as can be seen on page 34 of *Technical Readout: Project Phoenix*."

Mass: 60 tons

Chassis: Ost-II

Power Plant: Vlar 300

Cruising Speed: 54 kph

Maximum Speed: 86 kph

Jump Jets: None

Jump Capacity: None

Armor: Riese 475

Armament:

1 Totschlagen SRM Quad Launcher

2 Fuersturm-c Large Lasers

2 Fuersturm-b Medium Lasers

Manufacturer: Ostmann Industries

Primary Factory: Terra (destroyed 2777)

Communications System: Ostmann-L

Targeting and Tracking System: Ferdinand-a

Overview

Created in 2511 by Ostmann Industries, the *Ostroc* was designed for combat in an urban environment. With its reduced profile and powerful array of weaponry, the OSR-2C was a popular addition to the garrisons of the Terran Hegemony. Ostmann's limited production facilities on Terra kept the number of operational Ost-based 'Mechs initially low. Ostmann licensed out their subsequent designs to Kong Interstellar so they could concentrate on producing the *Ostroc*, which would become a large component of the Star League Defense Force, especially in garrison units. The number of operational Ost 'Mechs has dwindled since the destruction of the production facilities during the Amaris Civil War and the First Succession War.

Capabilities

Intended primarily for urban defense, the *Ostroc* heralded the familiar walker/pod profile later seen in the heavier *Stalker* and *Marauder* 'Mechs, while the low silhouette makes it a difficult target, especially when obscured by buildings or trees.

The *Ostroc* has a powerful array of weaponry at medium and short range, including the well-designed Fuersturm lasers and the excellent Totschlagen SRM launcher. Swift for its size and equipped with fifteen heat sinks, the *Ostroc* is a capable BattleMech even outside an urban landscape. Its weak arm protection often costs it one or both arms in battle, a liability in close-quarters combat.

Deployment

Although primarily deployed among the garrisons of the Terran Hegemony, the *Ostroc* saw action in every major conflict of the Star League. It also featured prominently in the seizure of Terra by ComStar, where the *Ostroc* was found on both sides of the conflict. A persistent legend holds that Jerome Blake was also a MechWarrior and places him in an *Ostroc* during this campaign. A company of *Ostrocs* is credited with disrupting the invasion of Bolan, and *Ostrocs* enabled the conquest of Solaris VII.

Variants

A number of *Ostroc* variants exist, but none are particularly numerous. The 2L replaces the SRM with an LRM launcher, while the 3C adds a third large laser at the expense of the other weaponry. Kong Interstellar produced the experimental 2M version with jump jets for the Free Worlds League after the annexation of Connaught, but it was only manufactured in small numbers prior to the factory's destruction.

Notable MechWarriors

MechWarrior David Levine: A gifted technician, Levine upgraded his *Ostroc* to improve its detection and communications abilities. These enhancements allowed Levine and the Twenty-second Avalon Hussars to stage several successful raids against Draconis Combine border garrisons. This attracted the attention of Hanse Davion, who wanted to replicate Levine's work on other Davion *Ostrocs*.

Before this effort could begin, Combine bounty hunters attempted to capture Levine—accidentally killing him and destroying his 'Mech in the process.

Lieutenant James LeMonds: Commanding an urban assault lance among the Twenty-first Centauri Lancers, LeMonds has made a name for himself as a capable commander. Piloting an OSR-3C, LeMonds has mastered the considerable heat-load of its brace of large lasers, ripple-firing his weaponry and ducking for cover to shed excess heat.

Type: **Ostroc**

Technology Base: Inner Sphere

Tonnage: 60

Battle Value: 1,228

Equipment

		Mass
Internal Structure:		6
Engine:	300	19
Walking MP:	5	
Running MP:	8	
Jumping MP:	0	
Heat Sinks:	15	5
Gyro:		3
Cockpit:		3
Armor Factor:	144	9
	<i>Internal Structure</i>	<i>Armor Value</i>
Head	3	8
Center Torso	20	22
Center Torso (rear)		6
R/L Torso	14	22
R/L Torso (rear)		4
R/L Arm	10	8
R/L Leg	14	20

Weapons

Weapons and Ammo	Location	Critical	Tonnage
Large Laser	RT	2	5
Medium Laser	RT	1	1
SRM 4	RT	1	2
Ammo (SRM) 25	CT	1	1
Large Laser	LT	2	5
Medium Laser	LT	1	1

OTL-4D OSTSOL



“Long admired as a cavalry ‘Mech—and despised in almost every other role—the *Ostsol* was brought back to life and widespread use with the upgrades of the 3060s.”

Mass: 60 tons

Chassis: Kell/H

Power Plant: 300 Vlar

Cruising Speed: 54 kph

Maximum Speed: 86 kph

Jump Jets: None

Jump Capacity: None

Armor: Valiant Lamellor

Armament:

2 Tronel III Heavy Lasers

4 Tronel II Medium Lasers

Manufacturer: Kong Interstellar Corporation

Primary Factory: Connaught (destroyed 2802)

Communications System: Barret 509p

Targeting and Tracking System: TRSS.2L3

Overview

Ostmann Industries followed up their success with the *Ostroc* in 2693 by making a pitch for a contract to produce a heavy ‘Mech capable of independent operations. However, strong demand for their previous design had their manufacturing plants running at maximum capacity. Seeking a partner, Ostmann settled on the Kong Interstellar Corporation, a manufacturer enjoying few successes after the introduction of their own *Black Knight*. Within a year Kong-manufactured *Ostsois* were entering service with SLDF Dragoon and Hussar regiments. More were sold to the League Member States after 2752, after an amendment to Edict 2650 which allowed the House Lords to double the size of their armies.

Damage to Kong’s manufacturing plants on Connaught halted production of new *Ostsois* during the Succession Wars, but with so many already in the field, the ‘Mech remains a common sight.

Capabilities

The chassis and many components owe much to Ostmann Industries’ previous “Walker-Pod” design, the *Ostroc*. The design criteria set down in the contract for which Ostmann Industries created the *Ostsol* called for a heavy BattleMech with a maximum speed of at least 80 kph, medium armor, and energy-based weapons. With no need to resupply, the ‘Mech’s endurance is limited only by that of its MechWarrior, making it ideal for operating behind enemy lines. The highly sensitive TRSS.2L3 sensors allow the *Ostsol* to detect enemy units at extended ranges even in difficult terrain. Consequently, *Ostsois* can be found operating as the command vehicle in recon or lightning lances, or providing support to heavier ‘Mechs. It is often difficult to accurately judge the *Ostsol*’s contribution to the battle, as its role is often much less conspicuous than that played by heavier ‘Mechs.

In 2826 two companies of Davion’s First Crucis Lancers were deployed in the polar region of Talon for training exercises. When the pair of *Ostsois* in one lance detected a group of unidentified ‘Mechs, they assumed it was part of the exercise and closed to attack, only to find it was in fact a Fire Lance from the Twelfth Star Guards. Between contracts and down on their luck, the mercenaries were scavenging for equipment and attacked at once. Finding themselves under real fire, the Lancers were too close to retreat in good order. Things went badly until the Lancer’s lead *Ostsol* closed with an *Archer* and unleashed a furious assault with lasers, fists, and feet that smashed the heavy ‘Mech and sent the mercenaries into retreat.

Variants

As a stopgap measure to replace heavier BattleMechs during the Succession Wars, House Davion created the OTL-4F *Ostsol* by replacing all the lasers with two Dominion-V PPCs. Unfortunately, the heat generated quickly overloads the sixteen heat sinks, and this variant remains uncommon.

Notable MechWarriors

Gunsho Lynn Woo: A samurai serving with the prestigious Seventh Sword of Light, Woo takes great pride in her reputation as a sharpshooter. Decorated for her pivotal role in several battles, Woo has demonstrated repeatedly the effectiveness of the humble *Ostsol*.

Type: **Ostsol**

Technology Base: Inner Sphere

Tonnage: 60

Battle Value: 1,245

Equipment

		Mass
Internal Structure:		6
Engine:	300	19
Walking MP:	5	
Running MP:	8	
Jumping MP:	0	
Heat Sinks:	16	6
Gyro:		3
Cockpit:		3
Armor Factor:	144	9
	<i>Internal Structure</i>	<i>Armor Value</i>
Head	3	8
Center Torso	20	22
Center Torso (rear)		6
R/L Torso	14	22
R/L Torso (rear)		4
R/L Arm	10	8
R/L Leg	14	20

Weapons and Ammo

	Location	Critical	Tonnage
Large Laser	RT	2	5
Medium Laser	RT	1	1
2 Medium Lasers	CT (R)	2	2
Large Laser	LT	2	5
Medium Laser	LT	1	1

RFL-3N RIFLEMAN



"Perhaps the most distinctive 'Mech of the Succession Wars, the *Rifleman* received one of the most radical changes, giving the 'Mech a much bulkier profile."

Mass: 60 tons

Chassis: Kallon Type IV

Power Plant: Pitban 240

Cruising Speed: 43 kph

Maximum Speed: 64 kph

Jump Jets: None

Jump Capacity: None

Armor: Kallon Royalstar

Armament:

2 Magna Mk. III Large Lasers

2 Magna Mk. II Medium Lasers

2 Imperator-A Autocannon

Manufacturer: Kallon Industries, Trelshire Heavy Industries, Red Devil Industries

Primary Factory: Talon, Thermopolis, Nanking (Kallon), Twycross (Trelshire), Pandora (Red Devil)

Communications System: Garret T11-A

Targeting and Tracking System: Garret D2j

Overview

Conceived of as a medium fire-support platform, chronic overheating problems plagued the RFL-1N *Rifleman* following its debut in 2505. The RFL-2N corrected some of the issues, but the engineers at Kallon Industries thought they could do better. In 2770 Kallon unveiled the heavier RFL-3N *Rifleman*. Exchanging lasers for an autocannon, this version was manufactured for the Star League in quantity.

Combat losses and an increasing inability to replace the 'Mech forced the Successor States to deploy the *Rifleman* as a frontline combat machine. Even today the RFL-3N

is regularly found serving with backwater militia, mercenary commands, and even House Regulars at the bottom of the supply totem-pole.

Capabilities

In its intended role as a fire-support vehicle, the *Rifleman* excels. The Garret D2j targeting system and Imperator autocannon are a deadly accurate combination, especially against airborne targets. The *Rifleman* frequently acts as an anti-aircraft platform to provide air defense. In other roles, the *Rifleman* fares less well. Its limited supply of ammunition renders it ill suited to participate in prolonged engagements. Light armor and a lack of hand and lower-arm actuators leaves it vulnerable in close combat with other 'Mechs. Like the D2j, the Garret T11-A communications system is an exceptional piece of electronics, but its distinctive wing-shaped antenna tends to draw enemy fire, which disrupts communications in *Rifleman* units.

House Davion possesses the largest concentration of *Riflemen*, and the machines have seen action all across Davion territory. Colonel Hezekiah Walden's tactics on New Rhodes III during the First Succession War remain a classic example of how to use the *Rifleman*. With House Kurita's offensive driving on New Avalon, New Rhodes III became the site of some of the fiercest fighting of the campaign. With the vital spaceport of Polis under threat, Colonel Walden deployed his 'Mechs on the heights overlooking a strategic pass. Advancing Kurita BattleMechs came under accurate and sustained fire from Walden's *Riflemen*. Faced with mounting losses, the Combine spearhead was forced to fall back. The successful defense of Polis marked the turning point of the entire campaign.

During the Third Battle of Harrow's Sun in 3020, the *Rifleman* was employed in its anti-aircraft role—keeping Kurita fighters at a respectful distance while the Davion siege of the city of Mura progressed.

Variants

House Davion has attempted several modifications to its *Riflemen*. The RFL-4D replaces the autocannon with PPCs, but despite the addition of three heat sinks, this variant suffers from severe overheating problems. A second variant, the RFL-3C, replaces both the autocannon and large lasers with heavier Class-10 weapons and adds a ton of much-needed armor.

Notable MechWarriors

Gray Noton: One of the greatest MechWarriors to fight in the Solaris VII arenas, Noton held the top spot for an unprecedented seven years before retiring. His reign as Champion was all the more remarkable because his *Rifleman*, "Legend-Killer", was completely outclassed by the assault 'Mechs he regularly defeated. Suggestions that Noton recovered an advanced Star League prototype remain unconfirmed following his unsolved murder in 3027.

Type: **Rifleman**

Technology Base: Inner Sphere

Tonnage: 60

Battle Value: 1,039

Equipment

Internal Structure:

Engine: 240

Walking MP: 4

Running MP: 6

Jumping MP: 0

Heat Sinks: 10

Gyro: 3

Cockpit: 3

Armor Factor: 120

	Internal Structure	Armor Value
Head	3	6
Center Torso	20	22
Center Torso (rear)		4
R/L Torso	14	15
R/L Torso (rear)		2
R/L Arm	10	15
R/L Leg	14	12

Weapons and Ammo

	Location	Critical	Tonnage
Large Laser	RA	2	5
AC/5	RA	4	8
Medium Laser	RT	1	1
Ammo (AC) 20	CT	1	1
Medium Laser	LT	1	1
Large Laser	LA	2	5
AC/5	LA	4	8

CRD-3R CRUSADER



"Never a slender BattleMech, the new-production *Crusaders* are some of the most thickset machines on the field, giving the impression of twenty more tons of mass."

Mass: 65 tons

Chassis: Crucis-b

Power Plant: Magna 260

Cruising Speed: 43 kph

Maximum Speed: 64 kph

Jump Jets: None

Jump Capacity: None

Armor: Riese 500

Armament:

2 Magna Longbow-15 LRM Launchers

2 Harpoon-6 SRM Launchers

2 Intek Medium Lasers

2 M100 Heavy Machine Guns

Manufacturer: TharHes Industries, Brigadier Corporation, Kallon Industries

Primary Factory: Tharkad (TharHes), Oliver (Brigadier), Asuncion, Bernardo (Kallon)

Communications System: Garret T11-b

Targeting and Tracking System: Garret A6

Overview

Introduced in the late twenty-sixth century, the CRD-3R *Crusader* became the workhorse of the SLDF's line regiments as they battled Periphery troops during the Reunification War. With manufacturing plants across the Inner Sphere, Kallon Industries manufactured the Mech in vast numbers during the two centuries of the First Star League. Even after the League collapsed, other manufacturers continued to churn out *Crusaders*, making it one of the most common heavy BattleMechs in existence. Many of these have fallen during the Succession Wars, but a surprising number of the surviving veterans remain in frontline service, and the availability of inexpensive and easy-to-install upgrade kits will ensure that they stay there.

Capabilities

Earning a reputation as a reliable and versatile design, the *Crusader* has been adapted to fill a wide variety of roles, from main BattleMech to fire support, anti-aircraft platform, and even reconnaissance.

The first battles of the Reunification War revealed a problem with the arm-mounted Longbow missile launchers. During prolonged combat the combined heat from the missile exhaust and the Intek medium lasers caused excessive stress on the arm actuators and internal structure. Kallon's engineers devised special collars to deflect the hot gasses away from the arms, and by the end of the Reunification War all of the League's *Crusaders* had been retrofitted. The placement of the Harpoon launchers in the hips is somewhat unusual. Although the arc of fire is constrained, it offers a very stable firing platform and ensures that salvos of long- and short-range missiles are less prone to interfere with each other.

The *Crusader's* staying power has been demonstrated time and again. In 3015 a single battalion of House Davion's Thirty-fourth Avalon Hussars, composed primarily of *Crusaders*, held at bay a Kurita force twice their size on Bergman's Planet. Using their DropShips as mobile supply depots, the *Crusaders* alternated combat and resupply in staggered shifts, returning to the battle with full loads of missiles to hurl at the enemy.

Variants

Variants of the *Crusader* frequently focus on the Mech's inadequate cooling system. House Davion's CRD-3D *Crusader* removes the machine guns and downgrades the Harpoon launchers to quad-racks. Four additional heat sinks greatly improve combat endurance.

Kurita's CRD-3K *Crusader* retains its short-range firepower but drops the machine guns and downgrades the long-range missile launchers to Longbow-10 racks to mount six additional heat sinks.

The CRD-3L *Crusader* is based on a Star League variant used for raiding and reconnaissance. Both the short- and long-range missile launchers are downgraded to allow the CRD-3L to mount GM Jetstar jump jets and two extra heat sinks.

Notable MechWarriors

MechWarrior Charles Bear: A third-generation MechWarrior descended from Native American ancestors, Bear has

served with such renowned mercenary commands as the Ceti Rangers, Twenty-first Centauri Lancers, and the Gray Death Legion.

A quiet, somewhat secretive man, Bear does not mix with his fellow MechWarriors. Despite his less-than-friendly manner, he is well respected for his battlefield prowess and loyalty to his comrades. Younger MechWarriors regard this towering mysterious man with awe and not a little fear.

Type: **Crusader**

Technology Base: Inner Sphere

Tonnage: 65

Battle Value: 1,317

Equipment

Internal Structure:

Engine: 260 Mass 6.5

Walking MP: 4 13.5

Running MP: 6

Jumping MP: 0

Heat Sinks: 10 0

Gyro: 3

Cockpit: 3

Armor Factor: 192 12

	Internal Structure	Armor Value
Head	3	9
Center Torso	21	33
Center Torso (rear)		8
R/L Torso	15	24
R/L Torso (rear)		6
R/L Arm	10	20
R/L Leg	15	21

Weapons and Ammo

	Location	Critical	Tonnage
LRM 15	RA	3	7
Ammo (LRM) 8	RT	1	1
LRM 15	LA	3	7
Ammo (LRM) 8	LT	1	1
Medium Laser	RA	1	1
Machine Gun	RA	1	.5
Medium Laser	LA	1	1
Machine Gun	LA	1	.5
Ammo (MG) 200	CT	1	1
SRM 6	RL	2	3
SRM 6	LL	2	3
Ammo (SRM) 15	CT	1	1

TDR-5S THUNDERBOLT

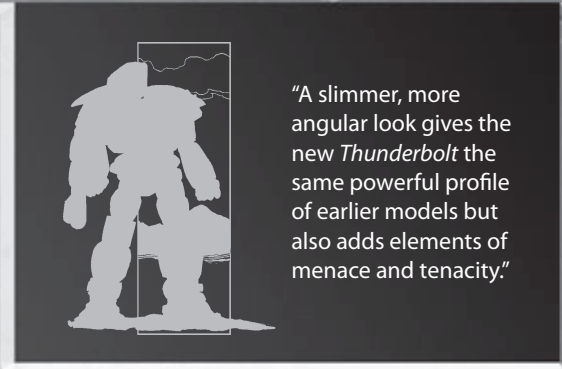

"A slimmer, more angular look gives the new *Thunderbolt* the same powerful profile of earlier models but also adds elements of menace and tenacity."

Mass: 65 tons

Chassis: Earthwerks TDR

Power Plant: Magna 260

Cruising Speed: 43 kph

Maximum Speed: 64 kph

Jump Jets: None

Jump Capacity: None

Armor: Ryerson 150

Armament:

- 1 Sunglow Type 2 Large Laser
- 1 Delta Dart Long Range Missile 15 Rack
- 3 Diverse Optics Type 18 Medium Lasers
- 1 Bical Short Range Missile Twin-Rack
- 2 Voelkers 200 Machine Guns

Manufacturer: Earthwerks Incorporated

Primary Factory: Keystone

Communications System: Neil 8000

Targeting and Tracking System: RCA Instatrac Mark X

Overview

First produced in 2491, the TDR-5S *Thunderbolt*—or *T-Bolt* as it is affectionately known—is a familiar sight throughout the Successor States. One of the first 'Mechs designed for planetary assaults, it is renowned for its heavy firepower. Though later superseded by larger and more advanced designs, the *Thunderbolt's* excellent design and fearsome reputation has kept it in production.

Capabilities

One of the best-armed 'Mechs in existence, the *Thunderbolt's* long-range punch come from a Sunglow Type 2

large laser and a drum-mounted Delta Dart LRM 15 launcher, while three Diverse Optics Type 18 medium lasers provide a formidable broadside at closer ranges. A Bical SRM twin-rack and a pair of anti-infantry Voelkers 200 machine guns round out the weaponry.

The *Thunderbolt's* thirteen tons of Ryerson 150 armor is another impressive feature, often outclassing 'Mechs nearly twenty-five tons heavier.

The 'Mech's heavy weaponry is also its Achilles heel, as MechWarriors must ride the heat curve carefully or else risk shutdown and ammunition explosions. Many commanders order their *Thunderbolts* into bodies of water on the battlefield, allowing them to better utilize their armaments.

Deployment

Used extensively by every military across the Inner Sphere and Periphery, *Thunderbolts* appear in heavy lances and even light assault forces. Houses Steiner and Marik are the 'Mechs primary users, though these mercantile nations have sold production runs to other states. House Liao used to field significant numbers of the 'Mech, though the destruction of the Fourth Succession War and Andurien War severely curtailed this number. In the Periphery, the Taurian Concordat—with two *Thunderbolt* factories—uses the 'Mech as the backbone of its military.

Variants

Surprisingly for such an ancient design, only two major variants of the *Thunderbolt* exist. The Steiner TDR-5SS replaces the Sunglow large laser with a Kreuss PPC, substitutes the LRM rack for an SRM-6, and exchanges the Bical SRM pack for two Zippo flamers. The Eridani Light Horse mercenaries have adapted their *Thunderbolts* to act as raiding and reconnaissance units. The TDR-5SE adds Chilton 420 jump jets and an LRM-10 rack at the expense of the LRM-15, the SRM twin-rack, and machine guns.

Notable MechWarriors

Captain "Dashing John" MacAllister: Commander of Eridani Light Horse's Forty-first Support Company, the Ass Extractors, "Dashing John" models himself after the cavalry officers of ancient Terran history. During the War of 3039, the Seventy-first Light Horse was abandoned on Fellanin II due to a bureaucratic mistake. With the White Horse regiment pinned down in Fort Jinjiro by the Second Arkab Legion

and the remnants of the Fourth Proserpina Hussars, Colonel Alfieri ordered his battered unit to retreat off-world. Harried all the way back to their LZ, MacAllister fought a desperate rearguard action, setting up numerous ambushes and luring the Kuritans into his artillery's kill zones. The Ass Extractors accounted for over two companies of Kuritan 'Mechs, allowing the majority of the Eighty-second Cavalry Battalion to safely reach the DropShips. Though blown out of his *Thunderbolt*, the "*Toujours L'Audace*," MacAllister was later repatriated in early 3040.

Type: **Thunderbolt**

Technology Base: Inner Sphere

Tonnage: 65

Battle Value: 1,335

Equipment

Equipment	Mass
Internal Structure:	6.5
Engine:	13.5
Walking MP:	4
Running MP:	6
Jumping MP:	0
Heat Sinks:	5
Gyro:	3
Cockpit:	3
Armor Factor:	13

	Internal Structure	Armor Value
Head	3	9
Center Torso	21	30
Center Torso (rear)		11
R/L Torso	15	24
R/L Torso (rear)		6
R/L Arm	10	20
R/L Leg	15	29

Weapons and Ammo

	Location	Critical	Tonnage
Large Laser	RA	2	5
LRM 15	RT	3	7
Ammo (LRM) 16	CT	2	2
3 Medium Lasers	LT	3	3
SRM 2	RT	1	1
Ammo (SRM) 50	RT	1	1
2 Machine Guns	LA	2	1
Ammo (MG) 200	LA	1	1

ARC-2R ARCHER



“Traditional *Archers* often gave the impression of relaxed watchfulness. The new *Archers* of the 3060s change that, with a more forward-leaning, aggressive structure.”

Mass: 70 tons

Chassis: Earthwerks Archer

Power Plant: VOX 280

Cruising Speed: 43 kph

Maximum Speed: 64 kph

Jump Jets: None

Jump Capacity: None

Armor: Maximillian 100

Armament:

4 Diverse Optics Type 18 Medium Lasers

2 Doombud Long Range Missile 20 Racks

Manufacturer: Earthwerks Incorporated, Vandenberg Mechanized Industries, Gorton, Kingsley & Thorpe Enterprises (GKT)

Primary Factory: Calloway VI (Earthwerks), New Vandenberg (VMI), Satalice (GKT)

Communications System: Neil 9000

Targeting and Tracking System: RCA Instatrac Mark XII

Overview

The *Archer*, with its low-slung torso, massive fists, and missile-bay coverings, has one of the most recognizable BattleMech profiles. Designed for heavy-hitting, long-range brawling, and fire-support, production commenced in 2474, and despite the carnage of the Succession Wars the *Archer* continues to be produced to this day.

Capabilities

The core of the *Archer's* firepower is a pair of massive Doombud LRM-20 launchers supplied with four tons of ammunition. Though powerful, the missiles' inaccuracy at short range necessitated the addition of four medium lasers, two rear facing and one mounted in each arm.

Enlarged hand actuators not only allow the design to perform devastating physical attacks but also to carry captured supplies away during raids.

The *Archer* is one of the few BattleMechs whose cockpit is located beneath the central torso, giving the pilot a battlefield perspective quite different from most normal cockpit positions. The armor protection is excellent, and with the torso armor belt is located above the cockpit area, it further protects the gyro and engine. When first produced, many pilots entered battle with their missile bays closed to conceal the 'Mech's true capabilities, leading some to believe it was a specialized close-combat design. Over time this pretense became pointless, as the *Archer* became so well-known. The *Archer* is so old and well known that there are few new tricks developed by *Archer* pilots, but this has not dulled the 'Mech's reputation in the least.

Deployment

Six factories continue to produce the *Archer*, with a number of these also building house specific variations. Over a hundred thousand of the 2R models were built prior to the Succession Wars, as were tens of thousands of variants over the centuries. Though many were destroyed, large numbers have survived to spread across the Inner Sphere and Periphery.

Variants

Numerous variants of the *Archer* exist. The Steiner 2S variant downgrades the LRM racks to mount a pair of SRM 4 packs. Wolf's Dragoons use a similar variant dubbed the 2W, which reduces the armor by three tons and drops the rear-mounted lasers.

In widespread use with the DCMS and the Royal Kung-sArmé, the 2K variant is more radical. It sacrifices two tons of armor, the medium lasers, and replaces the Doombud launchers with FarFire 15 racks in exchange for a pair of arm-mounted large lasers and two additional heat sinks.

Notable MechWarriors

Colonel Morgan Kell: With a life like the plot of a holo vid, Morgan Kell's life has seen events even less believable than the Immortal Warrior series. Eldest son of the Duke of Arc-Royal, Morgan and his brother Patrick used their family fortunes, and monies inherited from their cousin Duke Arthur Luvon, to form the Kell Hounds mercenary unit in 3010.

Their exploits would become legendary. After defeating Yorinaga Kurita's Second Sword of Light on Mallory's World in 3016 (the same campaign that saw the death of First Prince Ian Davion), Kell discovered a talent within himself so devastating that withdrew into exile at the St. Marinus monastery on Zaniah. After Patrick's death, at the hands of Yorinaga Kurita during the rescue of Melissa Steiner, Morgan returned to command the Kell Hounds. In a virtual replay of their battle on Mallory's World thirteen years earlier, Morgan avenged his brother's death by defeating Yorinaga Kurita for a second time.

Type: Archer

Technology Base: Inner Sphere

Tonnage: 70

Battle Value: 1,464

Equipment

		Mass
Internal Structure:		7
Engine:	280	16
Walking MP:	4	
Running MP:	6	
Jumping MP:	0	
Heat Sinks:	10	0
Gyro:		3
Cockpit:		3
Armor Factor:	208	13
	<i>Internal Structure</i>	<i>Armor Value</i>
Head	3	9
Center Torso	22	33
Center Torso (rear)		10
R/L Torso	15	24
R/L Torso (rear)		6
R/L Arm	11	22
R/L Leg	15	26

Weapons

Weapons and Ammo	Location	Critical	Tonnage
LRM 20	RT	5	10
Ammo (LRM) 12	RT	2	2
LRM 20	LT	5	10
Ammo (LRM) 12	LT	2	2
Medium Laser	RA	1	1
Medium Laser	LA	1	1
2 Medium Lasers	CT (R)	2	2

WHM-6R WARHAMMER



"Many of the great MechWarriors of history drove *Warhammers*, and with its distinctive new body style, many of the great MechWarriors to come will as well."

Mass: 70 tons

Chassis: StarCorps 100

Power Plant: VOX 280

Cruising Speed: 43 kph

Maximum Speed: 64 kph

Jump Jets: None

Jump Capacity: None

Armor: Leviathon Plus

Armament:

2 Donal PPCs

2 Martell Medium Lasers

2 Magna Small Lasers

1 Holly Short Range Missile 6 Pack

2 SperryBrowning Machine Guns

Manufacturer: StarCorps Industries, Olivetti

Weaponry, Vandenberg Mechanized Industries,

Taurus Territorial Industries

Primary Factory: Emris IV (StarCorps),

Sudeten (Olivetti), Pinard (VMI), Taurus (TTI)

Communications System: O/P 3000 COMSET

Targeting and Tracking System: O/P 1500 ARB

Overview

When requesting its design, the procurement officer asked for "a mobile 'Mech with enough firepower to destroy or severely damage any 'Mech of the same weight class or lower." StarCorps Industries responded with the aptly named *Warhammer*, and the 'Mech has been smashing its opponents for more than five hundred years. The 'Mech served ably in the Star League, forming the backbone of several heavy and battle regiments, and was a popular 'Mech with the Star League Gunslingers.

Capabilities

The *Warhammer* almost defines the heavy weight class of BattleMechs. Respectable armor protects a framework supporting a pair of deadly Donal particle projection cannons, allowing the *Warhammer* to threaten even the heaviest armor. A six-tube Holly short-range missile system supports these cannons and is itself backed by pairs of medium and small lasers and SperryBrowning machine guns.

With a top speed of 64 kph the *Warhammer* can keep pace with almost any battle, and eighteen heat sinks allow it the freedom to move and fire without undue concern over heat buildup. Dated but still competitive electronics make the *Warhammer* a simple but effective machine, equally capable of serving in the line of combat or in a command slot.

Deployment

First deployed in 2515, the *Warhammer* has served admirably in every major action in the Inner Sphere and beyond, from the liberation of Terra from Stefan Amaris to the bloody fields of Marduk in 3039. Every Successor State military makes use of the design, and it is held in high regard by mercenaries and Periphery nations.

The *Warhammer* is produced in several factories, most notably in the Free Worlds League and Lyran Commonwealth. Surprisingly, two small facilities exist in the Taurian Concordat, slowly bringing new 'Mechs to that faraway Periphery nation. No manufacturer has ever scaled back production of this 'Mech, as demand has always increased with each new battle report.

Variants

With its long history and varied service, variants of the *Warhammer* abound. The WHM-6D favored in Davion space removes the Holly launcher and the Magna lasers in favor of heat sinks and armor, while the WHM-6K version (Kurita) retains the missiles. House Liao's WHM-6L adds flamers to its so-called "Hot Hammers" in place of the machine guns. The only certainty when facing a *Warhammer* is that, whatever the configuration, the 'Mech will deal out punishment.

Notable MechWarriors

Colonel Natasha Kerensky: Commander of the Black Widow Battalion of Wolf's Dragoons, the so-called "First Lady of Death" is regarded as one of the deadliest MechWarriors in history. She first came to prominence leading an inde-

pendent company of the Dragoons in 3014, when her unit was instrumental in the fall of Anton Marik after his betrayal of the Dragoons during the Marik Civil War—some say that she personally killed Duke Anton. Since then she only added to that reputation, and her black *Warhammer* was the most recognized BattleMech since her namesake Aleksandr Kerensky's *Orion*.

Type: **Warhammer**

Technology Base: Inner Sphere

Tonnage: 70

Battle Value: 1,299

Equipment

Internal Structure:

Engine:

Walking MP:

Running MP:

Jumping MP:

Heat Sinks:

Gyro:

Cockpit:

Armor Factor:

Mass

7

16

4

6

0

8

3

3

10

*Internal
Structure*

*Armor
Value*

Head

3

9

Center Torso

22

22

Center Torso (rear)

9

9

R/L Torso

15

17

R/L Torso (rear)

8

8

R/L Arm

11

20

R/L Leg

15

15

Weapons and Ammo

	Location	Critical	Tonnage
PPC	RA	3	7
PPC	LA	3	7
SRM 6	RT	2	3
Ammo (SRM) 15	RT	1	1
Medium Laser	RT	1	1
Small Laser	RT	1	.5
Machine Gun	RT	1	.5
Medium Laser	LT	1	1
Small Laser	LT	1	.5
Machine Gun	LT	1	.5
Ammo (MG) 200	CT	1	1

MAD-3R MARAUDER



"Since the first Star League, the *Marauder* has been one of the most feared 'Mechs on the field, and in the 3060s this beast got a monster-scale facelift."

Mass: 75 tons

Chassis: GM Marauder

Power Plant: Vlar 300

Cruising Speed: 43 kph

Maximum Speed: 64 kph

Jump Jets: None

Jump Capacity: None

Armor: Valiant Lamellor

Armament:

2 Magna Hellstar PPCs

2 Magna Mk II Medium Laser

1 GM Whirlwind AC/5

Manufacturer: General Motors, Independence Weaponry

Primary Factory: Kathil (GM), Quentin (Independence)

Communications System: Dalban Micronics

Targeting and Tracking System: Dalban Hi-Rez

Overview

When it was unveiled, the *Marauder* was hailed as one of the pinnacles of BattleMech design, one of the first 'Mechs to step away from the purely humanoid body type and embrace a more menacing appearance. The 'Mech quickly became popular as a command vehicle, and throughout the Succession Wars many battalion and regimental commanders made their *Marauders* their second homes on the battlefield. During the years of the Star League the *Marauder* was a favorite of both the SLDF Gun-slingers and the Kuritan *ronin* they faced.

Capabilities

Designed as a frontal assault 'Mech, the *Marauder* is built to charge forward into enemy defenses and shatter them. A matched gauntlet on each arm contains a Magna Hellstar PPC and a medium laser, while a powerful torso-mounted Whirlwind cannon allows the *Marauder* to lay down a covering barrage as it advances. Sixteen heat sinks allow a competent MechWarrior to keep their heat burden under control. The *Marauder's* heavy armor allows it to close with its opponents, though the unusual profile leaves the autocannon and torso rotator rings vulnerable to enemy fire.

Deployment

Although produced prodigiously across the Inner Sphere and Periphery, the *Marauder* has always remained rare due to its prominence on the battlefield. Being able to claim a kill against a *Marauder* has always been a source of respect among MechWarriors. It is often found in attack lances or command lances, and is most often the personal 'Mech of senior commanders or their bodyguards.

Over the centuries several deployment schemes have been tried. *Marauders* have been matched with other 'Mechs in attempts to build more balanced units, but the most successful cases have always been massed numbers of MADs in units like Miller's Marauders or, for a short time, a regiment of McCarron's Armored Cavalry.

Variants

Although rare, there are several variants of the basic *Marauder* in existence. House Marik's MAD-3M is armed with large lasers in place of the PPCs, while House Davion's MAD-3D replaces the Whirlwind. The MAD-3L *Marauders* of the Capellan Confederation seem unable to decide, replacing only one PPC with a large laser. In recent years another version, the larger *Marauder II*, has appeared in the ranks of Wolf's Dragoons and select other units.

Notable MechWarriors

Colonel Grayson Death Carlyle: Founder and commander of the elite Gray Death Legion, Grayson Carlyle has made a career out of scrounging the best from a bad situation. Although his mercenary command has rightly claimed the reputation of one of the best mercenary regiments

currently operating in the Inner Sphere, that reputation has not come without great cost. The Legion is most famous for its recovery of an intact Star League Memory Core on Helm during the lull between the Third and Fourth Succession Wars, a fact made even more famous by the taint of the Tiantan Massacre on Sirius V—an atrocity blamed on the Legion. Colonel Carlyle captured his *Marauder* in combat against the Combine on Verthandi and pilots it into battle regularly at the head of his Legion.

Type: **Marauder**

Technology Base: Inner Sphere

Tonnage: 75

Battle Value: 1,363

Equipment

		Mass
Internal Structure:		7.5
Engine:	300	19
Walking MP:	4	
Running MP:	6	
Jumping MP:	0	
Heat Sinks:	16	6
Gyro:		3
Cockpit:		3
Armor Factor:	184	11.5

	Internal Structure	Armor Value
Head	3	9
Center Torso	23	35
Center Torso (rear)		10
R/L Torso	16	17
R/L Torso (rear)		8
R/L Arm	12	22
R/L Leg	16	18

Weapons and Ammo

	Location	Critical	Tonnage
PPC	RA	3	7
PPC	LA	3	7
Medium Laser	RA	1	1
Medium Laser	LA	1	1
AC/5	RT	4	8
Ammo (AC) 20	LT	1	1



"As seen on page 50 of *Technical Readout: Project Phoenix*, the new *Goliath* replaces the slender awkwardness of previous models with a predatory philosophy."

Mass: 80 tons

Chassis: Corean VIII

Power Plant: Hermes 320

Cruising Speed: 43 kph

Maximum Speed: 64 kph

Jump Jets: None

Jump Capacity: None

Armor: StarSlab/3

Armament:

1 Rand PPC

2 Holly Long Range Missile 10 Racks

2 Voelkers 200 Machine Guns

Manufacturer: Brigadier Corporation, Corean Enterprises

Primary Factory: Oliver (Brigadier, destroyed 2837), Stewart (Corean)

Communications System: Corean TransBand-J9

Targeting and Tracking System: Corean B-Tech

Overview

After the limited success of the *Scorpion*, Dr. Harrison and Brigadier went on to produce a larger version. While the *Scorpion* was not a good design, it also had to overcome the issues with a four-legged chassis. By learning from their failures with the *Scorpion* and the *Xanthos*, they were not only able to overcome many of the problems that the *Scorpion* suffered from but also to make a quality design. Sadly, the questionable nature of the *Scorpion* made the *Goliath* a hard sell, and the Star League passed on the design. After over a century of good but limited service in the Periphery and House armies, the League inquired about purchasing some *Goliaths*, but the deal

fell through as the Amaris Coup and the dissolution of the Star League occurred.

Capabilities

The *Goliath* is a steady fire-support unit, with a PPC and dual LRM racks providing good ranged firepower. At 64 kph, it can keep up with heavy units and some lighter 'Mechs, while almost fifteen tons of armor let it take quite a beating. One of the strongest points of the *Goliath* is the number of heat sinks that allows it to keep up almost a constant rate of fire. Up close, the *Goliath* suffers. Dual machine guns might be good at fending off infantry, but against armored units they are almost useless, while the long-ranged weaponry is inaccurate.

Deployment

Very few *Goliaths* remain, and most of those are split between Lyran units and the Free Worlds League. The Lyran Commonwealth put a priority on maintaining their *Goliaths* while Corean manufactures a few new *Goliaths* each year. Defiance Industries makes spare parts for the *Goliath* and has discussed manufacturing it, but they held out for an upgraded design before beginning production.

Despite the rarity of the 'Mech (there has been only one recorded instance of a *Goliath vs. Goliath* fight), it has been involved in many important battles. In a 2901 battle for Sirius, a Marik *Goliath* was the centerpiece in their attack on Liao position. Moving through a hole in the line, the *Goliath* was able to reach the rear guard protecting the Capellan's headquarters unit. The *Goliath* disabled a *Battle-Master* and a pair of *Shadow Hawks*, allowing the rest of the lance to wipe out the headquarters staff and push the Capellan line back forty kilometers.

Variants

With so few *Goliaths* in service, no variants are known to exist.

Notable MechWarriors

MechWarrior Warren Hestrus: A member of the Twenty-sixth Lyran Guard and the current owner of the victor of

the much discussed *Goliath vs. Goliath* battle, Warren is trying to turn the focus from his 'Mech to him. On Engadin during the Fourth Succession War, a Kuritan *Panther* decided to be the "David" in a David vs. Goliath fight. Unlike the biblical legend, David was defeated handily. Warren tallied up another half-dozen kills between then and the War of 3039, where the Twenty-sixth fought on Alnasi.

Type: **Goliath**

Technology Base: Inner Sphere

Tonnage: 80

Battle Value: 1,449

Equipment

Internal Structure:

Engine: 320

Walking MP: 4

Running MP: 6

Jumping MP: 0

Heat Sinks: 17

Gyro: 4

Cockpit: 3

Armor Factor: 232

	Internal Structure	Armor Value
Head	3	9
Center Torso	25	30
Center Torso (rear)		19
R/L Torso	17	20
R/L Torso (rear)		13
R/L Front Leg	17	24
R/L Rear Leg	17	30

Weapons

and Ammo

	Location	Critical	Tonnage
PPC	RT	3	7
LRM 10	RT	2	5
LRM 10	LT	2	5
Ammo (LRM) 24	CT	2	2
Machine Gun	RT	1	.5
Machine Gun	LT	1	.5
Ammo (MG) 200	LT	1	1

BLR-1G BATTLEMASTER



"Additional streamlined armor along with serrated shoulder baffles help shield the classic cockpit assembly from damage, improving the old *BattleMaster's* pilot protection."

Mass: 85 tons

Chassis: Hollis Mark X

Power Plant: VOX 340

Cruising Speed: 43 kph

Maximum Speed: 64 kph

Jump Jets: None

Jump Capacity: None

Armor: StarGuard IV

Armament:

1 Donal PPC

6 Martell Medium Lasers

2 SperryBrowning Machine Guns

1 Holly Short Range Missile 6 Pack

Manufacturer: Earthwerks Incorporated,

Red Devil Industries

Primary Factory: Keystone (Earthwerks),

Pandora (Red Devil)

Communications System: HarfordCo COM 4000

Targeting and Tracking System: HarfordCo XKZ 1

Overview

Debuting in 2633 for the Star League, the *BattleMaster* is one of the most iconic chassis of its time. Many stories of the *BattleMaster's* superior abilities have circulated, from it holding off entire lances single-handedly to a single *BattleMaster* taking out the defenders of important outposts during an invasion. Though Hollis' main factories on Corey were destroyed during the First Succession War, production has continued. However, the special needs of such a massive chassis have limited the number produced to only a handful per year.

Capabilities

The *BattleMaster's* armament is quite formidable, with a forward-firing Donal PPC and four Martell medium lasers. A pair of SperryBrowning machine guns and a Holly SRM 6 pack give it impressive capabilities against conventional forces, while a pair of rear-mounted medium lasers combined with fourteen-and-a-half tons of armor only enhance the *BattleMaster's* aura of invulnerability.

Deployment

Either as a command 'Mech or as an anchor in an assault lance, the *BattleMaster* is favored among those who have the privilege of having one. Its heavy armor and fire-power make the *BattleMaster* highly valued, though this unfortunately marks the design as a high-profile target to be destroyed early during a fight.

Only produced in moderate numbers, the 'Mech is a relatively common sight across the Inner Sphere as techs will go to great lengths to patch a damaged *BattleMaster* back together. The armies of Houses Steiner and Marik contain the most *BattleMasters* due to their possession of functional production lines. Prior to the Fourth Succession War, the Capellan Confederation also possessed a large number of *BattleMasters* within its ranks, though quite a number of these have since fallen to the military juggernaut of the Federated Suns.

Variants

Red Devil Industries produces a missile-support version of the *BattleMaster* for Lyran units. Stripping out everything except the forward-firing lasers, the BLR-1S mounts an array of both short- and long-range missiles and adds two more heat sinks.

Lacking any production capabilities for the design, House Davion instead created the 1D variant. By stripping out the missiles and rear lasers for an extra ton of armor and six additional heat sinks, Davion increased the survivability of their remaining *BattleMasters* in high-intensity conflicts.

Notable MechWarriors

First Prince Hanse Davion: Depending on the person's loyalties, Hanse Davion is either a messiah or the devil incarnate. Taking the mantle from his brother Ian following his death on Mallory's World in 3013, he would go on to

not only found NAIS, but also bind the militarily powerful Federated Suns and the economic juggernaut of the Lyran Commonwealth into one entity. Not one to shy away from combat, he was responsible for holding off an attack by Li-ao's elite Death Commandos with only his *BattleMaster*, defending the fledgling NAIS until the remnants of Team Banzai slowly arrived and relieved him just before he sustained critical damage. [EDITOR'S NOTE: The attack would later be revealed as a covert strike by ComStar attempting to destroy the NAIS and its copy of the Helm Memory Core.]

Type: **BattleMaster**

Technology Base: Inner Sphere

Tonnage: 85

Battle Value: 1,494

Equipment

Internal Structure:

Engine: 340

Walking MP: 4

Running MP: 6

Jumping MP: 0

Heat Sinks: 18

Gyro: 4

Cockpit: 3

Armor Factor: 232

Internal Structure

Head 3

Center Torso 27

Center Torso (rear) 11

R/L Torso 18

R/L Torso (rear) 8

R/L Arm 14

R/L Leg 18

Armor Value

9

40

11

28

8

24

26

Weapons and Ammo

Location Critical Tonnage

PPC RA 3 7

2 Medium Lasers RT 1 1

Medium Laser RT (R) 1 1

2 Medium Lasers LT 1 1

Medium Laser LT (R) 1 1

2 Machine Guns LA 2 1

Ammo (MG) 200 LT 1 1

SRM 6 LT 2 3

Ammo (SRM) 30 LT 2 2

LGB-OW LONGBOW



"The already-imposing figure of the *Longbow* was modified in the 3060s, giving it a newer, even more powerful profile that strikes fear in its opponents."

Mass: 85 tons

Chassis: StarCorps 100 LGB

Power Plant: Strand 340

Cruising Speed: 43 kph

Maximum Speed: 64 kph

Jump Jets: None

Jump Capacity: None

Armor: StarSlab/9.5 Mk II

Armament:

2 Holly LRM 20s

2 Delta Dart LRM 5s

1 ChisComp 32 Small Laser

Manufacturer: StarCorps Industries

Primary Factory: Crofton, Loburg,
Emris IV (destroyed 3014)

Communications System: O/P 3000 COMSET

Targeting and Tracking System: Octagon Tartrac
System C

Overview

StarCorps developed the *Longbow* as a superior fire-support 'Mech and the Free Worlds League's answer to the *Archer*, which the Terran Hegemony carefully guarded during the Age of War. While the League was happy with the 'Mech, it was blindsided when StarCorps took advantage of its multinational status to supply their *Longbow* to all the Great Houses near the end of the Age of War. (Ironically, the Free Worlds League was the first House beyond the Hegemony to acquire the *Archer*.) Despite the destruction of the Succession Wars, two factories have survived to the current day, and a third has been nearly rebuilt after suffering serious damage during Duke Anton's Revolt in 3014.

While not a popular 'Mech with pilots, the availability of the *Longbow* and its spare parts has kept sales steady.

Capabilities

The *Longbow* has good speed for its size, allowing it to pace heavy and assault units alike. With fifty LRM tubes, the *Longbow* can provide superior missile support, but the small laser backup is virtually useless. While it can maintain fire with its larger launchers, the *Longbow* can't handle all of its launchers at once without overwhelming its heat sinks. And most significantly, the *Longbow's* armor is paper-thin for a 'Mech of its size, forcing a MechWarrior to keep it out of close combat.

Deployment

The *Longbow* can be found in any military of significant size. In 3039, the Free Worlds League and the Federated Commonwealth had most of the *Longbows*. StarCorps continues to sell repair parts to other entities, however, allowing the Combine, Confederation, and Periphery to maintain their stockpiles.

A Capellan counterattack on Kittery in the Third Succession War brought a lance of *Longbows* to the forefront. Providing support for *Centurions* and *Victors*, the Capellan 'Mechs fell quickly. It looked like Federated Suns would win when a lance of scout 'Mechs got through the Davion line. Unable to defend themselves against even lightly armed *Stingers*, only two *Longbows* managed to successfully retreat. The battle moved back and forth until the surviving *Longbows* returned to combat. Paired with two *Dervishes*, the *Longbows* were able to help push the Liao units off planet.

Variants

The LGB-7Q solved many of the OW's problems by utilizing a smaller Strand 255 engine. This freed up enough mass to mount over an additional five tons of armor, nine extra heatsinks, and replace the small laser with a pair of mediums. Despite these improvements, this variant never achieved the commercial success of the OW.

Notable MechWarriors

Chu-i Cedrick Sveinson: A member of the Fifth Sword of Light, Sveinson piloted his *Longbow* as the commander Sorenson's Sabres fire lance. While a good pilot, he was excel-

lent at directing fire for his lance. He was also a vocal supporter of the Rasalhague underground, and went AWOL soon after the formation of the Free Rasalhague Republic in March 3034. Tragically, Sveinson was killed by his Sabre comrades a day prior to receiving the *Kanrei's* official statement allowing anyone wanting to leave the DCMS for the KungsArmé to do so.

Type: **Longbow**

Technology Base: Inner Sphere

Tonnage: 85

Battle Value: 1,377

Equipment

Internal Structure:

Engine: 340

Walking MP: 4

Running MP: 6

Jumping MP: 0

Heat Sinks: 13

Gyro: 4

Cockpit: 3

Armor Factor: 144

	Internal Structure	Armor Value
Head	3	9
Center Torso	27	21
Center Torso (rear)		10
R/L Torso	18	18
R/L Torso (rear)		7
R/L Arm	14	9
R/L Leg	18	18

Weapons and Ammo

Weapons and Ammo	Location	Critical	Tonnage
LRM 20	RA	5	10
Ammo (LRM) 12	RT	2	2
LRM 20	LA	5	10
Ammo (LRM) 12	LT	2	2
LRM 5	RT	1	2
LRM 5	LT	1	2
Ammo (LRM) 48	CT	2	2
Small Laser	H	1	.5

MAD-4A MARAUDER II



"Although the original was imposing enough, Blackwell techs took the opportunity in the 3060s to make the *Marauder II* appear even more frightening and powerful."

Mass: 100 tons

Chassis: GM Marauder

Power Plant: Vlar 300

Cruising Speed: 32 kph

Maximum Speed: 54 kph

Jump Jets: Chilton 600

Jump Capacity: 90 meters

Armor: Valiant Lamellor

Armament:

2 Magna Hellstar PPCs

2 Magna Mk II Medium Lasers

1 Magna Mk III Large Laser

Manufacturer: GM/Blackwell

Primary Factory: New Valencia

Communications System: Dalban Micronics

Targeting and Tracking System: Dalban Hi-Rez II

Overview

In 3010 Wolf's Dragoons contracted with Blackwell Industries on New Valencia to produce a fearsome 100-ton version of the famed *Marauder* BattleMech. A little over two years later the first *Marauder II* walked into the ranks of the Dragoons' Zeta Battalion, and for most of the next twenty years the *Marauder II* was an exclusive Dragoon 'Mech. After the Fourth Succession War Jaime Wolf authorized Blackwell to increase production and allow outside buyers access, and the design spread across the Inner Sphere, although in very limited numbers. It wouldn't be until the 3060s that General Motors would license the design and begin more general production.

Capabilities

The design phase of this 'Mech was very short—Dragoon officers and the Blackwell engineers were working from existing plans, after all, and strengthening the basic *Marauder* chassis turned out to be simpler than expected. The basic weapons mix was not altered—two Hellstar PPCs are enough to threaten even an *Atlas*—but a large laser replaced the Whirlwind cannon. Thirteen extra heat sinks were mounted to allow the *Marauder II* a more ferocious rate of fire and to offset the heat of the trio of Chilton 600 jump jets. Additionally, the amount of armor was increased to match or better that of any other BattleMech on the field.

Deployment

It was not until after the Fourth Succession War that the *Marauder II* was offered for sale to any other unit except Wolf's Dragoons. During that time it was most numerous in the ranks of Zeta Battalion and Alpha Regiment, where it found enthusiastic use among assault companies and unit commanders. Enemies of the Dragoons soon learned to fear the advance of a *Marauder II*, as seeing one often meant other heavy Dragoons were nearby.

Once Blackwell began offering the 'Mech to approved buyers, it began to spread. The largest buyer was the mercenary unit Miller's Marauders, which began replacing its standard *Marauders* with *Marauder IIs*, forming an elite and powerful assault battalion. Other units bought the 'Mech in small quantities, but each buyer had to be approved by Wolf's Dragoons before the sale was allowed.

Variants

There are no known variants of the standard *Marauder II*. It is possible that individual MechWarriors have modified their 'Mechs in some way, but Blackwell supports no other models.

Notable MechWarriors

Captain Lucas Kenner: Lucas Kenner rose to command Kenner's Company of Able Battalion, Alpha Regiment of Wolf's Dragoons shortly before the Dragoons' attack on Hesperus II in 3019. Captain Kenner led his company—the lead company of the Dragoons—during the attack

and acquitted himself honorably, using his *Marauder II* to force his way through Steiner defenses. His company was responsible for most of Alpha Regiment's advances during the campaign, quieting many of the critics who'd advised that he was too young and inexperienced for such a position. Like so many other Dragoons, Captain Kenner died in the crucible of Misery against the Ryuken.

Type: **Marauder II**

Technology Base: Inner Sphere

Tonnage: 100

Battle Value: 2,073

Equipment

		Mass
Internal Structure:		10
Engine:	300	19
Walking MP:	3	
Running MP:	5	
Jumping MP:	3	
Heat Sinks:	29	19
Gyro:		3
Cockpit:		3
Armor Factor:	304	19
	<i>Internal Structure</i>	<i>Armor Value</i>
Head	3	9
Center Torso	31	45
Center Torso (rear)		16
R/L Torso	21	31
R/L Torso (rear)		11
R/L Arm	17	34
R/L Leg	21	41

Weapons and Ammo

	Location	Critical	Tonnage
PPC	RA	3	7
Medium Laser	RA	1	1
PPC	LA	3	7
Medium Laser	LA	1	1
Large Laser	RT	2	5
Jump Jet	CT	1	2
Jump Jet	RL	1	2
Jump Jet	LL	1	2

GENERAL SIZE COMPARISON CHART

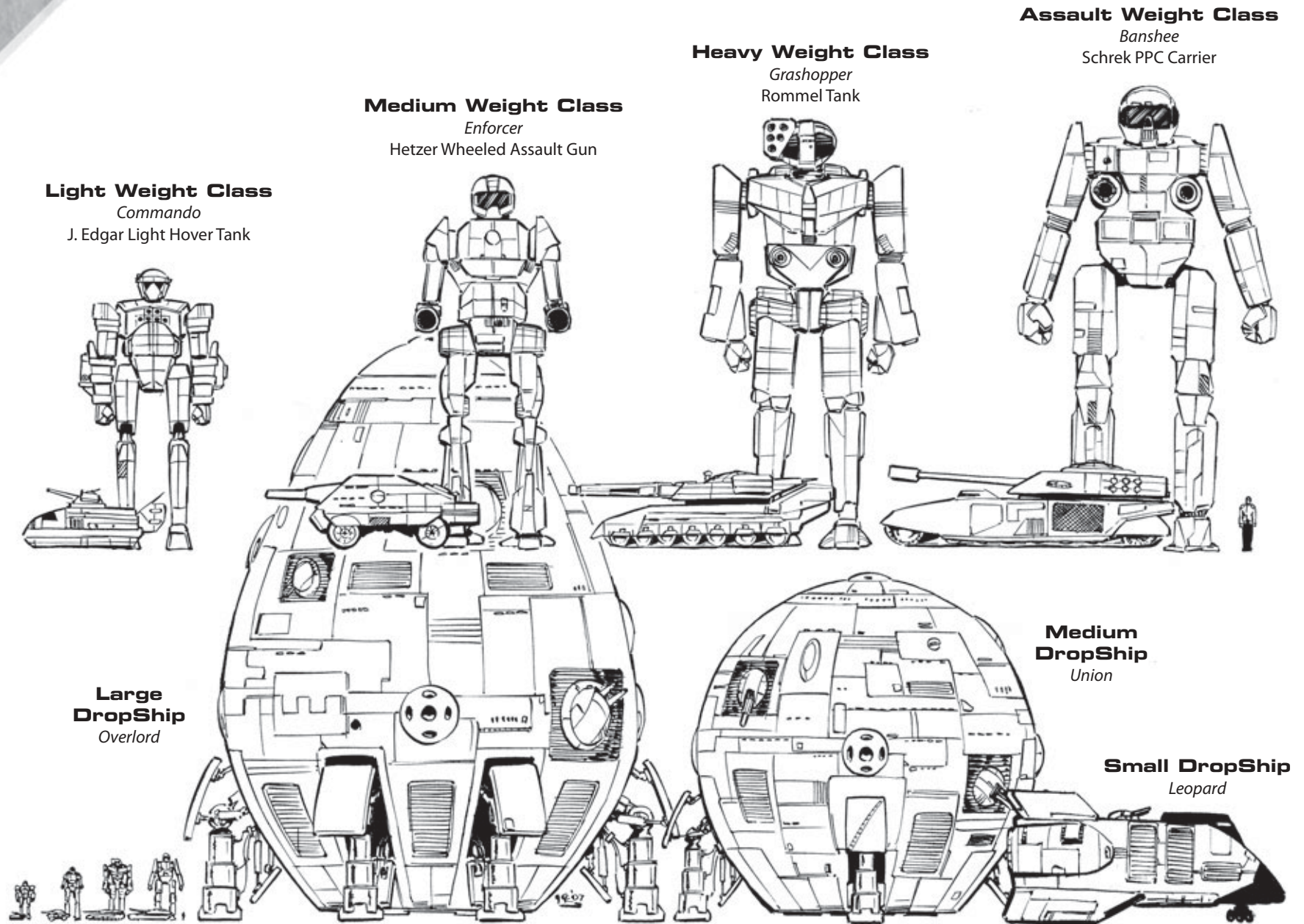

NOTE: Although size varies individually among units, this scale shows the relative size difference in each weight class.

CLASSIC BATTLETECH™

CLASSIC BATTLETECH ERAS

The *Classic BattleTech* universe is a living, vibrant entity that grows each year as more sourcebooks and fiction are published. A dynamic universe, its setting and characters evolve over time within a highly detailed continuity framework, bringing everything to life in a way a static game universe cannot match.

However, the same dynamic energy that makes *BattleTech* so compelling can also make it confusing, with so many sourcebooks published over the years. As people encounter *BattleTech*, get hooked and start to obtain sourcebooks, they need to know where a particular sourcebook is best used along the *BattleTech* timeline.

To help quickly and easily convey the timeline of the *Classic BattleTech* universe—and to allow a player to easily “plug in” a given sourcebook—we’ve divided *Classic BattleTech* into five major eras. (For those that own the *Classic BattleTech Introductory Box Set*, the year dates in parentheses following each era’s title correspond to the maps found in the *Inner Sphere at a Glance* sourcebook.)

STAR LEAGUE (2570)

Ian Cameron, ruler of the Terran Hegemony, concludes decades of tireless effort with the creation of the Star League, a political and military alliance between all Great Houses and the Hegemony. Star League armed forces immediately launch the Reunification War, forcing the Periphery realms to join. For the next two centuries, humanity experiences a golden age across the thousand light-years of human-occupied space known as the Inner Sphere. It also sees the creation of the most powerful military in human history.



SUCCESSION WARS (3025, 3030, 3040)

Every last member of First Lord Richard Cameron’s family is killed during a coup launched by Stefan Amaris. Following the thirteen-year war to unseat him, the rulers of each of the five Great Houses disband the Star League. General Aleksandr Kerensky departs with eighty percent of the Star League Defense Force beyond known space and the Inner Sphere collapses into centuries of warfare known as the Succession Wars that will eventually result in a massive loss of technology across most worlds.



CLAN INVASION (3052, 3057)

A mysterious invading force strikes the coreward region of the Inner Sphere. The invaders, called the Clans, are descendants of Kerensky’s SLDF troops, forged into a society dedicated to becoming the greatest fighting force in history. With vastly superior technology and warriors, the Clans conquer world after world. Eventually this outside threat will forge a new Star League, something hundreds of years of warfare failed to accomplish. In addition, the Clans will act as a catalyst for a technological renaissance.

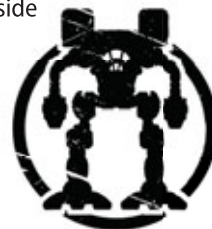

CIVIL WAR (3062, 3067)

The Clan threat is eventually lessened with the complete destruction of a Clan. With that massive external threat apparently neutralized, internal conflicts explode around the Inner Sphere. House Liao conquers its former Commonality, the St. Ives Compact; a rebellion of military units belonging to House



Kurita sparks a war with their powerful border enemy, Clan Ghost Bear; the fabulously powerful Federated Commonwealth of House Steiner and House Davion collapses into five long years of bitter civil war.

JIHAD

Following the Federated Commonwealth Civil War, the leaders of the Great Houses meet and disband the new Star League, declaring it a sham. The pseudo-religious Word of Blake—a splinter group of ComStar, the protectors and controllers of interstellar communication—launch the Jihad: an interstellar war that will ultimately pit every faction against each other and even against themselves, as weapons of mass destruction are used for the first time in centuries while new and frightening technologies are likewise unleashed.



SOURCEBOOKS

As Catalyst Game Labs continues to publish new *Classic BattleTech* products (and reprint previously published products), easy reference logos—corresponding to those above—will be printed directly on their back covers. This will allow retailers and players alike to know at a glance what eras are covered by a given product. For additional ease of reference, era logos will also appear on product’s sell sheet, on-line products page and so on.

Note that if a Catalyst Game Labs’ *Classic BattleTech* product does not contain an era logo, then it is considered a core rulebook or supplement to be used across all eras, such as the *Introductory Box Set*, *Total Warfare* and so on.